

Number 3
Volume XLVI

DECEMBER, 1913

\$2.00 per year
\$3.00 with Directory

TEXTILE WORLD RECORD

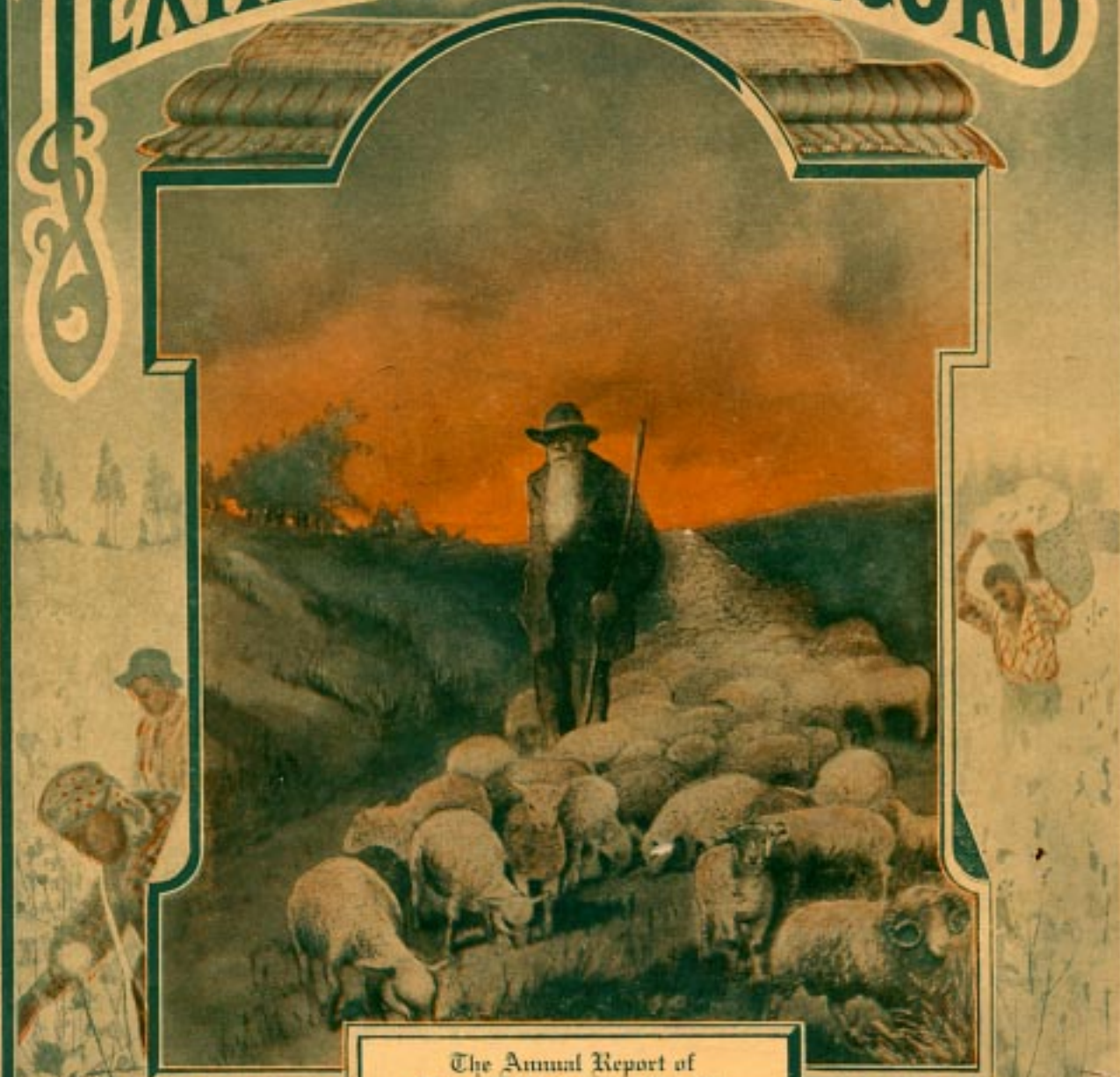

The Annual Report of
New Mill Construction for
1913, in this issue

LORD & NAGLE CO., BOSTON, MASS.

Table of Contents Page 51

Buyers Index Page 147

Index to Advertisements Page 157

The **TEXTILE-FINISHING MACHINERY CO.**

Howard Building, Providence, R. I.

BUILDERS OF

**Singeing, Bleaching, Mercerizing, Dyeing, Drying,
Printing and Finishing Machinery**

FOR

TEXTILE FABRICS AND WARPS

Plans and Estimates for Complete Plants

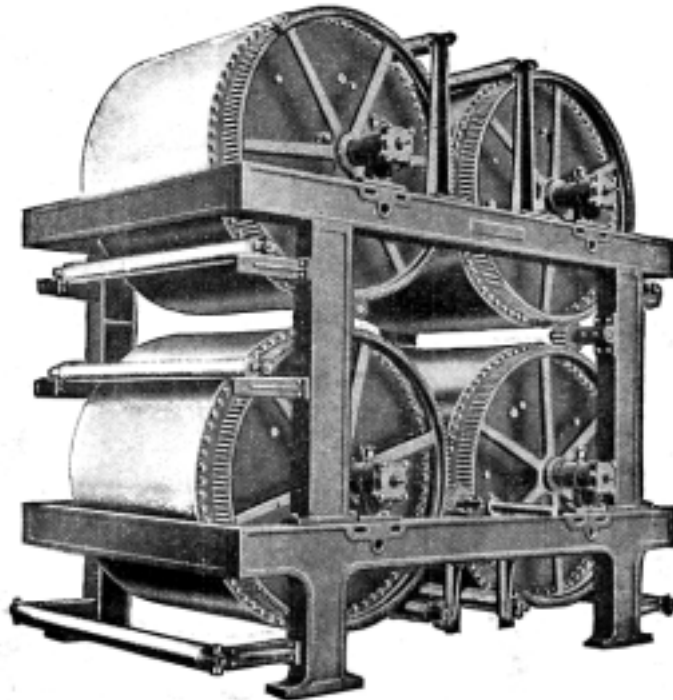

Back Dryer

ALL KINDS OF

Horizontal and Upright Drawing Machines

With cylinders made from either the best English tinned
iron or best Lake Superior sheet copper, fitted with our

Patent Spiral Scoops

H. W. BUTTERWORTH & SONS CO.

PHILADELPHIA, PA.

Providence Office, Room 417, Industrial Trust Building.

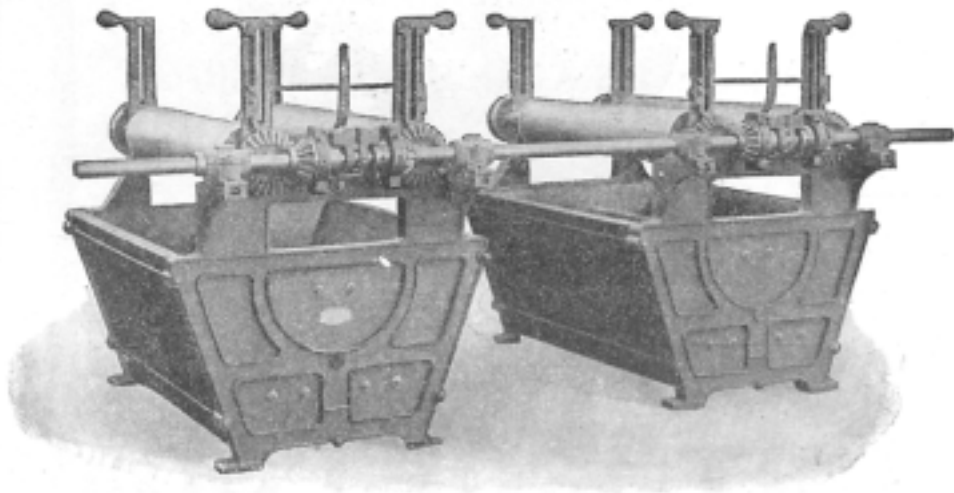

JIGGER

**Bleaching, Drying,
Dyeing and Finishing
Machinery**

for all textile fabrics.

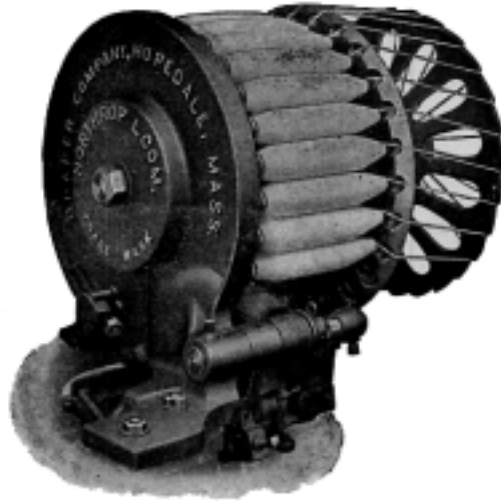

NORTHROP LOOMS

TRADE MARK REGISTERED

EARN More Wages for the Weaver
Larger Dividends for the Mill

DRAPER COMPANY
HOPEDALE MASS.

The Rabbeth Centrifugal Clutch Spindle



Carries Bobbins at Uniform
Level.

Produces more even twist.

Filling bobbins carry ten
per cent. more yarn.

The only real improvement in
spindles for years.

DRAPER COMPANY

HOPEDALE, MASS.

J. D. CLOUDMAN, Southern Agent, 40 So. Forsyth St., Atlanta, Ga.

The Foster Cone Winder

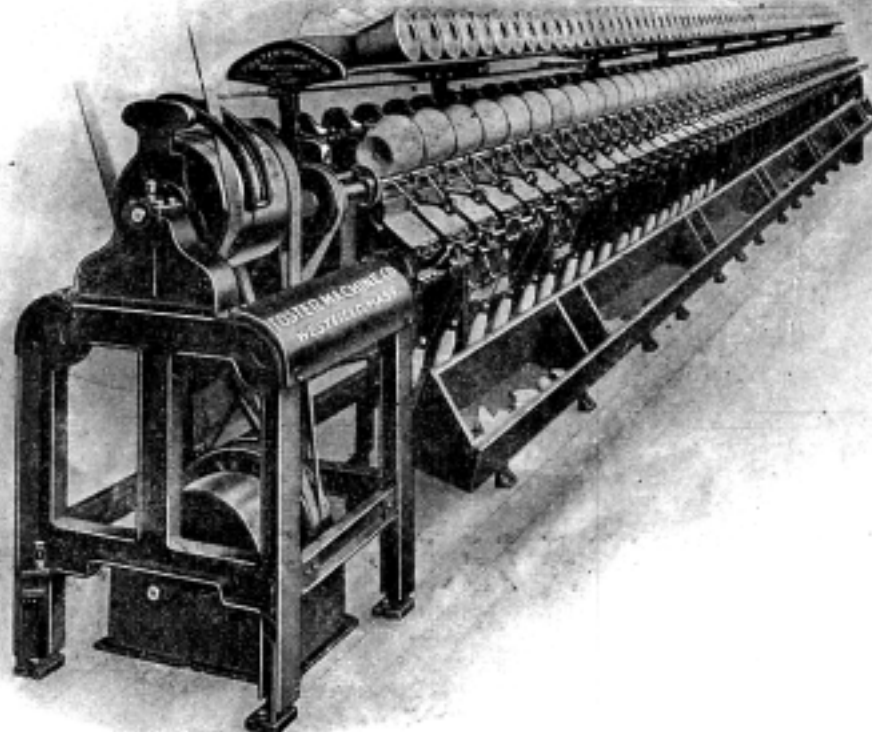

The cone package has attained its present favor through the extension of the use of the Foster Cone Winder.

Foster finishing has eliminated cobwebbed cones, ribbon wind chafing, loose ends and guide rubbed cones.

75 per cent of all the knitting yarns produced in the United States are wound on this machine.

Foster Machine Company

Westfield, Mass.

John Hill, Southern Agent, 3rd National Bank Building, Atlanta, Ga.

Saco-Lowell Shops

We manufacture

Cone and Tube Winders

For Cotton—Woolen—Worsted Yarns

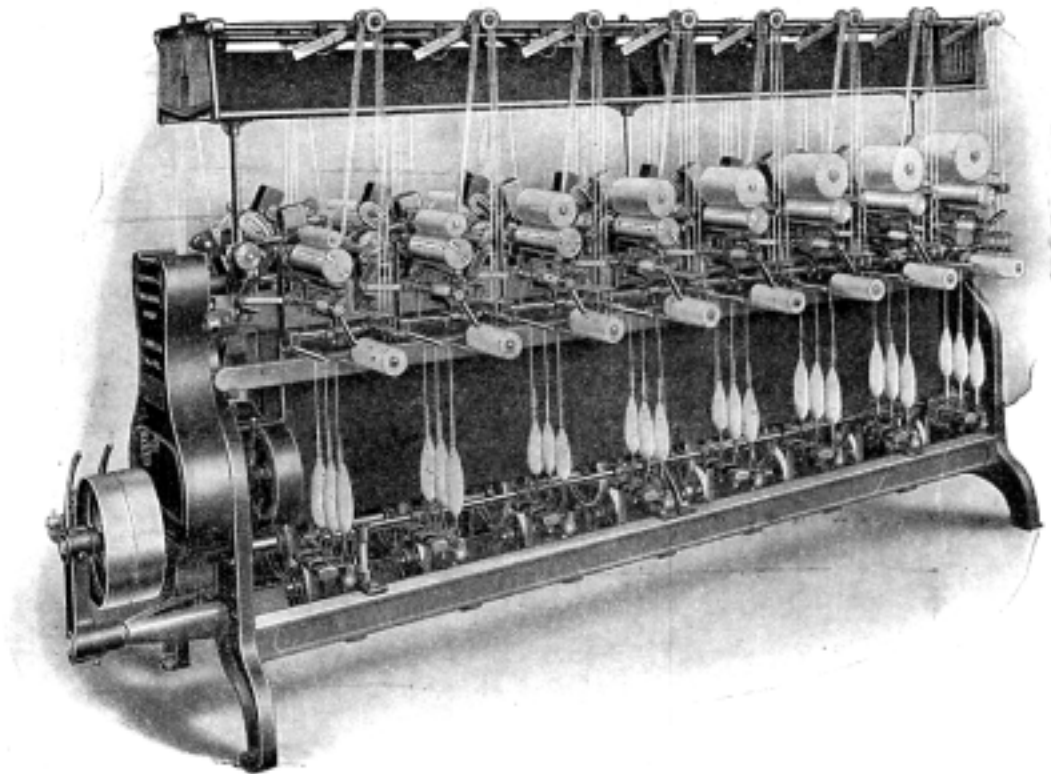

We can reasonably claim—

High Spindle Efficiency
Low Labor Cost
Improved Mechanical Design

Shops: Biddeford, Me., Lowell, Mass., Newton Upper Falls, Mass.
Executive Offices: 77 Franklin Street, Boston, Mass.
Southern Agent: Rogers W. Davis, Charlotte, N. C.

The Whitin Machine Works

Whitinsville, Mass.

BUILDERS OF

Cotton Mill Machinery

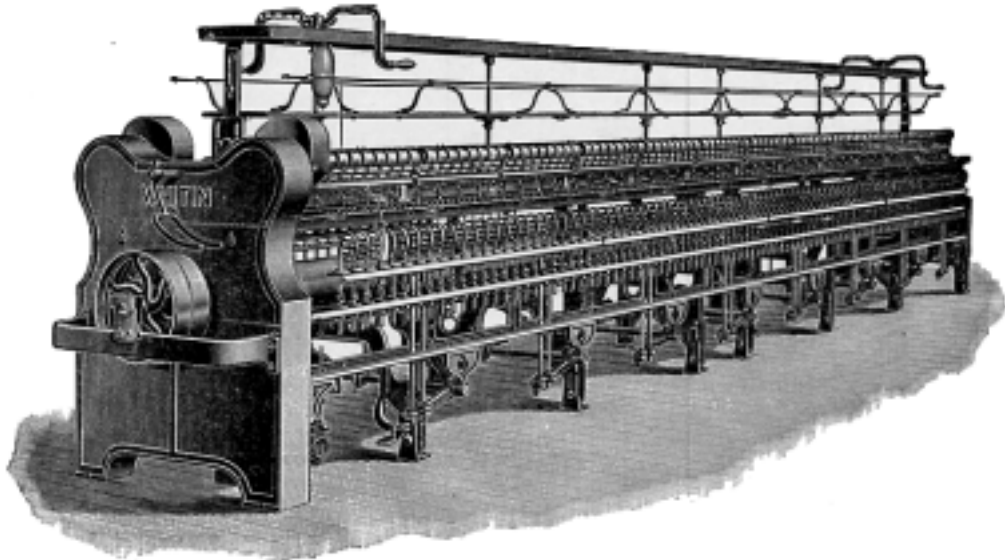

Ring Spinning Frame

CARDS
COMBERS
DRAWING FRAMES
ROVING FRAMES
SPINNING FRAMES

SPOOLERS
TWISTERS
REELS
LONG CHAIN QUILLERS
LOOMS AND DOBBIES

Southern Agent: STUART W. CRAMER, Charlotte, N. C.



A cold snap! That means trouble at the mill with fibers, yarns and machinery. Then consider that there are many mills running as smoothly as on a balmy spring day. They are the *Carrier Equipped* mills. Want your catalog now?

Carrier Air Conditioning Co.

Of America

No. 39 Cortlandt Street, New York City

NEW ENGLAND
E. T. Lyle, 1862 Beacon St.
Brookline, Mass.

CHICAGO
Ft. Dearborn Bldg.
Clark and Monroe Sts.

PHILADELPHIA
732 Real Estate Trust
Bldg.

BUFFALO, 490 Broadway



LEIGH & BUTLER

SUCCESSORS TO

EVAN ARTHUR LEIGH

232 Summer Street (opposite the South Station), Boston, Mass.

SOLE AGENTS

IN THE UNITED STATES AND CANADA FOR

Platt Bros. & Co., Ltd.

BY FAR THE LARGEST MAKERS IN THE
WORLD OF

Cotton,
Woolen and Worsted
Machinery

Platt's Patent Opening and Picking Machinery.

Platt's Cotton Comber — will comb from 7-8" stock to Sea Islands.

Platt's Special Machinery for Making Cotton Waste into Yarns.

Platt's Special Machinery for Making French Worsted Yarns.

Platt's Woolen and Worsted Carding Engines, Special Designs.

Platt's Cotton, Cotton Waste, Woolen and Worsted Mules.

MATHER & PLATT, LTD.

Dyeing and Finishing Machinery.

Archbutt-Deeley System for purifying and softening water.

JOSEPH SYKES BROS. Card Clothing for Cotton.

JAMES CRITCHLEY & SONS. Card Clothing for Woolen and Worsted.

WILSON BROS. BOBBIN CO. Bobbins, Shuttles, Etc.

THOMAS B. HAIGH. Double Loop Bands, Spinning Tape, Etc.

DRONSFIELD BROTHERS. Grinding Machinery and Emery Filleting.

HARDING'S Fallers, Pins and Circles.

The Best French and English Combing and Rubbing Aprons.

Card Flats reclothed and Lickers-in rewound.

UNIVERSAL WINDING MACHINES



PARTS ALL INTERCHANGEABLE



Leeson



TRADE MARK REG. U.S. PAT. OFF.



RECENT INSTALLATION OF "UNIVERSAL" FILLING WINDERS

UNIVERSAL WINDING COMPANY
PATENTEES AND SOLE MANUFACTURERS
BOSTON



The History of a Factory Ceiling

(From actual photographs)

Painted with a cold-water paint

Flaked off until it looked like A.

Scraped and painted with Rice's Mill White.

The durable, lasting qualities of Rice's Mill White are shown by the following extract from a letter of the General Fire Extinguisher Co.

"We are *still pleased* with the finish of Rice's Gloss Mill White, which was applied on the ceilings and walls of our Auburn Plant *three years ago.*"

RICE'S MILL WHITE

is an **oil** paint, containing no varnish, giving a **glossy**, tile-like finish. It will not craze, crack or scale under the jar of machinery. It stays white longer than any other gloss paint.

We were the originators of "Mill White" Paint. None of its imitations have the elastic, durable qualities which made the reputation of "Mill White" Paint.

Rice's Mill White Paint is sold direct, in barrels containing sufficient paint to cover 20,000 square feet, one coat. If you have that area of ceiling and wall space to cover,

Write for Booklet and Sample Board

Ask for a copy of our booklet, "More Light." *Write today.*

U. S. GUTTA PERCHA PAINT CO., 20 Dudley St., Providence, R. I.

MASON MACHINE WORKS

Taunton, Mass.

Greenville, S. C.

*Builders of
Revolving Flat Cards, Drawing Frames,
Spinning Frames, Looms, Dobbies, Etc.*

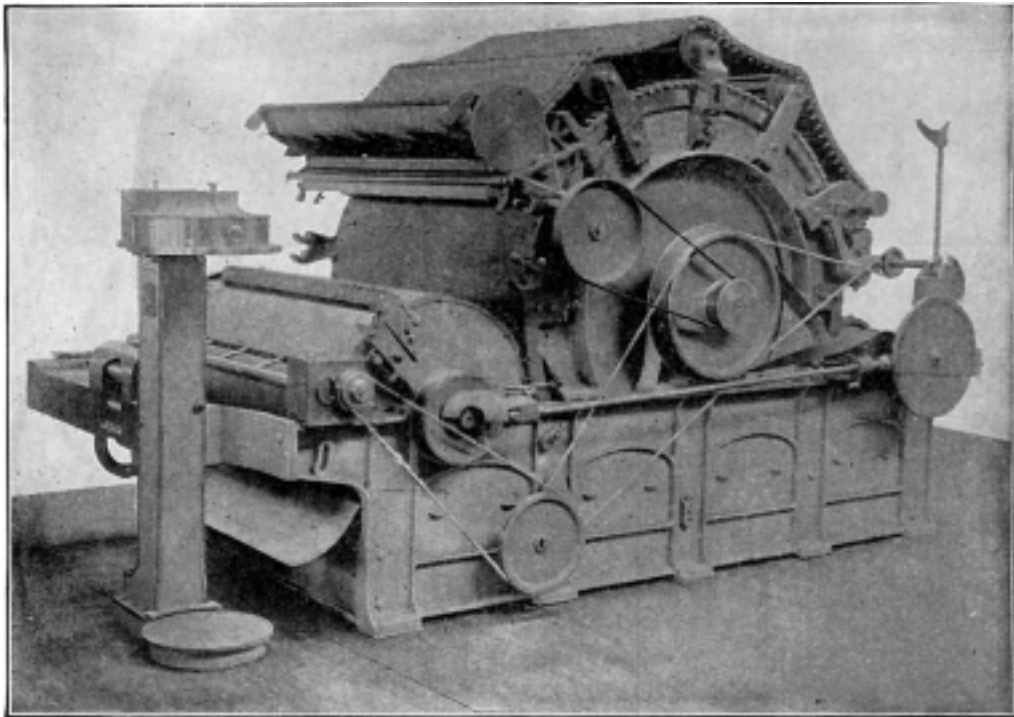

Superior Loom Cranks for Repairs



Another recent installation

400 "Ideal" Automatic Looms

on 5 harness sateens

These looms were installed as the result of a test during which the superiority of Stafford Looms over all competitors was clearly demonstrated

THE STAFFORD COMPANY

READVILLE, MASS.

FRED H. WHITE, Southern Agent - - Charlotte, N. C.

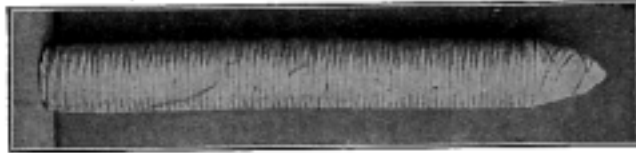

No. 2

No. 1 and No. 2—Cops to weave from inside seven-eighths to three inches diameter and up to seventeen inches long.

Suitable for various kinds of coarse goods such as grass matting, cotton bagging, cocoa matting, all kinds of carpets, felts, chinchilla, linen, jute, flax, asbestos, hose and narrow fabrics such as wicks, belting, webbing, surcingles, halters, etc.



No. 1

No. 3 and No. 4 Shuttle Bobbins from seven-eighths to two inches in diameter and any length up to twelve inches. Suitable for all kinds of duck, upholsteries, tapestries, asbestos, ratana or any kind of fancy yarns for automatic or other looms.



No. 4

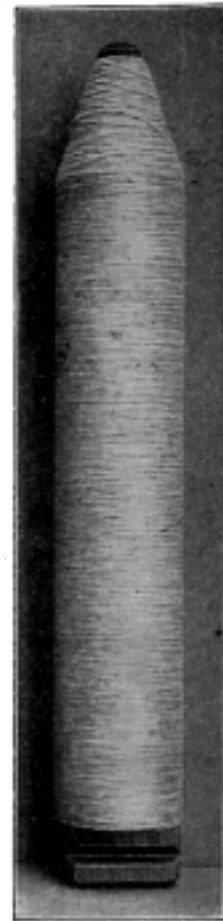

No. 3

OSWALD LEVER CO., Inc.

Lehigh Avenue and Front Street, Philadelphia, Pa.

Builders of Textile Machinery

**WINDERS
ESPECIALLY**

Crompton & Knowles Loom Works

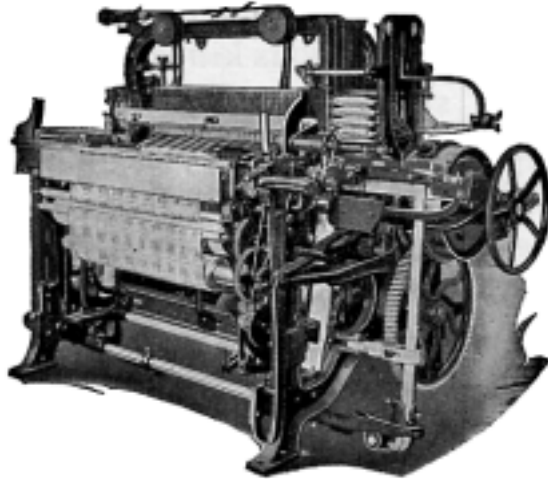

Automatic Gingham Looms

One of our latest productions for weaving goods of two or more colors in the filling. Like every loom we build, it has the advantage of a successful mill test.

WORCESTER, MASS.

Providence, R. I.

Philadelphia, Pa.

Southern representative, ALEXANDER & GARSED, Charlotte, N. C.

The Yarn Conditioning Machine

Sets the twist in your filling and overcomes kinky filling difficulties. It conditions without injuring the bobbins

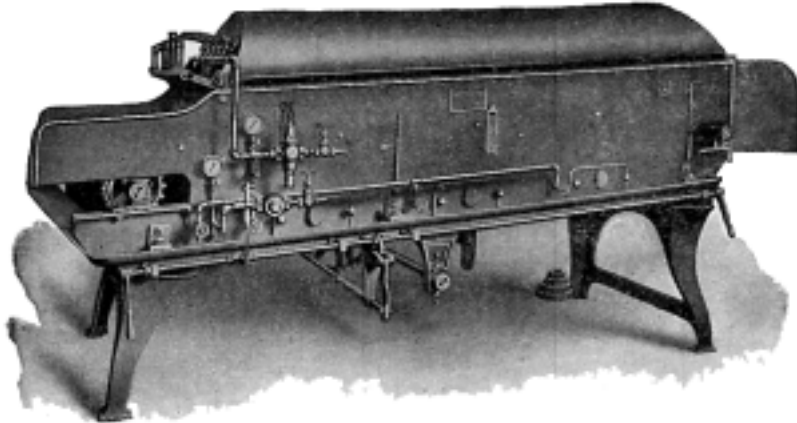

The Sargent Drying Machines

**Metal Construction
Asbestos Insulation**

*Scientifically designed for greatest economy in
drying Cotton, Wool, Hair.*

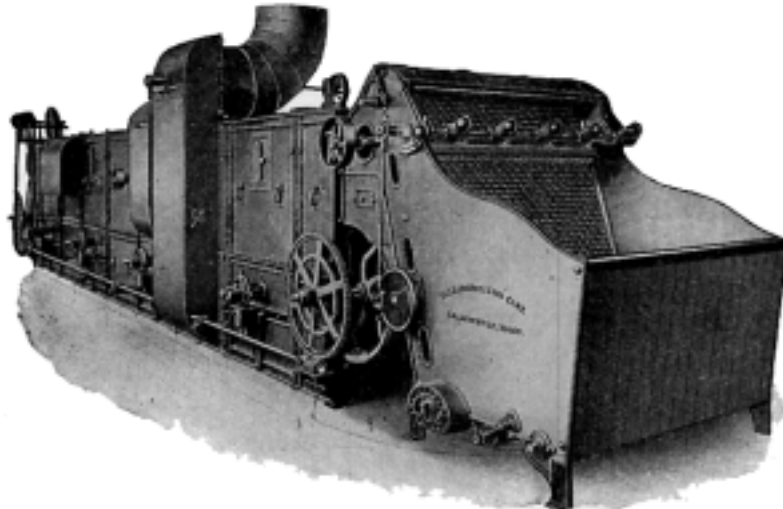

**Wool Washers, Wool Dusters and Openers, Burr Pickers
Complete Carbonizing Plants
Automatic Feeds for Cotton and Wool**

C. G. Sargent's Sons Corp., Graniteville, Mass.



A Satisfied Customer Is — And Writes — A Good Advertisement

A Turbo user wrote "the body" for this ad. He didn't intend it as an advertisement. But it is, in itself, good evidence of the Turbo's efficiency in service and low cost of upkeep.

And that's why we think it a good advertisement. Do you agree with us?

Upkeep Cost 37c. for 365 Days

"We have just laid out a routine for the care of the Humidifiers and have put a section of the work through and obtained our costs from this as follows:

Our Compressor Cylinder opened every three months and cleaned	\$2.13
General cleaning of all heads in system every six months	8.00
Special attention	12.00

Cleaning water filters on tanks and water jacket of Compressor	... \$7.20
Total cost of labor for year (79 heads) 29.33

"We find that this system keeps the heads all in A1 condition all of the time and while we have just instituted the work, we may find that later we can cut these figures."

A MASSACHUSETTS MILL.

You see the letter is full of "reason-why" argument in favor of the Turbo—and we have a bunch of others just as eloquent.

Ask for a Turbo Catalog, or a Turbo Engineer—you may send for either or both without obligation.

The G. M. Parks Company

Fitchburg, Mass.

Southern Office, 32 West Trade St., Charlotte, N. C. B. S. Cottrell, Mgr.

DEPT. A

DEPT. B

ENTRANCE AND EXIT

LADIES

MARKED SPACES ARE SOLD

WHAT SPACE SHALL WE MARK FOR YOU?

Fourth National Textile Exhibition

Cotton, Woolen, and Knitting Machinery, Power and Mill Construction Departments,

MECHANIC'S BUILDING, BOSTON. APRIL 27 to MAY 2, 1914

Send for list of those who have already engaged space.

CHESTER I. CAMPBELL, Sec'y and General Manager. 5 PARK SQUARE, BOSTON.

Dyeing Machinery

For
**Hosiery,
Skein Yarn,
Slubbing, etc.**

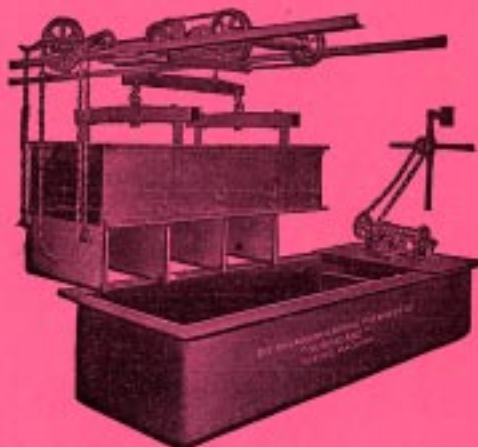

**BETTER
Dyeing
AT
Less Expense**

The **BEST** and
**Most Economical
Dyeing Machine**

Give us an
Opportunity to
Prove our claims

"Hurricane" Circulating Dyeing Machines are built in various sizes and types



Automatic Dryer for
Yarn, Slubbing, Etc.

COMPLETE EQUIPMENTS FOR
**DYEING
SCOURING
BLEACHING
CARBONIZING**

FIRE-PROOF DRYERS

Steel Construction, -Insulated with Asbestos



Power Screw and Hydraulic
PRESSES

FANS
MOTOR
AND
BELT-DRIVEN

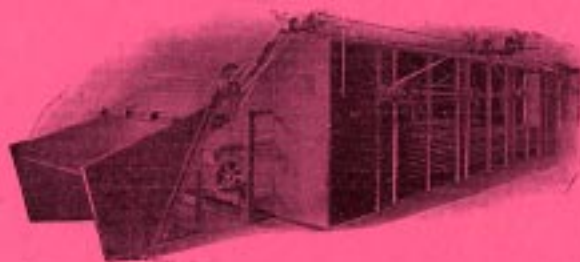

AUTOMATIC STOCK DRYER

(With Sectional-Continuous Conveyor)

For Cotton, Wool, Hair, Rags, Etc.

THE PHILADELPHIA DRYING MACHINERY CO.

Main Office and Works:
672 I Germantown Ave., Philadelphia, Pa.

Boston Office:
53 State Street

THOMAS LEYLAND & COMPANY

F. T. Walsh, Manager

60 India Street, Boston, Mass. WORKS AT READVILLE, MASS.

Sole Manufacturers of THE WILLIAM WYCOCK

Improved Regulating Cloth Expander

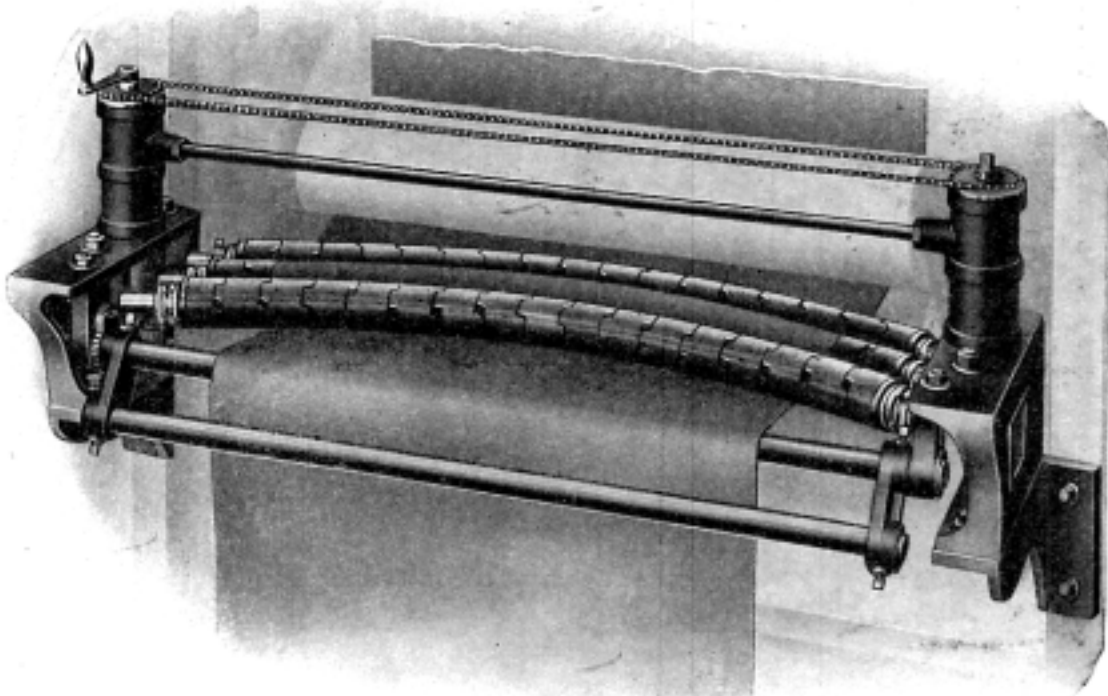

Expander attached to Calendar showing Regulating Motion and Adjustable Tension Bars

This Expander and its improved features are fully protected by basic United States patents, under which the builders will maintain their patent rights against any who may violate such rights by building, selling or using machines of this character.

Scutchers, Sewing Machines, Open Bleaching Machines, Blanket Washers
for Calico Printers, Guides, Etc.

Cotton Machinery by Specialists

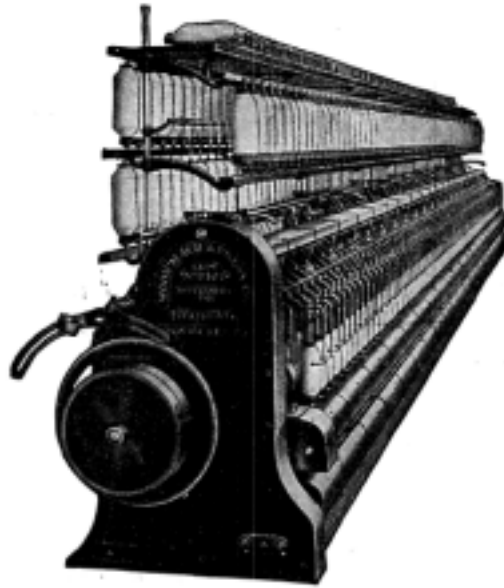

With Latest Improvements

Maximum of Efficiency

Minimum of Repairs

Woonsocket Machine & Press Company

Southern Representative :
J. H. MAYES, Independence Bldg.
Charlotte, N. C.

Northern Representative :
WM. V. THRELFALL, Marshall Bldg.
Boston, Mass.

Cotton Machinery by Specialists

Pickers and Revolving Flat Cards

POTTER & JOHNSTON MACHINE CO.

Pawtucket, R. I.

Drawing and Roving Machinery

WOONSOCKET MACHINE & PRESS CO.

Woonsocket, R. I.

Ring Spinning and Twisting Frames

FALES & JENKS MACHINE CO.

Pawtucket, R. I.

Spoolers, Winders and Reels

EASTON & BURNHAM MACHINE CO.

Pawtucket, R. I.

Warpers and Beamers

T. C. ENTWISTLE CO.

Lowell, Mass.

Southern Representative:
J. H. MAYES, Independence Bldg.
Charlotte, N. C.

Northern Representative:
WM. V. THRELFALL, Marshall Bldg.
Boston, Mass.

Lane Canvas Mill Baskets Boxes or Trucks

Found in the Largest and Most
Modern Mills

BECAUSE

Durability

Smoothness

Lightness

Economy



Lane Canvas Truck.
Made as shown, or with canvas parti-
tion. Mounted on improved Thread
Guard Wheels, as above, or on swivel
casters. Leather bound rim. Heavy
duck.



FIG 49

Lane Basket Frame of Tough
Spring Steel.
Renewable Hard Maple Shoes.
Also furnished with steel shoes,
where dragging is not severe.
Number and diameter of frames
varies with size of baskets.

COUNT

A Style for Every Use

W. T. Lane & Brother

Manufacturers

Poughkeepsie

New York

The "HOFFMAN" "FFF" Underwear Press

Can be adjusted to the requirements of the Press room—so as to give the desired finish to any class or style of underwear.

This adjustment is regulated by a very simple movement of the wrist.

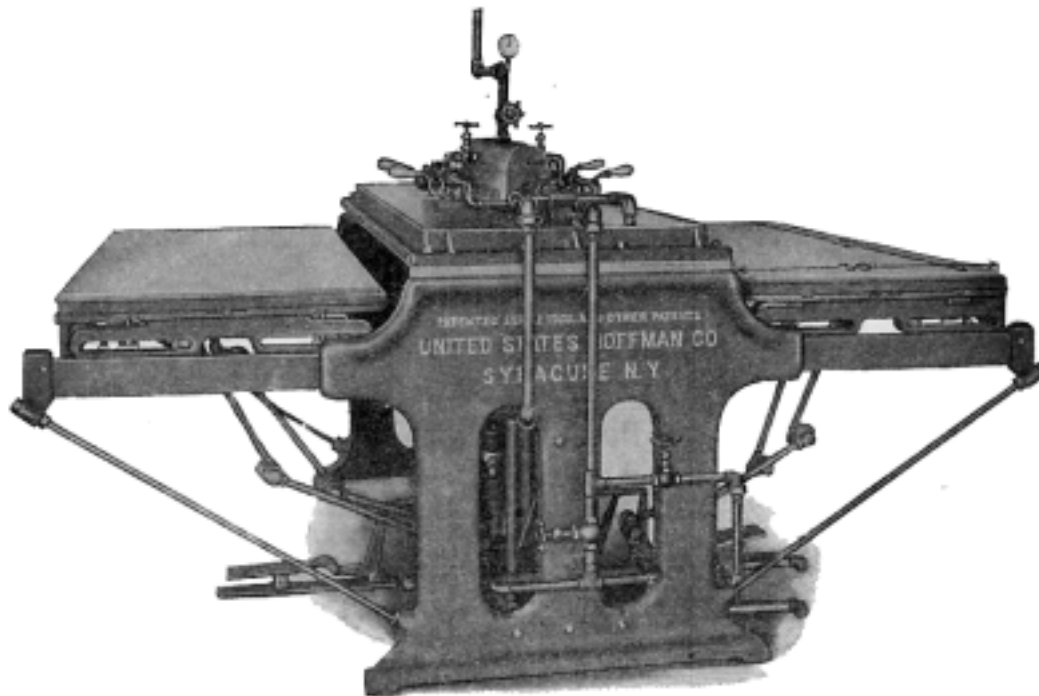

"HOFFMAN" "FFF" Underwear Press

The principle of the "HOFF-MAN" is the application of LIVE DRY Steam to the garment FROM ABOVE while under pressure—giving it a very superior finish.

United States Hoffman Co.

SYRACUSE, N. Y.

Write for information

SPECIAL MILL SUPPLIES THAT HELP INCREASE PRODUCTION

New Hand Threading Shuttle

This new patented shuttle is the simplest, most effective, and quickly threaded shuttle made. It can be operated with the finest silk or the coarsest filling—will not unthread—it is arranged so that lint may be easily removed, and so that felt can be inserted for tension purposes. It complies with the Massachusetts sanitary shuttle law.

Never-Slip Cop Spindles and Tubes

We can guarantee that with this combination you can run your looms faster and with longer cops than with any other spindles or tubes. With this arrangement there is no waste of filling.

Paper Cop Tubes, Cones and Shells

We make a complete line of these, all of the very finest quality—samples sent free on request.

Shuttles and Shuttle Irons

MADE FOR ALL TEXTILE PURPOSES

When in need of any of these products, all of which are fully patented and protected, give us a trial order— we can guarantee you complete satisfaction.

American Textile Specialty Machinery Co.

670 Eddy Street, - Providence, R. I.

Also 13th St. and Boulevard, Long Island City

The Most Useful Power for the Least Money---From Any Source

Comparing the mechanical lineshaft drive from engine with the G-E individual motor drive, brings out general truths applicable to every industry. Every man wanting more power, or desiring to pay less for power, should read these comprehensive facts:

More power can be generated from a given amount of coal, over extended periods with less maintenance, by using a Curtis Steam Turbine than with any other power equipment. You get maintained efficiency without constant valve grinding and repairs due to many moving parts.

More useful power can be generated from a given amount of water, oil, sun or wind power where the power is to be conveyed any considerable distance, by G-E generators than with any other equipment.

More power can be obtained at the place where it is to be used with electric transmission, if the distance is considerable than with any other form of power transmission. This is due to the high efficiency and long life of G-E generators coupled with the elimination of power losses in transmission due to steam condensation, lineshaft friction and belt slippag

It will be profitable for you to consult us. The assistance of any part of our organization in solving your power problems is extended to your local power company, or our nearest motor agency.

General Electric Company

Largest Electrical Manufacturer in the World

Atlanta, Ga.
Baltimore, Md.
Birmingham, Ala.
Boise, Idaho.
Boston, Mass.
Buffalo, N. Y.
Butte, Mont.
Charleston, W. Va.
Charlotte, N. C.
Chattanooga, Tenn.
Chicago, Ill.
Cincinnati, O.
Cleveland, O.
Columbus, O.
Davenport, Iowa.

General Office:
Schenectady, N. Y.



Dayton, O.
Denver, Colo.
Detroit, Mich.
(Office of Agent.)
Elmira, N. Y.
Erie, Pa.
Fort Wayne, Ind.
Hartford, Conn.
Indianapolis, Ind.
Jacksonville, Fla.

Joplin, Mo.
Kansas City, Mo.
Keokuk, Iowa.
Knoxville, Tenn.
Los Angeles, Cal.
Louisville, Ky.
Mattoon, Ill.
Memphis, Tenn.

Address
Nearest Office

Milwaukee, Wis.
Minneapolis, Minn.
Nashville, Tenn.
New Haven, Conn.
New Orleans, La.
New York, N. Y.
Niagara Falls, N. Y.
Omaha, Neb.
Philadelphia, Pa.
Pittsburgh, Pa.

Portland, Ore.
Providence, R. I.
Richmond, Va.
Rochester, N. Y.
Salt Lake City, Utah.
San Francisco, Cal.
St. Louis, Mo.
Schenectady, N. Y.
Seattle, Wash.
Spokane, Wash.
Springfield, Mass.
Syracuse, N. Y.
Toledo, Ohio.
Washington, D. C.
Youngstown, O.

For Texas, Oklahoma and Arizona business refer to Southwest General Electric Co., (formerly Hobson Electric Co.)—Dallas, El Paso, Houston and Oklahoma City.

For Canadian business refer to Canadian General Electric Company, Ltd., Toronto, Ont.

4378

BALL ~ HB DWF BEARINGS

The Hess-Bright Manufacturing Company
Pioneers in the introduction of Annular Ball Bearings

Most extensive resources and plants in existence devoted exclusively to ball bearing manufacture

Main Offices and Plant No. 2 on line of Penna. R. R. to New York
 No. 27 E. Erie Ave., Philadelphia, Pa.

A Line in Your Plant is a Convincing Argument

PHILADELPHIA 666 North Broad Street
 NEW YORK 1974 Broadway
 CHICAGO 1800 Michigan Avenue

PLANT No. 1 BERLIN, GERMANY

PLANT No. 2 PHILADELPHIA, PENN.



DRIVING SIDE

NO. 10
FULLING
MILL

GEAR DRIVE

CLOTH WASHERS



BELT DRIVE

PEICE DYE
KETTLES

SOAPING
MACHINES



ROPE DRIVE

JAMES HUNTER MACHINE CO.
NORTH ADAMS, MASS., U. S. A.



Starch

THE particular case of your own mill needs careful study to determine what starch is best suited to *your* SIZING and FINISHING problems.

We have reduced the manufacture of starches for textile work to a science by years of factory investigation and laboratory research. We are ready to take up the special case of your mill and point out to you what starches are most adaptable and reliable for your purposes.

Six years of careful investigation of conditions in the cotton mills of the country has taught us the needs of the trade.

Six years' research in the best equipped Starch Laboratory in America has put us in touch with starch chemistry.

Six years of manufacturing, with cotton mill problems in mind, has produced our special Brands of Textile Starches.

We want to send our special starch expert to your mill. We want him to go into the matter of sizing with your boss of slashing—check up your sizing processes—find out whether you are now using the starches that will insure you the most efficient and economical results.

This special starch expert service is absolutely free—send us a sample of the starches you are using. We will give you an exact analysis of them and send our practical man to study your needs. Write a letter now to our Mill Starch Department.

Corn Products Refining Company
NEW YORK

Starch

NEEDLESS GEAR NOISES CONDEMNED BY A PROMINENT ENGLISH EDITOR

One after another, editors the world over, are condemning gear noises. Surely the subject is worth every factory owner's attention. Here is what Engineering Review of London has just said editorially :

"Being absorbed in the development itself, the engineer does not worry about what he regards as an inevitable sequel. It is not until he is forced by public outcry or by actions for nuisance that he takes real trouble to reduce noise and vibration. But it may be worth his while to consider that a great deal of the public opposition to the extended application of mechanical inventions is inspired by the dislike of noise. If railways, tramways and motor vehicles were silent, they would not be the object of so much antagonism. A great deal has already been done to secure quieter running on rails and on roads, but the fact remains that traffic is still too noisy. It may also be asserted that hosts of industrial processes are too noisy. Only the most superficial attention is given to the damping of noise and vibration. Little or no consideration is given to the fact that both noise and vibration are indications of wasted energy, besides being aggravating causes of wear and tear. It is impossible, of course, to eliminate noise from the rapid movement of machinery, but it is a long way from such an admission to the deduction that it is not worth while troubling to keep it at a minimum. We believe that a good case could be made out of the systematic minimising of noise and vibration, on the score of increasing the health and efficiency of employees, and also on that of economising power and lengthening the life of machinery."

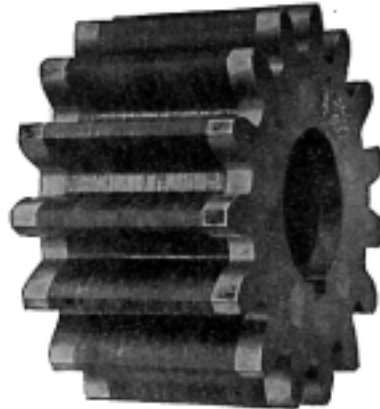

Under NO conditions are noisy metal-to-metal gear drives desirable.

Among the quiet metal-to-rawhide drives, twenty years of tests have proven New Process Noiseless Pinions are the most durable; also the most suitable for heavy duty.

A trial would soon demonstrate dollars and cents benefit to the factory owner as well as comfort to the operatives.

Our plant is the world's largest devoted exclusively to gear making, and if your high speed transmissions can be quieted, we certainly can help you.

Ask for book "Noiseless Gear Driving"

NEW PROCESS IS TO ALL OTHER RAWHIDE AS STEEL IS TO IRON



NEW PROCESS GEAR CORPORATION

SYRACUSE, N. Y.



Canadian Agents: Robert Gardner & Son, Ltd., Montreal

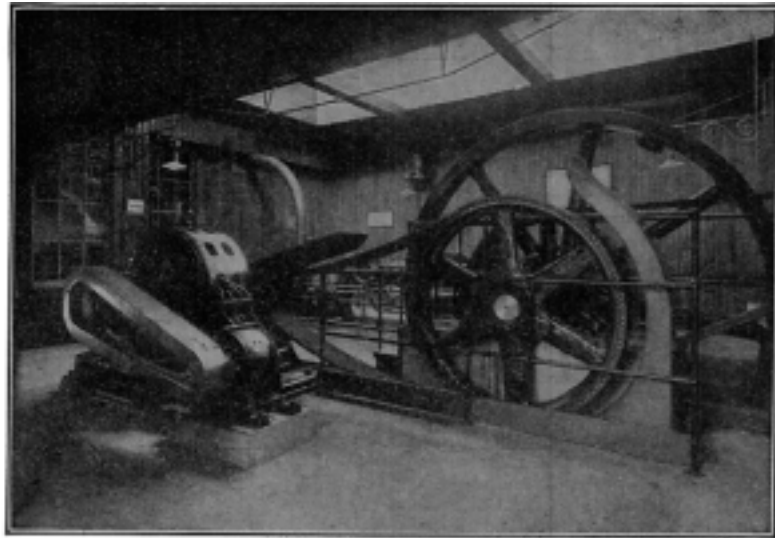

We have in the past months shown you a few of the
**SPECIAL APPLICATIONS OF MORSE FLEXIBLE GEARING
 IN TEXTILE MILL SERVICE**

Such as Spinning Frame Drives and Line Shaft Drives

BUT DO NOT

lose sight of the fact that the range of application of this form of power transmission is practically **unlimited**. In many cases **Morse Chains** will give **Better Service** than any other form of drive for running **Pumps, Compressors, Electric Generators, Exciters, Fans, Etc.**

We now have in successful operation drives transmitting an aggregate of over 500,000 H. P. Individual drives running from 1 H. P. to 2000 H. P. each.

Let us figure on some of your power transmission problems.
 Our Bulletin No. 9B is particularly interesting.

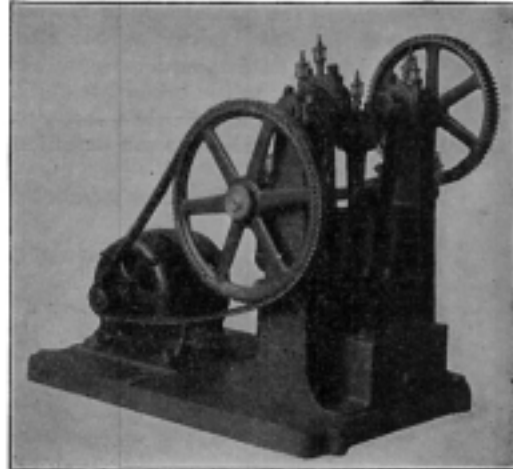
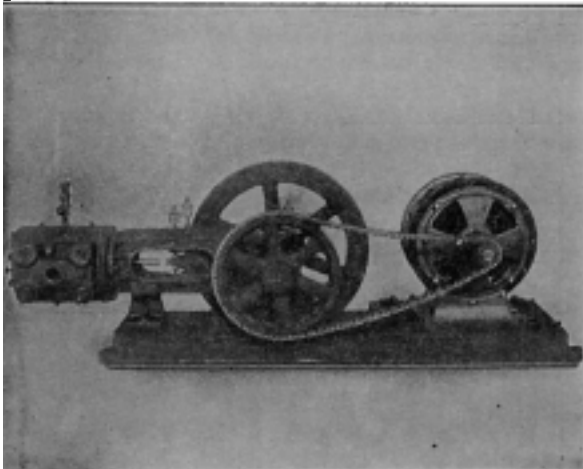

**MORSE CHAIN CO., Ithaca, N. Y.
 N. E. BRANCH, 141 MILK STREET, BOSTON**



A. W. BUHLMANN

Textile-Engineer

200 Fifth Avenue - New York

Representative in the United States and Canada
for

FRANZ MUELLER, Maschinenfabrik, M. Gladbach

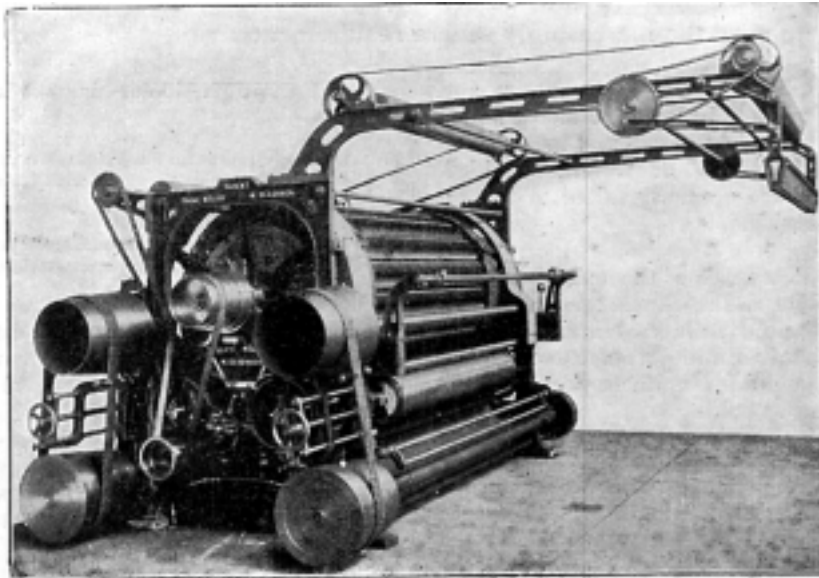

The Mueller 36 Roller Universal Napping Machine

- ¶ The Supremacy of the Mueller Napper is acknowledged all over the world.
- ¶ For years this machine has been used by the leading firms of the trade in preference to any other napper.
- ¶ No other machine can surpass it in point of construction, workmanship and economical upkeep. None can equal it in quality and quantity of production.
- ¶ It is the Napper you will eventually buy.



Progress Made in the Manufacture of Leather Belting

In the construction of leather belts in the early days of the industry, the whole hide was cut into strips which were riveted together, so that the one grade of belting produced was made from leather that varied in quality, thickness and weight. This belting for several years answered all purposes for which belting was used.

The development of modern efficient machinery necessitated the manufacture of higher grade belting to meet the increasingly severe requirements.

Careful study in workshop, testing room, and laboratory has resulted in the selection of hides, and the adaptation of processes and materials to produce several brands, or weights of high quality belting each peculiarly suited to certain conditions of service.

The rigid maintenance of this exact standard of quality, weight and thickness for each brand, in contrast to the old fashioned methods mentioned above, is of vital importance as it assures under similar conditions uniform service from any given brand of belting.

The improvement in leather for belting would have availed little had we not at the same time perfected a cement for joining laps, the use of which has superceded the old style weak riveted joint, and proven in actual service the strongest and most efficient method of constructing belts.

To determine the most efficient and economical quality, weight and thickness of leather

belting for any particular drive it is essential to know :—

- First :—Whether for a horizontal or vertical drive.
- Second :—Open drive, drive with idler, or quarter turn drive.
- Third :—Diameter of pulleys.
- Fourth :—Revolutions per minute of driving pulley.
- Fifth :—Horse power to be transmitted.

Oak Tanned Leather Belting, as it has been developed, is recognized as the best belting for ordinary conditions. For certain unusual and exacting demands, however, we make a belt—our SPARTAN BRAND—using specially tanned leather and special cement—a belt remarkable for its pliability and consequently increased pulley-grip, great tensile strength and resistance to steam, water, oil, heat and chemical fumes.

A comparison of the crude leather belting of early days with our remarkably efficient modern product will prove that our industry is well abreast of the day in mechanical progress.

Subject for next month: "Proper Selection of Belts"

The Graton & Knight Mfg. Co.

Oak Leather Tanners and Belt Makers
WORCESTER, MASS., U. S. A.

"Consult our Engineering Department in connection with your Transmission Problems."

MONFORTS

**Largest Napper Builder
in the World**

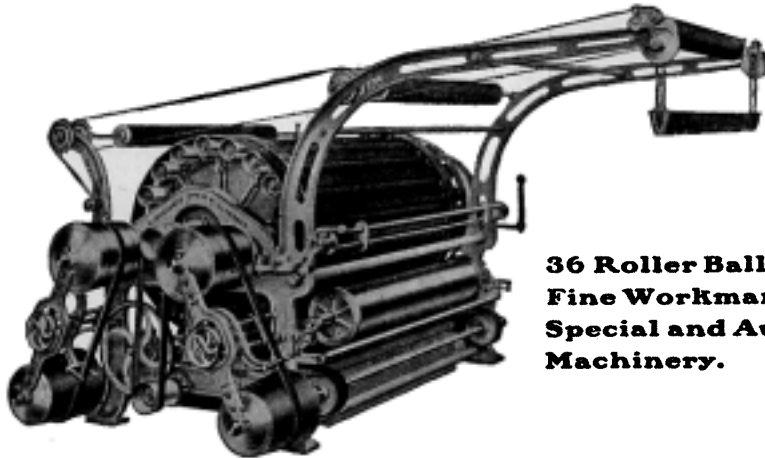

**36 Roller Ball Bearing
Fine Workmanship by
Special and Automatic
Machinery.**

TRY THE NEW TARIFF

ON OUR

Rotary Presses, Paul Klug Dry and Wet Decating, Fulling Machines, Tentering and Drying Machines with Automatic Electric Feeder, Cross Spool and Beam Dyeing. The new process Niederlahnstein Automatic Hank Mercerizing, Card and Napper Clothing, etc.

L. H. A. Schwartz & Co.

40 Central Street

Boston, Mass.

Cramer System of Air Conditioning



Cramer "High Duty" Air Conditioner

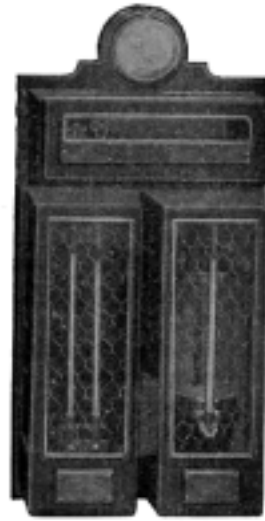

Cramer Automatic Regulator

FACTS

In several large mills equipped with humidifiers of other makes, we have entirely reorganized their system, installing our "High Duty" equipment with automatic humidity and temperature control and the average improvement during the succeeding twelve months test is:

- A—Seconds reduced over 50%.*
- B—Production uniform day after day (No big jumps.)*
- C—Actual waste account halved.*
- D—Large saving in "invisible waste."*

What Would Similar Results Be Worth To You?

STUART W. CRAMER

50 Church St.
New York

Charlotte, N. C.

Tremont Bldg.
Boston, Mass.

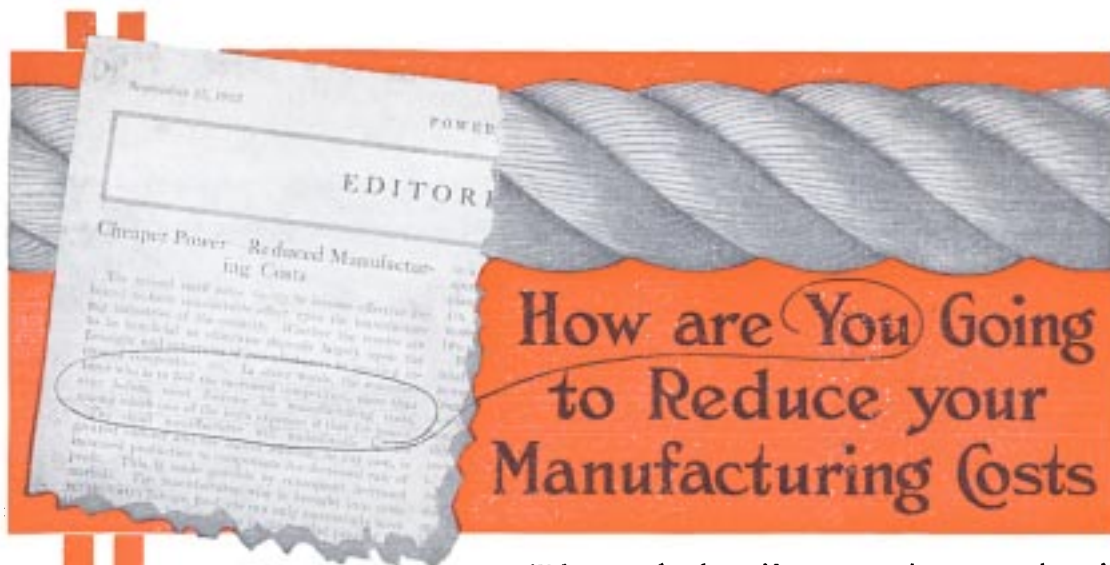

It will have to be done if you are going to continue in business. Power is one of your main items of expense. Get and use *all* the power your plant produces by installing the most efficient and economical system of power distribution. Eliminate all waste—change power losses into power profits. It is important under any manufacturing conditions—imperative under the new tariff conditions. Rope Driving properly installed—properly operated will contribute more largely and effectively towards manufacturing economy than any other mechanical readjustment you can adopt. *Because*—Rope Transmission saves power—applies it most efficiently—reduces power expense to rock bottom figures. Use

AMERICAN TRANSMISSION ROPE

and make these results sure.

Any plant where transmission rope is used can effect needful economies by putting in "American." It works best—wears best. Will not stretch. No power lost through slippage—no time lost through break-downs. In-doors or out-doors it gives perfect service. Will out-last any other make—reduce renewal charges.

Made of best selected Manila hemp only—through and through. Subjected to careful testing and inspection. Outer yarns edged to withstand wear. Core and inner yarns treated with a special lubricant to eliminate internal friction. This lubricant works throughout the whole rope protecting and waterproofing it.

MANUFACTURERS—study the power question closely. It's to your advantage. Your existence as a manufacturer depends upon intelligent action *now*.

A Valuable Book—Free

Let us have your name and address and it will give us pleasure to mail you **FREE** our "Blue Book of Rope Transmission." It may help you to solve your transmission problems. It treats the subject fully and contains much valuable information. Write for it to-day.

**We Ship Without Delay—on Telegram if Necessary
from either point of manufacture**

**American
Manufacturing Co.**
Dept. T
Brooklyn, New York City



**St. Louis
Cordage Mills**
Dept. T
St. Louis, Missouri



Stop Paying for Power You Do Not Use



Every textile mill using old fashioned plain bearing hangers for line shafting is wasting from 50% to 75% of their total power consumption.

Constant danger of dripping oil which results in "seconds" is another big loss which may be attributed to the use of old style hangers.

These two expensive features may be eliminated and many savings effected by the use of

S K F

Self-Aligning Ball Bearing Hangers

ROLLING SUBSTITUTED FOR RUBBING contact in the bearings means a minimum of friction and the operation of the shaft at the highest possible efficiency.

SELF-ALIGNMENT means the ability to compensate for shaft deflection or any inaccuracy of alignment, and is instantaneous and automatic in S K F Ball Bearings.

S K F BALL BEARING HANGERS require a minimum amount of lubricant at infrequent intervals. This means a big saving in time.

The hanger box is so constructed as to prevent absolutely any leakage of lubricant. This means a big saving in lubricant.

You've got to save power to make money nowadays.

Write for hanger Bulletin No. 10

S K F BALL BEARING CO.
50 CHURCH STREET, NEW YORK

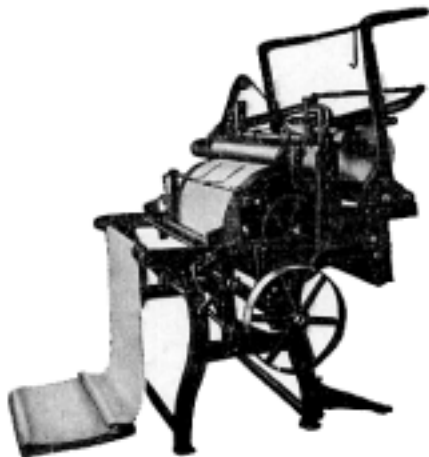

Parks
&
Woolson
Machine
Co
Springfield
Vermont

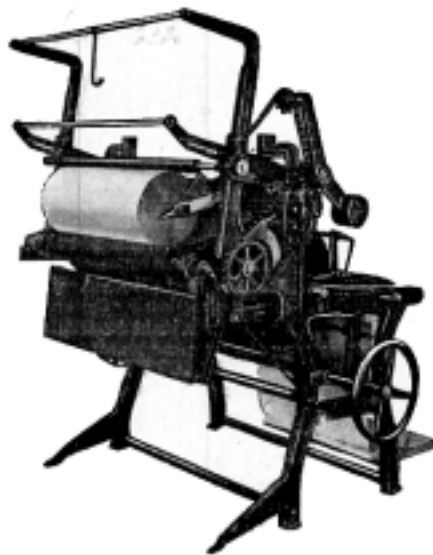

BOARDLESS PACKAGING

Measures all fabrics and rolls for market on any ROUND core from one-half inch diameter up. Core need not project outside cloth edges and may be withdrawn after rolling. Trade-marking included if wanted. Especially adapted for heavy plushes, chinchillas, velvets and all difficult textiles.

SMITH, DRUM & CO.

"BUILDERS OF THE BEST"

Labor Saving Machinery for Dyeing, Singeing and Finishing

HOSIERY

IN SULPHUR, ANILINE, DEVELOPED BLACKS AND COLORS
POWER SCREW PRESSES and MERCERIZING MACHINES

SAVE LABOR and DYE STUFF and do BETTER WORK

in your dye house by using

Smith, Drum & Co. Machines

Full Particulars on Application

Coral and
Cumberland Streets,
Philadelphia,
Pa.

Southern Agent
H. G. MAYER
Realty Bldg.,
CHARLOTTE, N. C.

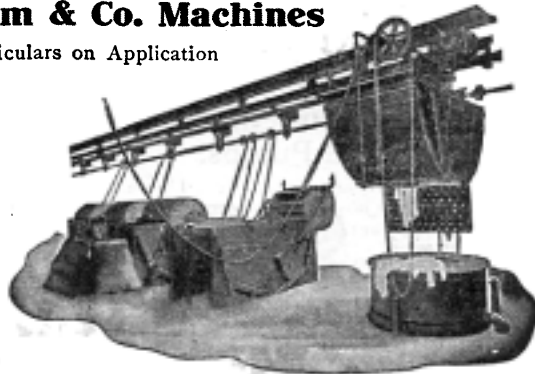

LAWSON'S

Hope Foundry, LEEDS, England

BRANCH OF

**Fairbairn Lawson Combe
Barbour, Ltd.**

MAKERS OF MACHINERY FOR

Preparing and Spinning

Flax, Hemp, Tow and Jute

Special Machinery

For the Manufacture of

Twines, Rope Yarns and Binder Twine

Good's Combined Hackling
and Spreading Machines.

Long Reach Screw-Gill Draw-
ing Frames. Chain-Gill Draw-
ing Frames with Apron Heads.

Patent High-Speed Horizontal
and Automatic Spinning
Frames for Manila.

Improved Laying Machines.

Haskell-Dawes Tubing
Twisters.

Brownell's Patent Twisting and
Laying Machines for Twine.

*N. B.—Complete Plans and Estimates for
Flax, Tow, Hemp and Jute Mills, Trawl
Twine Factories and Steam Ropeworks.*

Goulds Centrifugals Are Adapted for Every Pumping Service in the Textile Mill



These pumps are extremely simple in design; their first cost is low; and for a given capacity they require less floor space than any other type of pump.

Their large open water ways make them especially suitable for pumping size and similar substances.

Ask for bulletins which give complete details on Goulds Centrifugal Pumps.

THE GOULDS MFG. CO.

LARGEST MFR. OF PUMPS FOR EVERY SERVICE

62 WEST FALL STREET - - SENECA FALLS, N. Y.

Branches and Agencies in Principal Cities



Peerless V Silent Chain Drives

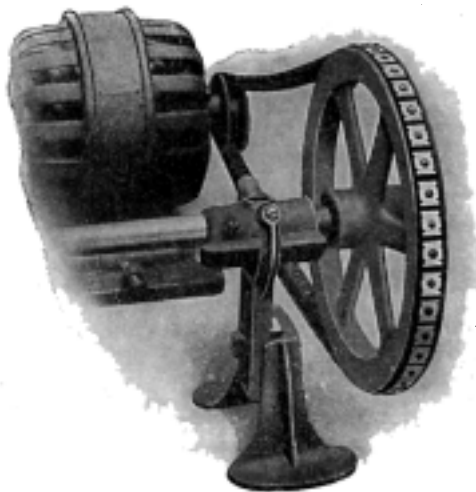

Sewing Machine Line Shaft with H. P. Peerless V Belt

Are absolutely noiseless in operation. Can be operated on very close centers. Are not in any way effected by moisture, dust, grit or lint. And owing to the principle of the wedge being fully utilized, slippage is avoided, making a positive drive.

If you are bothered with transmission troubles send for full information and let us solve them for you.

PEERLESS V BELT CO.

NEW YORK

CEDAR RAPIDS, IA.

CHICAGO

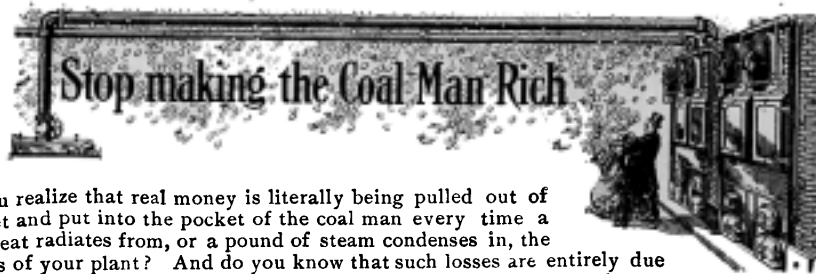

Do you realize that real money is literally being pulled out of your pocket and put into the pocket of the coal man every time a degree of heat radiates from, or a pound of steam condenses in, the steam pipes of your plant? And do you know that such losses are entirely due to the inefficient insulation afforded by ordinary pipe covering? Actual tests prove this to be so.

You can eliminate nearly all this loss because *actual tests prove* that over 75% of such losses can be prevented by the almost perfect insulating efficiency of

J-M Asbesto-Sponge Felted Pipe Covering

This covering is the most efficient insulator because it contains the greatest number of "dead air" cells. And "dead air," you know, is recognized by engineers everywhere as the most efficient insulator.

J-M Asbesto-Sponge Felted Pipe Covering is made of many layers of thin felt composed of pure Asbestos fibre and finely ground sponge. It is tough and flexible, so that vibration, moisture, heat or rough usage, will not cause it to break, crack, crumble, or lose its insulating efficiency. Absolutely fire-proof. Can be taken off and replaced without injury.

Write our nearest branch for sample, interesting test data and Catalog No. 100

H. W. JOHNS-MANVILLE CO.

Albany	Buffalo	Cleveland	Indianapolis	Louisville	New Orleans	Philadelphia	Seattle
Baltimore	Chicago	Dallas	Kansas City	Milwaukee	New York	Pittsburgh	St. Louis
Boston	Cincinnati	Detroit	Los Angeles	Minneapolis	Omaha	San Francisco	Syracuse

THE CANADIAN H. W. JOHNS-MANVILLE CO., LIMITED Toronto Montreal Winnipeg Vancouver 1811



Above All Others
as a protection for brick and cement
is the

Bay State Brick and Cement Coating

It does not destroy the distinctive texture of concrete and becomes a part of the material itself. It is specified and used by the largest architects, contractors and builders everywhere.

It is suitable for mill construction, private houses, hotels, bridges, or wherever concrete is exposed to moisture. It is endorsed by the National Board of Fire Underwriters as a fire retarder; comes in many shades.

Bay State Steel Coating

Protects as well as decorates iron and steel structures. A special rust preventative to be used under the finishing color to prevent the slow oxidizing action caused by moisture. Address for Color cards and new Booklets K of both Coatings, made and sold by

WADSWORTH, HOWLAND & CO., Inc.

Paint and Varnish Makers and Lead Corrodors

82-84 Washington Street - Boston, Mass.

New York Office, 101 Park Ave., at 40th St.



Truck ability proved in cross country runs

The Paramount Knitting Company of Waupun, Wisconsin, uses its 3-ton KesselKar Truck almost exclusively in cross-country work. The roads travelled are mostly unimproved and to cover the territory requires a sturdily constructed truck with a powerful motor.

The KesselKar Truck fulfills its mission in this case to the enthusiastic satisfaction of the Paramount Knitting Company. It is the same story with textile manufacturers and in kindred lines wherever wisdom has stepped in and dictated the selection of KesselKar Trucks.

KISSELKAR TRUCKS

SIX SIZES

1500 lbs., 1, 1½, 2½, 3½, 6 tons

There are four all important elements to be considered in the selection of a motor truck. 1st—the construction and *record* of the truck. 2nd—its adaptability to the duty required of it. 3rd—the permanency and responsibility of the makers. 4th—the facilities to give thorough service.

Investigate the KesselKar Truck and the written KesselKar Service Guarantee to owners. Write for illustrated portfolio.

Kissel Motor Car Company
528 Kissel Ave., Hartford, Wis.

New York, Minneapolis, Chicago, Philadelphia, Milwaukee, Los Angeles, San Francisco, Oakland, Dallas, Boston, St. Paul, Kansas City, and over 300 other leading points.

STEPHENSON

Bar Belt Dressing Prevents

Waste of Power and Fuel

Because it stops the belt from slipping and causes it to transmit all the Power without being made so tight as to cause unnecessary friction.

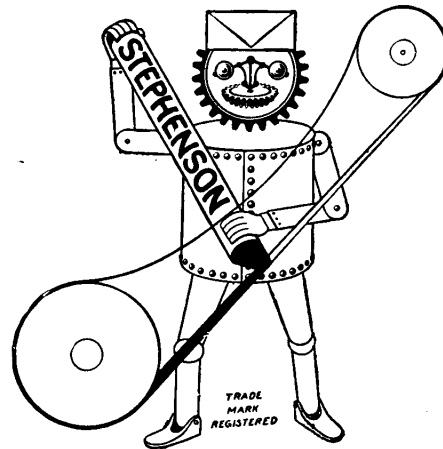

**This Registered Trademark
Is Your Protection**

It appears on each stick of Genuine Stephenson Bar Belt Dressing—the dressing that has held to its uniform quality for 23 years.

This belt dressing surpasses liquid preparations, for there is absolutely no waste in applying it to the belt, and it is put up in sticks or solid form, so that it can be carried about in the tool-box. For these reasons—

**1 Pound Lasts as Long as 2 Pounds of
Any Liquid or Semi-Liquid Dressing.**

There are two brands, Red Label for leather belts, Green Label for rubber, canvas, or balata belts.

Prices, literature and sample sent to any mill on request.

Stephenson Mfg. Co.

Main Office and Works,
Albany, N. Y.



Responsive Control An Advantage

Positive, non-vibratory construction is a cardinal feature of all Schaum & Uhlinger Hydro-Extractors. Of no less importance is their *responsive control*.

Tub after tub of materials can be separated in the shortest possible time with this machine, because it gets a quick start, soon attains full speed and is quickly brought to a stop by a powerful toggle brake. The

Schaum & Uhlinger Hydro-Extractor

is the choice of the men who are responsible for getting the work done and *done right*. The proof of its success lies in the fact that so many of these machines have been installed in plants all over the United States.

Send a postcard today for your free copy of "Centrifugal Extraction" — no obligation.

Schaum & Uhlinger, Inc.
204 Glenwood Avenue
Philadelphia, Pa.

THE STABILITY OF THE REVOLVATOR

SOME people think the Revolvator will tip over. It might look that way, but the Revolvator is so designed that any load that will balance upon the platform will not tip the machine over.

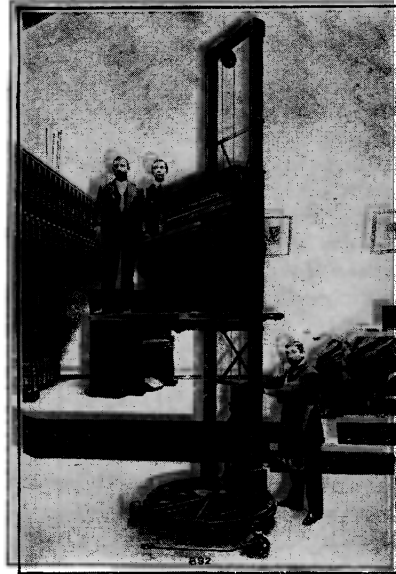

For instance, the Ft. Wayne Corrugated Paper Co. thought the machine would tip over. Here's what they wrote to us on January 11th:—

"Gentlemen:

We have your favor of the 2nd with reference to the new Revolving machine we purchased from you sometime ago. The machine is O. K., except that we have to be careful at times on account of tipping. We find that the machine will tip under certain conditions, otherwise it is O. K.

We wanted to find out more about under what conditions it would tip, so we asked them to give us a little further information. On the 16th of January they wrote us as follows:

"Since writing you I have taken the matter up myself and am well pleased to advise that the information given previously was erroneous. At any rate I was unable to discover any conditions whereby the elevator would tip.

"Our foreman in the shipping department simply thought it would, but after questioning him we found that it never did tip over."

Now we're willing to guarantee that the machine will not tip over if properly used. Have you any cases, bales, boxes, barrels, etc., in your plant that you want to compactly stow? Then ask us if the Revolvator will do it. Anyhow ask for a copy of our book W18, "Scientific Tying."

N. Y. Revolving Portable Elevator Co.
349 Garfield Avenue Jersey City, N. J.



More Space—Fewer Men—Less Damage

Don't these three factors have a big effect on storage costs?

More Space—because boxes, bales and goods of any kind can be piled clear to the ceiling in a systematic manner.

Fewer Men—because you eliminate the straining of four or five men necessary to raise a heavy case a few feet, and substitute one man and possibly a helper, easily placing the heaviest packages as high as necessary.

Less Damage—in reality, *none*—no more cracked corners or split sides on cases, no more torn or trampled bales. Box or bale is easily raised to level of row and pushed off the rollers on to the pile.

In Your Own Factory no investment can approach this machine in the proportionate saving it will make for you. Give up your old methods, displace five men with one or two, increase your storage capacity 50%, and cut handling costs in half.

Economy Engineering Company
413 S. Washtenaw Ave., Chicago, Ill.

You ought to know about the

**ECONOMY STEEL
TIERING MACHINE**

Write today for Booklet No. 16
It shows how some of our machines
look in actual service

THE GEB PATENT TENSION CONTROLLER

Patented Nov. 26, 1907; Dec. 20, 1910

For Apperly Feeds. Will Expand 1½ Inches

An Efficient Device for Changing Speed of Traveller Without Stopping Card or Apperly Feed

We take pleasure in calling the attention of woollen manufacturers and other users of diagonal or intermediate card feeds to the above attachment. The chief advantages are as follows:

1. NO MORE STOPPING CARD to adjust traveller speed.
2. NO MORE BOTHER, INCONVENIENCE AND DELAY in putting laggings of leather, yarn or twine on the traveller pulley or taking them off.
3. INCREASE OF PRODUCTION by reason of the cards running continuously. The tension on the drawing or sliver can be KEPT RIGHT and therefore the drawing will break seldom or never, and if it does break it will take much less time than heretofore to start and readjust speed.
4. BETTER WORK FROM CARDS. When the tension on drawing or sliver is wrong, a bad feed is the result and uneven yarn. With this attachment the tension can be kept just right.
5. REDUCTION IN WASTE. Wrong tension, causing breaking of sliver or bad feeds, makes waste. This is eliminated.

Practically without exception the manufacturers who have tried this device have unqualifiedly approved same. We have never seen such a unanimous lot of testimonials about a new thing. We believe that it meets a long-felt want and that it will soon be universally recognized as indispensable.

The attachment consists of an expanding pulley permitting a change of two inches in diameter by simply turning a hand wheel or nut without stopping feed, and of a specially constructed bracket which will fit easily on any intermediate feed and allows a change in the position of the pulley to take up slack in belt, (or the opposite), caused by change in diameter of pulley. All the parts are substantially made and the pulley is provided with a flange to keep belt from slipping off.

We solicit your order to equip your APPERLY feeds with this attachment. It will pay for itself many times over in a short time.

GEO. S. HARWOOD & SON, 53 State St., Boston, Mass.

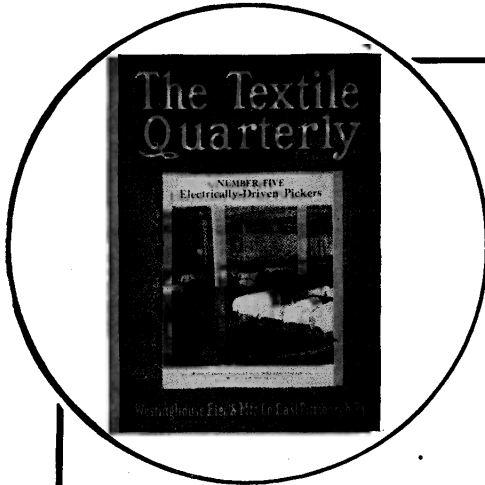

This Publication is of Vital Interest to Every Textile Man

Because it tells him how he can increase production without increasing costs.

It forms the best obtainable exposition of the motor drive of textile machinery—the reasons for installing motors, the various methods of drive, and the results obtained.

The following numbers have been published:

- | | |
|---|--------------------------------------|
| 1. Motor Drive in Cotton Spinning Mills | 4. Motor Drive in the Silk Industry |
| 2. Motor Drive for Worsted and Woolen Looms | 5. Electrically Driven Pickers |
| 3. Motor Drive in Knitting Mills | 6. The Illumination of Textile Mills |

SEND FOR THE NUMBERS THAT INTEREST YOU

Westinghouse Electric & Mfg. Co. EAST PITTSBURGH, PA.

Boston Office:
Safe Deposit & Trust Co.

Charlotte Office:
American Building

Sales Offices
in 45 American Cities

Member Society for Electrical Development

"Do it Electrically"

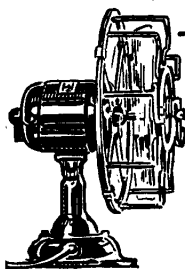

Do Your Pulleys Fan the Air?

If the blades of an electric fan were straightened so as to *cut* the air, the fan could be run at much less cost. Imagine the air resistance of fifty, one hundred or more pulleys, not constructed with special attention to air resistance. Calculate the *unnecessary* power cost. Eliminate needless expenditure by the installation of

"American" Steel Split Pulleys

The "American" Pulley "A" braced arms (edge on) give *least air resistance*, at the same time, perfect rigidity, trueness and strength. This is but *one* of the "American" power saving features.

Write for "Factors of Energy," a useful little book.

THE AMERICAN PULLEY COMPANY

OFFICE AND WORKS: PHILADELPHIA, PA.

Warehouses: New York, Grand Sts.; Boston, 105 Pearl St.; Chicago, 124 S. Clinton St.

DEALERS EVERYWHERE

Patented





LUNKENHEIMER NON-RETURN SAFETY BOILER STOP VALVES

In any steam plant where two or more boilers are installed in battery, the outlet from each boiler where same is connected to the header, should be provided with a **Lunkenheimer Non-Return Safety Boiler Stop Valve**.

Should the pressure in one of the boilers suddenly decrease, caused by an accident, a **Lunkenheimer Non-Return Safety Boiler Stop Valve** is guaranteed to close immediately and prevent the steam from the other boilers of the battery entering and discharging through the disabled one. Danger to life and property is greatly lessened, and as the plant can be operated with the other boiler, or boilers, without interference, considerable time and money are saved.

Chattering of the disc, caused by the fluctuation of the steam pressure is prevented by an ingenious outside spring arrangement.

Lunkenheimer Non-return Safety Boiler Stop Valves are exceptionally strong, durable and reliable. All parts subjected to wear are renewable. Made in five different combinations of material to suit the requirements of various conditions of superheat and high pressure, and to meet the specifications of engineers who may differ as to what is best suited to the purpose.

"MOST supply houses sell them--yours CAN--if they DONT or WONT--tell US"

Write for catalogue

THE LUNKENHEIMER COMPANY

Largest Manufacturers of High Grade Engineering Specialties in the World

General Offices and Works: CINCINNATI, OHIO, U.S.A.

New York,
64-68 Fulton St.

Chicago,
186 N. Dearborn St.

Boston,
138 High St.

London, S. E.
35 Great Dover St. 10-54

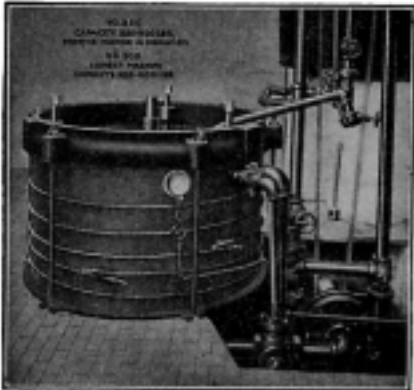

UP TO THE MINUTE

Wool and Worsted Top Dying

IN THE

PSARSKI DYEING MACHINE

PRACTICAL—ECONOMICAL—THOROUGH
UNIFORM COLOR

Dyes Wool and Tops—100 per cent. of Batch—absolutely level color throughout

NO FELTING

The Mass—Dormant White Dyeing—Cannot be Felted. Fibre comes out as Alive—Soft—Elastic and Spinable as it was Before Dyeing

DYES LOOSE WOOL

Acid Colors	2,000 pounds per day
Top Chromed Colors	1,500 " "
Bottom Chromed Colors	1,000 " "

DYES TOPS

Fine Wool	500 pounds per batch
Coarse Wool	800 " "

THREE BATCHES PER ELEVEN HOUR DAY

Tops are packed rapidly and easily. No special system or building. Tops are dyed uniform color throughout

NO FELTING—NO RE-COMBING—NO ADDITIONAL NOILS

SAVES 5 TO 10c PER POUND OVER OTHER MACHINES

SAVES 90 PER CENT. STEAM OVER HAND KETTLE OR REVOLVING MACHINES. SAVES DYES—LABOR—WATER
IS SIMPLE—STRONG—COMPACT—DURABLE—PRACTICALLY NEVER NEEDS REPAIRS

THE PSARSKI DYEING MACHINE COMPANY

3167 Fulton Road

::

::

::

::

CLEVELAND, OHIO

The Angle Steel Stool

ALL STEEL! (with Steel Seat) STEEL STOOL WITH SPRING STEEL BACK

Construction



No. 4

Legs—high carbon angle steel, $\frac{3}{4} \times \frac{3}{4} \times \frac{3}{4}$ in., making them very rigid and strong. Bottom of legs strong and smooth, allowing them to set level on the floor.

Joints—Riveted.

Stretchers—Flat steel, $\frac{3}{4}$ by $\frac{3}{16}$ inch.

Seat—Pressed Steel, highly finished enamel, 12 in. diameter.

This is Our Improved Modern Stool

Made with high carbon angle steel legs. It has a **13-inch hardwood seat**, mahogany stained, and the entire framework is nicely finished in dark green enamel. The backs are double braced and adjustable, with a simple motion they can be raised from 10 to 16 inches.

Frame construction same as No. 4.

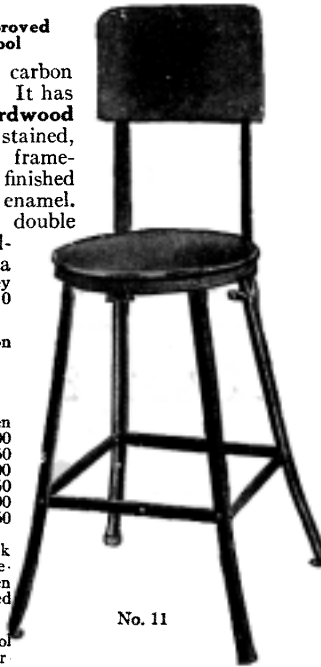

No. 11

Net Prices

Height	Per Dozen	Height	Per Dozen
20 inches	\$11.00	20 inches	\$16.00
22 inches	11.50	22 inches	16.50
24 inches	12.00	24 inches	17.00
26 inches	12.50	26 inches	17.50
28 inches	13.00	28 inches	18.00
30 inches	13.50	30 inches	18.50

No. 4 with back is our No. 44. Add \$4.00 per dozen to price quoted above.

We also make chairs and three legged stools.

WE MAKE STOOLS TO ANY HEIGHT YOU MAY DESIRE.

No. 11 without back is our No. 1. Deduct \$4.00 per dozen from price quoted above.

Do you need tool trucks, racks or merchandise conveyors?

Send for Catalogue No. 114.

Angle Steel Stool Co., Inc., Otsego, Mich.

"DOBBIES"

8 to 32 Harness

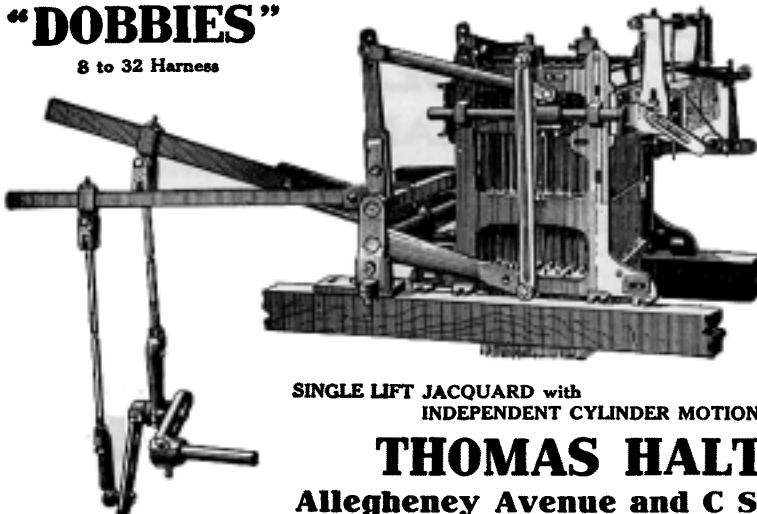

SINGLE LIFT JACQUARD with INDEPENDENT CYLINDER MOTION

"JACQUARDS"

208 to 2608 Hooks

ALL TYPES

HARNESS

BUILDING

THOMAS HALTON'S SONS

Allegheny Avenue and C Street, Philadelphia



Breton Oils

For wool are of definite and uniform quality. Over quarter of a century of hard work and constant attention to details has brought and keeps Breton Oils at the front. A grade for every requirement.

Sold subject to trial and approval.

BORNE, SCRMYSER & COMPANY, 80 South Street, New York
 Boston Fall River Philadelphia Works, Claremont, N. J.



WILLIAM BODDEN & SON, Limited

The **“BODDEN” Flyer**

**For QUALITY OF FINISH
 For QUANTITY of PRODUCTION
 HAS STOOD THE TEST OF YEARS**

Sole Agents for U. S. A.

Thomas Mayor & Son, Olney Street, Providence, R. I.



DIETZ “BLIZZARD” MILL LANTERN

(Approved by Insurance Inspection Department)

This lantern represents the highest type of WATCHMAN'S LANTERN on the market. Burns kerosene oil. Made in two sizes:

No. 1—13³/₄" High, 5/8" Wick, 6 Candle Power
 No. 2—14³/₄" High, 1" Wick, 10 " "

Holds sufficient oil to burn 10 hours

Locking attachment prevents your watchman tampering with flame
Dietz Mill Lanterns are for sale by all dealers in hardware and mill supplies



R. E. DIETZ COMPANY
Largest Makers of Lanterns in the World



GREENWICH AT LAIGHT STREET . . . NEW YORK CITY



The INTERNATIONAL

Distributes 15 cubic feet of **fresh air** per minute and from 1 to 4 gallons of water per hour as required.

**25 Per Cent
More Moisture than any
other Humidifier gives**

No return pipes to become clogged; no danger of damage by water; no attention required.
Costs no more than any other.
No cost for maintenance.

**International Moistening
Company**

Jackson Bldg. Providence, R. I.

“.....it showed no wear whatever”

C. MATTISON, President and Controller of Sells Bearings and Roller Bearings, Inc. and C. MATTISON, Secretary and Treasurer of Sells Bearings and Roller Bearings, Inc.

C. MATTISON MACHINE WORKS

**AUTOMATIC MACHINERY
FOR TURNING WOOD.
CUTTER HEADS & KNIVES.**



**BELT SANDERS
AUTOMATIC & HAND STROKE
FOR FLAT & IRREGULAR SURFACES**

BELOIT, WIS. Oct. 21, 1912.

Royersford Foundry & Machine Co., Inc.,
52 North 5th Street,
Philadelphia, Pa.,

Gentlemen:-

In reply to yours of the 19th, will say that we are pleased to report that your "Sells" Roller Bearings are giving perfect satisfaction.

We had occasion to move a Hanger the other day, and when the box was taken off it showed no wear whatever, and was in perfect condition. This box had been in continuous service for over a year.

Yours truly,

C. MATTISON MACHINE WORKS.

LETTERS like the one above from the Mattison people ought to convince any non-user of roller bearings of the genuine serviceability of SELLS Roller Bearings.

Evidence, you know, is always more convincing when it comes direct and the fact that

SELLS Roller Bearings

are so well advertised by the users themselves is pretty good reason why any doubter should at least investigate the proposition for himself.

We have first-hand testimony that SELLS BEARINGS have reduced the friction load from 25 to 50 per cent—big figures, to be sure, but *we can prove them.*

Will you put us to the test?

Royersford Foundry & Machine Co.
56 North Fifth Street
PHILADELPHIA



Power Transmission Machinery, Punching and Shearing Machines, Emery Grinders, and

“ROLLERINE”
the high grade lubricant

WILLIAM FIRTH

558-559 John Hancock Building,

200 Devonshire Street, Boston, Mass.

SOLE IMPORTER OF

ASA LEES & CO., Limited TEXTILE MACHINERY

OF EVERY DESCRIPTION FOR COTTON, WOOLEN AND WORSTED.

Sole Agents for

JOSEPH STUBBS, Gassing, Winding and Reeling Machinery
for Cotton, Worsted and Silk.

GEO. ORME & CO., Patent Hank Indicators, etc.

WILLIAM TATHAM & CO., Waste Machinery.
GOODBRAND & CO., Yarn Testing Machinery, Warp Reels.

BUCKLEY & CROSSLEY, Spindles, Flyer and Pressers, etc.

Also Agents for

JOSEPH SYKES BROS., Hardened and Tempered Steel Card Clothing for Cotton.

DRONSFIELD BROS. LTD., Emery Wheel Grinders, Emery Fillet and Flat Grinding Machines.

COTTON CORD AND VELVET CUTTING MACHINE CO., Corduroy Cutting Machines, etc.

Manufacturers of Warp Stop Motions - Dustless Card Strippers

BIRCH COTTON FINISHING MACHINERY

<p>Scutchers Angular Guides Conical Openers Stretchers Open Soapers</p>	<p>Washing Dyeing Squeezing Folders Rollers</p>	<p>Sewing Singeing Mangles Engines Napping</p>
---	---	--

THE BIRCH WOOLEN WORSTED FINISHING MACHINERY

<p>Crabbing Piece Dyeing Singeing Tentering</p>	<p>Steam Finishing Steam Blowing Sewing Tacking</p>	<p>Cloth Openers Folders Squeezing Napping</p>
---	---	--

BIRCH BROTHERS

ALBERT BIRCH, Textile Mechanician

SOMERVILLE MACHINE WORKS, SOMERVILLE, MASS.



RELIANCE

CLOTH HANGING MACHINE

For shrinking woolen, worsted and cotton goods; drying oilcloth, or waterproof cloth, and curing rubberized cloth.

Can be attached to any machine or operated separately

In use by the United States Quartermaster department for shrinking uniform cloth.

Write for catalogue and prices

Reliance Machine Works

Frankford, Phila.

WILLIAM FIRTH
Pres.

THE

FRANK B. COMINS
Vice-Pres. and Treas.

American Moistening Company

120 FRANKLIN STREET, BOSTON, MASS.

Received the HIGHEST AWARD on recommendation of the FRANKLIN INSTITUTE for

"SIMPLICITY AND ORIGINALITY OF DESIGN"

Is the largest manufacturer of HUMIDIFIERS in the world. The last twenty years receiving the HIGHEST AWARD in this country and Europe for its AIR-MOISTENING SYSTEM. EIGHT GOLD MEDALS and others.

The Only Perfect System of Air Moistening

Has Been Adopted by the Representative Manufacturers of this Country.

The only System adopted in the Textile Schools. Write for booklet "T" on Humidification. Legal proceedings will at once be taken against infringers and users of infringements.

JOHN HILL, Southern Representative, 510 Third National Bank Building, ATLANTA, GA.

Tolhurst Self Balancing Extractors

Belt, Engine and Motor Driven

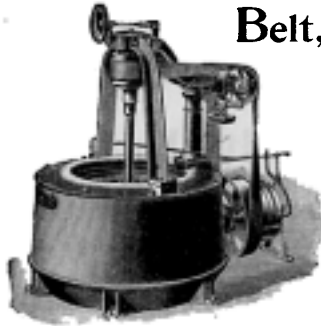

Over Driven Extractor

DYE TUBS AND
TANKS

*Reel Dyeing and
Bleaching Machines
Washing Machines*

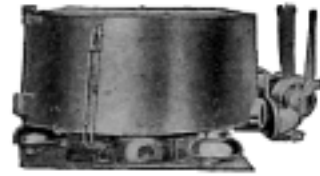

Open Top Extractor

TOLHURST MACHINE WORKS, Troy, N.Y.
FRED H. WHITE, Southern Agent, Realty Bldg., Charlotte, N.C.

INCREASE YOUR TENTER FRAME OUTPUT

With a Fan and Heater Coils

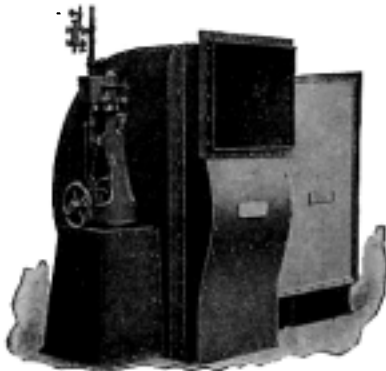

The Apparatus required is very simple.
The results decidedly increase the Output and Profits from each machine.

The New Tariff presents New Problems—
Maximum Economy is the best answer

Write us today for special information on this subject.

MASSACHUSETTS FAN CO.

400 Howard St.

Watertown, Mass.



WM. SELLERS & CO., INCORP'D

Main Office and Works

1600 Hamilton St., Philadelphia, Pa.

New England Office

79 Milk St., Boston, Mass.

Latest and most approved methods of

POWER TRANSMISSION by BELTS, ROPES, OR GEARS

Write for full information

SALEM ELEVATOR WORKS

Salem, Mass.

Elevators Especially Adapted for Textile Mills

Protect Yourself Against Liability Laws

We make a specialty of attaching to Elevators, already in use, Automatic Folding Hatch Doors, Semi and Full Automatic Gates, Automatic Locking and Stopping Devices, Automatic Car Safety Attachments, etc.

Send for Illustrated Catalogue and Estimate



The Murphy Automatic Smokeless Furnace

Burns Slack with Great Economy

The Murphy can be installed under any type of fire-tube or water-tube boiler and to units of any size.

SETTING UNDER TWO TYPES OF BOILERS SHOWN HEREWITH

MURPHY IRON WORKS

DETROIT, MICH.

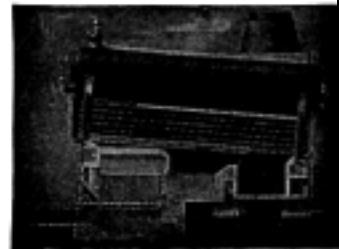

The Berry Wheel Is Cheaper Than The Fog

As a fog eliminator there is nothing to equal the **BERRY FAN**. It costs much less than the fog—for clearing up the atmosphere in your dye-house or mill means a better product and bigger profits. You can keep your production up to warm weather percentages by using a **BERRY**.

For Drying and Ventilating Facts, Write To
A. HUN BERRY, 29-33 West First St., Boston



This is the **BERRY WHEEL OR FAN** the most effective agent on the market for drying and for eliminating steam and other impurities in the air.

Hunt-McCormick and Francis Turbines

Penstock, Head Gate Apparatus

National Standard Type "B" Rotary Fire Pumps

TEXTILE MACHINERY

For finishing Woolens and Felts

Rodney Hunt Machine Company

Works and Main Office
Orange, Mass.

Boston Office
70 Kilby Street

ANOTHER ECONOMY Centrifugal Oil Separators

No. 1. Belt or Motor Drive. Pan capacity 520 cubic inches.
No. 2 (Cut). Pan capacity 2540 cubic inches. Adapted to bulky chips or turnings.
Time required to separate, from 5 to 8 minutes.

Save Oil and Pay if only **3** gallons per week are used.

The American Tool & Machine Co.
BOSTON

INCORPORATED 1864

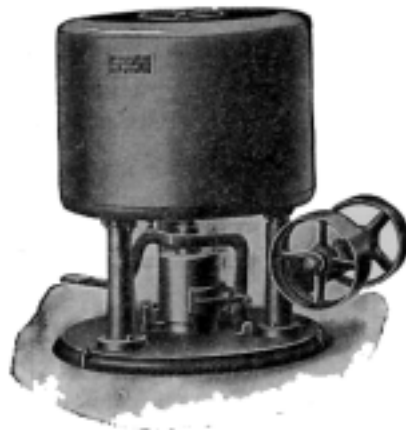

The Textile Industry of the United States leads the world in the production of low priced colored cotton fabrics of great merit and intrinsic value for the masses.

ONE of the chief contributing causes for the large increase in the production of colored cotton goods in the United States is the introduction of the "Fast Colors."

It was only a few years ago that consumers were afraid to buy colored cotton goods especially in light shades, such as Blue, Helio, etc., because the colors would not stand up under laundering and exposure to light.

Those who purchased colored cotton goods bought chiefly the dark shades in the hope that the fading would be gradual.

One of the advantages of colored cotton fabrics, besides being light and cool, is the feeling of cleanliness that comes from the fact that they can be laundered many times and without injury to appearance.

Many bought "White" when they would have preferred colored goods because they knew from sad experience that the colored effects were unsightly after a few launderings.

When Indanthrene dyed cotton goods began to appear on the market a few years ago the trade was naturally reluctant to believe that a really fast color for cotton had at last been found, but the consumers gradually saw the difference and began to realize that colored cotton goods were really worth while, since they could be produced in colors which would practically out-wear the fabric.

Gradually this feeling of confidence grew in the minds of consumers generally with the result that a large impetus was given to the colored cotton goods trade.

The end is not yet, but already

America leads in the use of Fast Colors; another reason why American goods merit the preference.

BADISCHE COMPANY

COPYRIGHT 1913. LORD & NAGLE COMPANY, REG. U. S. PAT. OFF.

TEXTILE WORLD RECORD

Published on the 12th of each month by

LORD & NAGLE COMPANY

FRANK L. NAGLE, President. HENRY G. LORD, Treasurer.

SAMUEL S. DALE, Editor.

Publication and Editorial Office

144 Congress Street, Boston

119 South Fourth Street, Philadelphia. 120 Liberty Street, New York.

537 South Dearborn Street, Chicago.

Entered at the Boston Post Office as Second Class Mail Matter.

Subscription Rates.

Textile World Record in the United States and Mexico	\$2.00 per year
To Canada, on account of extra postage	2.50 per year
To other Foreign Countries (postage paid)	3.00 per year
Textile World Record and the Official American Textile Directory (Traveler's Edition)	3.00 per year
To Foreign Countries with Directory (postage paid)	4.00 per year
Dyer's Supplement	1.00 per year

Remit by Express Order, Postal Money Order, Cheque or Registered Letter to Boston Office.

Advertising rates on application.

Official American Textile Directory

Published annually, in two editions. Office, Large Size, \$3.00. Travelers', Flexible, Smaller, \$2.00.

A Complete Directory of Cotton, Woolen, Knitting, Silk, Flax and Jute mills of the United States and Canada, together with the Dyeing and Finishing Works, Bleacheries, Print Works and other Textile Establishments; about 7,000 in all. Full information is given about each mill in almost every instance, viz., the name of the company or firm, names of officers, agent, superintendent, the character of goods made, the machinery equipment, i. e., the number of sets of cards (or combs), the number of spindles, number of looms; whether the mill uses steam or water power, whether there is a dye house or not, the names of the selling agents or if the mill sells direct. All this and much other information contained in this book is arranged in a way to be instantly accessible.

Vest Pocket Editions of the Directory are published in three sections, viz.: the New England States and Canada; Middle States; Southern and Western States. The price of these is \$1.00 per section.

American Directory of the Knitting Trade

Published annually in a handy size for the pocket, \$1.50.

It contains full reports of every knitting mill in the United States and Canada, giving capitalization, names of the officers, including superintendent and buyer; kind of goods made; number of knitting machines, whether latch or spring needle; number of sewing machines; whether the mill dyes or bleaches or finishes; kind of power; number employed; selling agent; kind of yarn bought; lists of the jobbers, manufacturers' selling agents, commission merchants, department stores and large retailers handling knit goods and the name of the person in charge of the knit goods department. List of dyers, bleachers, finishers, printers, etc., making a specialty of knit goods work. Special copyrighted maps of the mill districts, showing the cities and towns where there are knitting mills. It is indexed so any town or mill may be quickly found.

THE KNIT GOODS TRADE. The Dry Goods Section of the American Directory of the Knitting Trade is also bound separately. It is pocket size, has flexible covers, and contains classified lists of manufacturers, manufacturers' selling agents, jobbers, department stores, large Retailers, and New York Buyers. Price \$1.00.

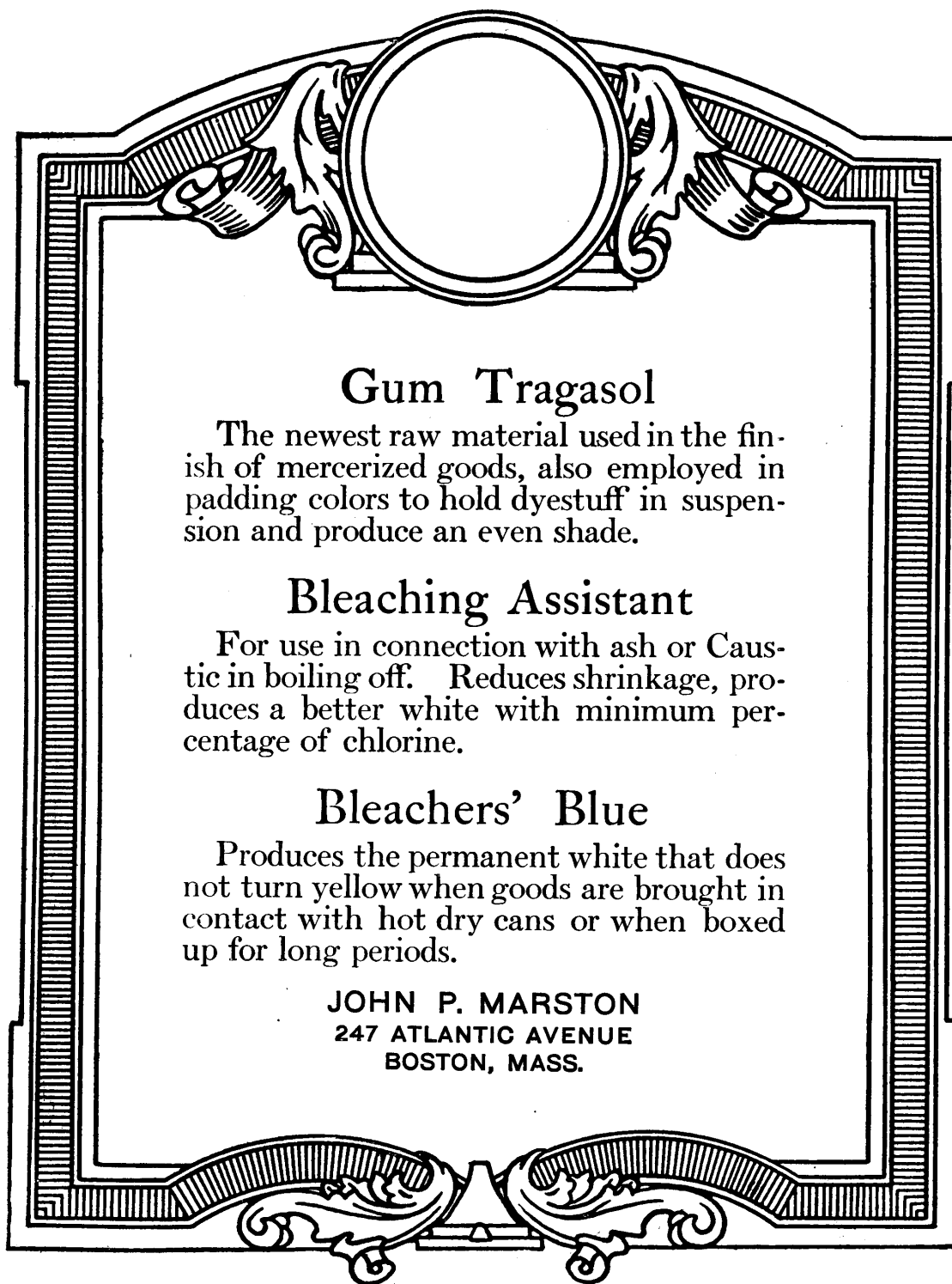

Gum Tragasol

The newest raw material used in the finish of mercerized goods, also employed in padding colors to hold dyestuff in suspension and produce an even shade.

Bleaching Assistant

For use in connection with ash or Caustic in boiling off. Reduces shrinkage, produces a better white with minimum percentage of chlorine.

Bleachers' Blue

Produces the permanent white that does not turn yellow when goods are brought in contact with hot dry cans or when boxed up for long periods.

JOHN P. MARSTON
247 ATLANTIC AVENUE
BOSTON, MASS.

Contents for December

	PAGE
Monthly Comment	53
The Southern Textile Association	63
The American Association of Woolen and Worsted Manufacturers	63
The Home Market Club	64
The American Cotton Manufacturers Association	64
The Artificial Ripening of Cotton	64
The Southern New England Textile Club	65
A Cotton Picker's Helper	65
Report of New Mill Construction for 1913	66
CORRESPONDENCE AND NOTES	81
Artificial Silk in the Form of Loose Fibers—Depression in the Scotch Tweed Industry—The Weaving of Filling Leno—A New Cotton Spinning Device—A New Process of Weaving Warp Pile Fabrics—A Hand Book of Weaves—English Notes—Moisture in Cotton Yarn—Caustic Soda in Sheep Dip—Setting and Removing Ring Travelers.	
QUESTIONS AND ANSWERS	99
KNITTING DEPARTMENT	106
The Knit Goods Situation—Seamless Hosiery—Fleecing Machines for Hosiery, Sweaters and Piece Goods—Knitted Sashes and Girdles—Plan of an Underwear Mill—Improvement in Hosiery Manufacture.	
DYEING, BLEACHING, FINISHING, ETC.	115
Back Filling Cotton Piece Goods—Agfa Soap—A Circulating Dyeing Machine—Bleaching Lace Curtains—The Dyeing of Wool Fabrics—Bleaching Cotton Goods—Dye Recipes.	
NEW MACHINERY AND PROCESSES.	124
PERSONALS	132
NEW PUBLICATIONS	135
BUSINESS LITERATURE	136
INDUSTRIAL NOTES	137
RECENT TEXTILE PATENTS	144
PUBLISHERS PAGE	160
MILL NEWS	169 to 223
WOOL MARKET	193
BRADFORD MARKET	195
COTTON MARKET	197
YARN MARKET	199
RAG AND SHODDY MARKET	209
SILK MARKET	211
DYESTUFFS AND CHEMICALS	217
MILL STOCKS	221

Correspondence

We solicit correspondence on textile subjects. Articles accepted will be paid for. Name and address must always be given, not necessarily for publication. Subscribers are invited to make free use of our Questions and Answers Department; correspondence is strictly confidential.

COTTON MACHINERY

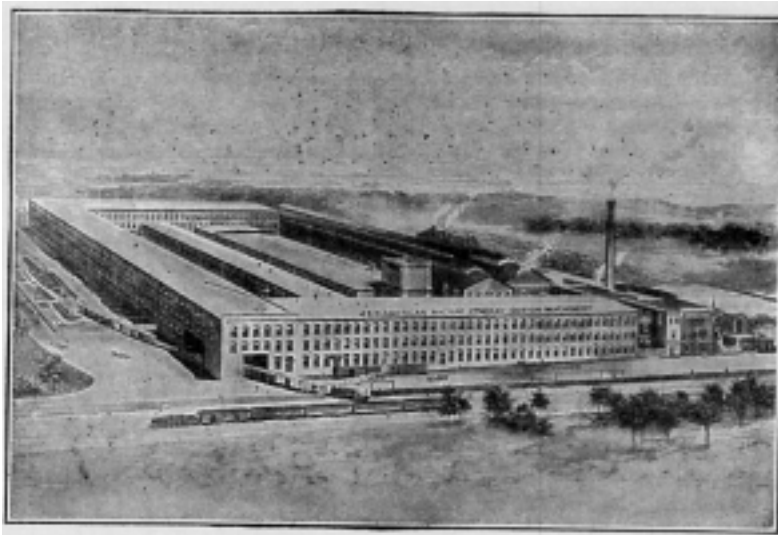

PICKING MACHINERY
REVOLVING FLAT CARDS
DRAWING FRAMES (WITH ELECTRIC OR MECHANICAL STOP MOTIONS)
SLUBBING, INTERMEDIATE ROVING AND JACK FRAMES
NEW PATTERN SPINNING FRAMES } WITH BAND OR TAPE DRIVE
IMPROVED TWISTERS
CONE WINDERS, WARPERS AND SLASHERS

H. & B. AMERICAN MACHINE COMPANY
PAWTUCKET, R. I.

BOSTON OFFICE
65 FRANKLIN ST.
C. E. RILEY, PREST.

ATLANTA OFFICE
814 EMPIRE BLDG.
E. CHAPPELL, So. REP.

TEXTILE WORLD RECORD

DECEMBER, 1913

Monthly Comment.

An American Merchandise Marks Act

Beginning with the Grosvenor "shoddy bill" of 1901, we have for twelve years left no opportunity unimproved to expose the absurdity of the bills that have been introduced in Congress to require the labling of textiles to show the materials of which they may be composed. These impracticable measures have been fathered by irresponsible men, ignorant of textile construction, too indolent or too much engrossed in cheap politics to study the subject, but desirous of gaining popularity by posing as the defenders of the consumers, who have the votes. While exposing these fake bills, of which the Grosvenor, Willis, Murdock and Lindquist bills are fair samples, we have steadily advocated the only practicable and efficient method of protecting the consumers against misrepresentation and fraud in the purchase, not only of textiles, but of all other commodities, that is, by legislation based on the principle of the British Merchandise Marks Act.

Our editorials on this subject beginning with January, 1902, have been sent to members of Congress at the time of their publication. No sound objection to our arguments has ever been advanced, and it is gratifying to learn that our campaign of education has not been in vain. Legislation of some kind on this subject now seems certain. A few weeks ago it was announced that President Wilson had held a conference with the leaders in Congress and that they had de-

ecided to support a bill more general in scope and aimed at fraud and misrepresentation on all lines of goods. Chairman Adamson of the House Committee on Interstate and Foreign Commerce has appointed a subcommittee at work framing the measure, and in announcing the legislative plans made this statement:

Bills have been introduced on different phases of this matter. Instead of popgun bills, we purpose to enact a general measure. It will be to some extent modeled after the British frauds act.

It is all very well for time serving politicians to introduce popgun "pure textile" bills in order to gain a cheap and passing popularity that may count on election day, but when men on whom rests the responsibility for enacting and executing laws, are called upon to act, they generally give heed to facts, reason and common sense. This is what will in all probability happen when an American Merchandise Marks Act is enacted, and it is gratifying to know that in following the course of reason and common sense those responsible for legislation must follow the advice of this magazine.

When a short time ago President Wilson signed a bill of which he seemed rather proud, he made a little speech in which he told how covetous he was of honor, quoting these lines of Henry V at the battle of Agincourt: "If it be a sin to covet honor, I am the most offending soul alive." This quotation by the President was not entirely apropos to the occasion, because the honor

that Henry V coveted was to win a victory against overwhelming odds, and the quotation was from a rebuke to an officer who wanted reinforcements. The President was taking the honor of an achievement won by the work of others, much of it done before he began his now three year old excursion into politics. If, as we hope, he is called upon to sign a bill modeled after the British Merchandise Marks Act, we trust he will re-read his Henry V and allow some of the honor of the achievement, if not the pen with which he signs the bill, to pass to the few who for many long years have opposed the overwhelming sentiment in favor of "pure textile" laws patterned after the pure food act, and have made the task of Congress and the President easy in 1914 by exposing the wrong principle of such legislation and pointing to that which is right.

The Hair of the Angora Goat

The fifteenth congressional district of Texas is located at the southernmost part of that great State on the V-shaped point that borders the Rio Grande on the west and the Gulf of Mexico on the east. The population is relatively small, only 252,906, but the area, 40,807 square miles, is of imperial dimensions. The district is two-thirds as large as New England, almost exactly the size of Ohio, one-third larger than Scotland and five times the size of Massachusetts. It is chiefly remarkable at the present time, however, by reason of its being represented in Congress by a stalwart and practical Democratic protectionist, the Hon. John Nance Garner, who, regardless of the mere wording of the national or local platform on which he runs for office, has the courage to stand firm for protection to American industry after he has obtained office.

During the recent revision of the tariff Congressman Garner was the enthusiastic and determined leader of an influential group of Democrats who stood for practical protection and succeeded in keeping a duty of 15 per cent. ad valorem on mohair despite the opposition of the Senate and the demand from the White House and State De-

partment for free wool. The Hon. Sereno E. Payne stated the case rather bluntly on April 28 in these words:

They raise some goats in the United States. There are 3,000,000 of them. They say that 2,999,999 of them are in Texas and Texas must have a duty on goat hair. Texas is quite a State, and has a good many Democratic Representatives.

With human nature as it is, the practical support of either free trade or protection is best developed by self-interest. The world's center of tariff free trade in Manchester, Eng., because the vast majority of ten million people living within a 50-mile radius of that city find it for their interest to have raw materials and foodstuffs free of duty in England, the English manufactures free of duty in other countries. The producers of cotton and woolen goods in Lancashire and Yorkshire favor free trade, and the producers of mohair in Texas favor protection from the same natural motive, that of self-interest, or rather, self-defense. And it is from the same motive that the great majority in England is for free trade; and in the United States for protection. Members of Parliament and Congress reflect the prevailing sentiment. That the Hon. John Nance Garner and his Democratic allies of Texas were the true representatives of the mohair producers of his State is shown by the resolutions adopted by the National Mohair Growers' Association at the annual meeting at Dallas, Tex., on October 31. After electing U. S. Grant, Dallas, Ore., president; A. B. Collins, Laguna, Tex., vice-president, and J. E. McCarty, Stephenville, Tex., secretary, the association passed a resolution thanking Congressman Garner for his work in securing a duty of 15 per cent. ad valorem on mohair, and pledging their support to him "in all his political aspirations." The Democratic protectionists of Texas, led by Congressman Garner, point the way for protectionists of all parties in every State. The Texans united in a demand for moderate and fairly adjusted protection to their industry, and they obtained what they demanded in spite of overwhelming odds against them. Protectionists in other States can do likewise when they will.

The Austrian Combine of Cotton Spinners

The combine formed some months ago by the cotton spinners of Austria to fix prices for their products has gained many new recruits. At the last meeting on Oct. 29 the membership represented an annual production of 194,000,000 pounds of yarn, as compared with a production of 135,000,000 pounds represented by the spinners who joined the combine at its organization. By a unanimous vote it was decided to continue the fixed price agreement in force until June 30, 1914. Plans were also approved for promoting the export of cotton yarn produced by members of the trust.

—:—

British Colonial Cotton

The meeting of the British Cotton Growing Association on Nov. 6 was in marked contrast to the meetings held by that organization in the first few years of its existence. The exuberent optimism and unyielding confidence of youth have disappeared and in their place we find a matter of fact statement of accomplishment and a businesslike caution in handling propositions for the development of cotton growing in untried fields. The purchases of cotton in Gagos for the nine months ending September amounted to 13,429 bales, a gratifying increase over the corresponding period of 1912 when only 3,968 bales were bought, and as compared with 11,762 bales in 1909. Northern Nigeria yielded 1,532 bales for the nine months of this year, as compared with 2,326 bales for the same period in 1912. The production of cotton in East Africa has become so large that the British East Africa Corporation is calling for \$225,000 of new capital to handle the crop. The total amount of British colonial cotton sold in September and October of this year was 18,689 bales valued at £241,000.

The new proposal for developing the growing of colonial cotton came from Australia in the form of an offer from the Queensland Government to guarantee a minimum price for cotton if the Association would undertake to establish the industry in that Commonwealth. Referring to this offer

J. A. Hutton, chairman of the Association, said:

I must, however, point out that the Committee do not think that a mere offer to guarantee a minimum price is sufficient, for before one would be justified in encouraging any farmer to spend money in growing cotton it is essential that certain experimental work should be carried out with various types of cotton and in different districts in order to prove which type of cotton is most suitable for each district and which are the best methods of cultivation, and also whether or not the cotton can be produced on a commercial basis—or, in other words, whether the farmer can make money out of it. It has been shown that cotton of good quality can be produced in Australia, and it is this question of whether it can be grown on a commercial basis which has to be ascertained. Only by actual experiment can this be done, and the experiments should be spread over a period of not less than three years.

Chairman Hutton then discussed the different types of cotton in connection with the Queensland proposal:

Only experience will enable one to decide definitely which type will be most suitable. I may, however, state at once that there are two types which should not be encouraged—viz., Sea Island and perennial cotton. The market for Sea Island cotton is a very small one, and is already very fully supplied from the United States and the West Indies. As to perennial types, they may do well enough on a small scale, but, speaking from experience spread all over the world, in the long run their cultivation is not a profitable one, and the type of cotton, though suitable for mixing with wool, is not suitable for cotton-spinning. There is also the great disadvantage that they give every facility for the spread of cotton pests and diseases.

The other remaining types are Indian, Egyptian and American. Indian cotton is short, of very low value, and can therefore be ruled out at once. Egyptian does well under irrigation, but is hardly to be recommended as a rain crop, but it might be worth while trying a few small experiments. As regards American, we should hardly recommend the shorter stapled varieties owing to their low value, though these are undoubtedly the easiest to grow, and are heavy croppers. There are, however, many high-class varieties of upland cotton, some of which are worth as much as good Egyptian cotton, as for example Allen's Improved, Sunflower, Griffin, etc., and, as far as we can judge, this type would probably be most suitable for the country, though this can only be decided after two or three years' careful experimental work.

After considering the question carefully the Committee of the Association made the following offer to the Queensland Government:

(a) The Association will do all in their power to assist, either by advice or otherwise, and they will

contribute the sum of £100 per annum towards the cost of these experiments for a period of three years, dating from July 1, 1914.

(b) The Association will supply, free of charge, small quantities of seed for experimental purposes.

(c) The Association will report from time to time on any samples of cotton.

(d) The Association will superintend the sale of any cotton or seed shipped to this country and will undertake to obtain the best possible price for such shipments.

(e) The Association will keep separate accounts for each shipper and will superintend the remittance of the proceeds of each lot of cotton or seed, and will pay the same to the account of the producer either in this country or in Australia.

(f) The Association will pay the ocean freight and will superintend the insurance of the cotton, and will, when required, arrange for it to be covered against all risks from the time it is weighed in from the fields up to the warehouse in Liverpool.

(g) The Association will, when required, make arrangements for financing cotton or seed by accepting bills drawn on shipment.

(h) The Association are prepared to supply ginning and other machinery, baling material, and other stores, on easy terms of repayment, and will give the buyer the full advantage of all cash and trade discounts.

(i) The Association will charge for the above services the following commission in addition to interest and other out of pocket charges: Cotton, 1 per cent. (including the broker's charges of 1/2 per cent.); seed, 1 1/2 per cent. (including the broker's charges of 1 per cent.); buildings, machinery, baling materials, etc., 2 per cent.

(j) For a period of three years, dating from July 1, 1914, the Association will guarantee a minimum price in Liverpool or London of 6 1/2d. per pound (less insurance, port, and other charges, which amount to about 1/2d. per pound) for all cotton forwarded to them for sale, and which shall have been produced from an annual variety grown from seed issued by the Government, and which shall be shipped in a clean and merchantable condition. Any surplus which may be obtained over the above-mentioned price of 6 1/2 d. per pound will be remitted to the planter. It is stipulated that this offer does not apply to any cotton grown from perennial varieties or from ratooned cotton.

Foreign Competition in Cotton Goods

That thick and thin supporter of the low tariff policy of the present administration, the "Providence Journal," recently made this sapient comment on the competition of foreign cotton mills under the new tariff law:

Whenever during the present year a cotton mill in this country has curtailed production by closing down, or running on short time, the action has been laid to the menacing influence of the Underwood tariff, and to the fear that the reduction of duties under it would let in a flood of foreign cottons. Naturally, if this were true, European mills, especially those of low-wage protective

countries, ought to be running on full or extra time, turning out goods for the American market. It appears, however, that in both low-wage, protective European countries and higher-wage, shorter labor-day, free-trade England, factories are running or are planning to run on short time.

The new tariff had been a law just forty-six days when the "Journal's" editorial appeared, and at that time it is safe to say only a very few foreign merchants had learned what the new American duties on cotton cloth were. Nevertheless the "Journal" assumes the possibility of European cotton mills running on full or extra time filling orders from the United States. The development of new markets is a slow process, requiring many months before appreciable results can be expected. The exploration of the American cotton goods market by foreign mills is not likely to prove an exception to this rule, but the process will certainly be expedited by any depression in the cotton goods trade abroad.

Blinded by its political and economic prejudice the "Journal" points to the depression in European cotton mills as proof that the Underwood tariff is now so low as to encourage dangerous foreign competition, ignoring the fact that this newly arrived depression abroad brings with it the conditions that develop the evils of an adequate tariff in the United States. So long as foreign mills are fully occupied by orders from markets outside of the United States, they are not likely to menace the American industry. When the foreign mills run short of orders, however, and are searching for an outlet for their goods, the United States will become, not only a legitimate market, but a dumping ground for foreign goods. In this view of the situation the mills in foreign countries may be considered one competitive unit; those in the United States, another unit. The foreign cotton mills represent approximately 110,000,000 spindles; the mills in this country, 30,000,000 spindles. If the depression in foreign mills, whose significance the "Journal" so completely misconstrues, should develop into a settled shrinkage of 10 per cent. in their output, that would mean 11,000,000 idle spindles, equal to 36 per cent. of the 30,000,000 spindles in the United States. The proportion is small

when based on the capacity of the foreign industry, but it is a very large part of the American industry which is protected by the Underwood tariff. Under such conditions goods are dumped on the new market to keep the 11,000,000 spindles busy. That is the industrial possibility which it is the part of wisdom to face. That is what makes it so necessary to prevent undervaluation and other kinds of fraud under the new law; and that is what may make it necessary to call on the leaders in Congress to keep their promise to correct any defects in the adjustment of rates that may develop in the administration of the law.

The Southern Cotton Corporation

In our comment last month on fostering the growing of cotton we referred to the plans of the Southern Cotton Corporation to secure as high a price for cotton as they can get, and stated on the authority of press dispatches that the Corporation had recently suffered a setback by the failure to obtain a license to do business in Arkansas. President George D. Wadley informs us that this report is incorrect, and that the Corporation is now at work in eight of the Southern States, including Arkansas. He sends us a copy of the correspondence between the insurance commissioner and attorney general of Arkansas regarding the press reports and the business of the Corporation. This correspondence is as follows:

Wm. L. Moose, Attorney General:

Dear Sir—Through the newspapers the statement has gone out that I, as auditor and insurance commissioner, have refused to issue a permit to the Southern States Cotton Corporation to do business in this state under the provisions of the act of March 28, 1913, commonly known as the "blue sky" law. In some instances it has been stated that permission has been revoked by me. These statements have probably grown out of the opinion rendered by you on the application of H. S. Mobley, president of the Farmers' Union.

Since your opinion addressed to Mr. Mobley concerning the contract of the Southern States Cotton Corporation I have received many inquiries about the matter. To all inquirers I have stated that I had not issued a permit, nor had permission been denied said corporation under the act of March 28, 1913.

No application has been made to this office by said corporation under the provisions of the act mentioned.

The records of the office of secretary of state show that the Southern States Cotton Corporation was incorporated under the laws of Alabama; that it complied with the incorporation laws of this state on November 1, 1912, and on that day the secretary of state issued his certificate reciting that fact. I am informed that it has been doing business in this state with an office in Little Rock and through agents in various portions of the state, contracting with the farmers.

In view of the many inquiries and as a matter of general information, I request your opinion as to whether the business proposed to be done as shown by said proposed contract and scrip "A" and "B," is in violation of the act of March 28, 1913. Copies of the contract and scrip are attached.

As the impression seems to have gone out in some quarters that a compliance by a corporation with the incorporation laws of the state releases it from the operations of the act of March 28, 1913, I request your opinion on that matter.

Yours truly,

(Signed) L. L. Coffman,
Auditor and Insurance Commissioner.

L. L. Coffman, State Auditor and Insurance Commissioner:

Dear Sir—I have received your letter of the 14th inst., enclosing blank printed copies of the contract of the Southern States Cotton Corporation, and what are termed Series A and B scrip issued by the said corporation in the purchase of cotton from farmers in this state. . . .

Provisions of Act

Sections 1 and 2 of the act provide in substance that every individual corporation, copartnership and company other than national banks or corporations not organized for profit, which shall sell or negotiate for the sale of any stocks, contracts, bonds or other securities, except bonds of the United States or some municipality, or notes secured by mortgages on real estate located in Arkansas, shall comply with the act by furnishing to the auditor and insurance commissioner certain information, under oath, concerning the individual or corporation who proposes to sell the securities, together with copies of the contracts, bonds, or other instruments which it proposes to make with or sell to its contributors.

You will observe that the act applies only to individuals or corporations who sell or negotiate for the sale of certain contracts, bonds or other securities. Its manifest purpose is to protect the citizen from investing in worthless stocks, bonds or other securities.

Judging by the copies of the contract and the scrip which the Southern States Cotton Corporation is issuing the said corporation is selling nothing, and proposes to sell nothing; but is endeavoring to purchase cotton only.

Without further elaboration, it is my opinion that the "Blue Sky Law" does not apply to this corporation, and that said corporation is under no obligation to comply with its requirements.

Very truly yours,

William L. Moose,
Attorney General.

The "Underwood" Gingham

The following telegrams, published in the Daily Trade Record of November 13, and which passed between F. B. Shipley, of F. B. Shipley & Co., importers of cotton goods at 49 Leonard St., New York, and Hon. Oscar W. Underwood, call attention to matters of special importance to the textile trade:

Hon. Oscar W. Underwood, Washington, D. C.

For many years I have sold a Scotch gingham which has retailed at 35 cents. The difference in cost under the Underwood bill because of the fixed stepping stones of retail prices now enable its retailing at 19 cents. I desire to name it Underwood gingham in your honor. Please telegraph if you consent.

F. B. Shipley.

F. B. Shipley, 49 Leonard St., N. Y.

Appreciate your desire to name gingham after me. Am glad to have you do so.

O. W. Underwood.

Mr. Shipley's telegram is open to but one construction, that the lowering of the duty on this gingham from the Payne to the Underwood rate has enabled him to reduce the price to the jobber so that under the present methods of doing business in this country the cloth can now be sold to the ultimate consumer at 19 cents a yard instead of 35 cents, the price under the Payne law. As this is certainly important if true, we have made an investigation to determine the facts. First we analyzed a sample of the goods with the following result:

"Underwood" gingham, 31 1/2 inches wide.
Boiled-off:

Grains per 1/300 sq. yd.	3.6
Threads, warp and filling, per inch ...	138
Average yarn number	38.3

The Underwood duty on this cloth is 15 per cent., regardless of the allowance for sizing, because the yarn number would call for the same rate even if all the sizing, 6 1/2 per cent., were included in the calculation. Under the Payne law the duty was 4 1/4 cents per square yard, or 3 3/4 cents per yard 31 1/2 inches wide. The Underwood duty, assuming a foreign value of 10 cents, is 1 1/2 cents per running yard. In other words, the duty on this fabric has been reduced 2 1/4 cents per yard, and, according to Mr. Shipley, this has made it possible to reduce the price to the consumer from 35 cents to 19 cents per yard.

Mr. Shipley's telegram is so worded as to connect the fixed stepping stones of retail prices with the tariff in bringing about this remarkable reduction in price. Under the fixed price system a change in the wholesale price may cause a disproportionate change in the price at retail, but no previous announcement has ever prepared the trade for the remarkable reduction in the price of the "Underwood" gingham from 35 to 19 cents as a result of a tariff reduction of 2 1/4 cents per yard.

When Mr. Shipley published the correspondence announcing the name and price of the "Underwood" gingham, he made the matter a proper subject for public criticism. Having said what he has to Mr. Underwood and the public, he should go farther and explain clearly by what legerdemain a saving of 2 1/4 cents to him is converted into a saving of 16 cents to the consumer. Not only protectionists, but Mr. Underwood himself, in whose honor the gingham has been named, have the right to expect that Mr. Shipley will clear up the doubt with which our figures surround the "Underwood" gingham.

—:—

Revision of Differences by New York Cotton Exchange

On Nov. 20, a committee of fourteen members of the New York Cotton Exchange held a meeting lasting three and a half hours for the purpose of fixing the differences on and off middling cotton by which deliveries and settlements of contracts are to be made under the rules of the Exchange until another revision is made. During the three and a half hours' conference a crowd of brokers packed the anteroom waiting eagerly for the words to come from the committee room that would fix the basis of prices for cotton for at least three months to come. When the door finally opened and the committee marched out the waiting brokers made a mad rush for the figures and then dashed for the telephones, telegraph and cable offices to notify the cotton trade at home and abroad. The previous revision was made on Feb. 5, 1913, the committee having decided in September to continue the

February differences in force. The next revision can be made in February, 1914. On Nov. 20 the committee increased both premiums and discounts, the following table showing (in cents) the new differences, compared with the old:

Fair	1.75 on	1.50 on
Strict middling fair	1.50 on	1.30 on
Middling fair	1.30 on	1.10 on
Strict good middling	.90 on	.68 on
Fully good middling	.78 on	.57 on
Good middling	.65 on	.46 on
Barely good middling	.48 on	.35 on
Strict middling	.32 on	.24 on
Full middling	.16 on	.12 on
Middling	—Basis—	
Barely middling	.25 off	.17 off
Strict low middling	.50 off	.35 off
Fully low middling	.85 off	.55 off
Low middling	1.25 off	.80 off
Strict good ordinary	2.00 off	1.40 off
Good ordinary	3.00 off	2.15 off
Strict good middling tinged	.45 on	.35 on
Good middling tinged	—Value of mid.—	
Strict middling tinged	.20 off	.15 off
Middling tinged	.40 off	.30 off
Strict low middling tinged	1.25 off	.85 off
Low middling tinged	3.00 off	2.00 off
Middling stained	1.25 off	.90 off

The following members of the committee were present at the November revision, two members, Edward H. Inman, of Atlanta, Ga., and Hugh M. Neely, Jr., of Memphis, Tenn., being absent: Henry Hentz, W. H. Hubbard, Edward P. Walker, Wm. Ray, M. P. Parrott, Luitpold Mandelbaum, Samuel Hopkins, J. Temple Gwathmey, Jr., P. S. Coate, Charles N. Brush of Boston, Moses C. Heath of Columbia, S. C., Frank H. Barrett of Augusta, Ga., A. Carl Espy of Savannah, Ga., and James E. Latham of Greensboro, N. C.

This revision of differences by the New York Cotton Exchange, coming at a time when a committee of the Exchange is considering plans for reforming its methods in order to meet the threatened legislation at Washington, serves to direct increased attention to the question of regulating cotton exchanges by law. In 1908 the Commissioner of Corporations, Herbert Knox Smith made a report on cotton exchanges after a careful investigation of the subject. He paid special attention to the question of "differences," the following being extracts from his conclusions. Since that report was issued the New

York Exchange has adopted the practice of revising the differences in February, September and November:

The rules of the New York Cotton Exchange provide no standard by which the revision committee shall act in fixing differences. On account of the narrowness of the New York spot market, the committee cannot revise differences purely on the basis of local transactions. It is not, however, compelled by any rule to fix them in accordance with the commercial differences prevailing at the time in the leading spot markets. The revision committee is, of course, supposed to take account of these commercial differences, but it is bound by no rules whatever.

It is obvious that the differences established by the New York revision committee may, and indeed at times must, be out of line with the actual relative values of the several grades of cotton in spot markets.

These disparities between the differences established by the New York revision committee and the actual commercial differences are bound to result in injury to certain classes of dealers in future contracts.

It is clearly incumbent upon the New York Cotton Exchange to readopt the commercial-difference principle, at least in its broad outlines. Whether the commercial-difference system in its entirety, as employed in New Orleans, should be adopted by the New York Cotton Exchange, or whether some modification of that system should be permitted is, however, an open question. A rigid application of the commercial-difference system would demand that contract difference be changed whenever a change occurred in commercial differences, and, moreover, that they be based upon spot quotations in the delivery market itself. Owing to the narrowness of the New York spot market, it is impracticable thus to use the New York quotations as a basis for establishing contract differences; consequently, New York must base its revisions in the main on the differences prevailing in leading southern markets.

The effect of a difference system upon the business of the New York market alone is not a proper basis for framing the rules of an exchange. The first consideration is that these rules shall be equitable and commercial. If the New York Cotton Exchange cannot exist under such rules, then it has no right to exist at all.

A few weeks ago the Mandelbaum Committee of the New York Cotton Exchange made a report in which the following changes in the rules of the exchange are proposed:

The adoption of the government standard grades, adding one lower grade.

Monthly revision of grade differences in spot cotton quotations, instead of three revisions a year.

Prohibition of the giving of credit for speculative purposes.

Elimination of good ordinary, low middling tinged, strict middling fair and fair cotton, in harmony with the Government standards.

Reduction in tare from 28 to 25 pounds per bale.

The members of the Exchange have these changes under consideration as this issue appears. It is not likely, however, that their adoption will stop the agitation in Congress to secure legislation regulating the cotton exchanges of the country.

The Census of Cotton Manufactures

Five years ago the government took a census throughout the United States and last month, nearly five years after the event, the textile trade was reminded of it by the unexpected appearance of the census bulletin relating to cotton manufactures. The age of the statistics is shown by the date, 1909, while the changes during that period are indicated by the total number of spindles, 27,425,608, for that year, and the number, 31,505,000, which the Census Bureau reported to the International Cotton Federation on Aug. 31, 1913. Although the spindles have increased 4,109,200, or 13 per cent., the 1909 figures have a value that even now is not entirely historical.

The census is summarized as follows:

	1909	1904
Establishments	1,324	1,154
Employees, wage and salaried	387,771	323,287
Horse power	1,296,517	986,604
Capital	\$822,238,000	\$613,111,000
Salaries	14,412,000	10,238,000
Wages	132,859,000	96,206,000
Materials, fuel and power	371,009,000	286,255,000
Products	628,392,000	450,468,000

The total cost as reported for 1909 is apportioned as follows:

Salaries	\$14,411,758	2.6%
Wages	132,859,145	24.4
Fuel and power	13,985,896	2.6
Materials	357,023,574	65.4
Miscellaneous	27,587,754	5.0
	<u>\$545,868,127</u>	<u>100%</u>

The size of the establishments in the cotton industry are indicated by the following classification:

Products per estab.	1909		1904	
	No.	%	No.	%
\$1,000,000 and over	163	12.3	99	8.6
\$100,000 to \$1,000,000	708	60.3	709	61.4
\$20,000 to \$100,000	280	21.1	273	23.7
\$5,000 to \$20,000	66	5.0	47	4.1
Less than \$5,000	17	1.3	26	2.3

1,324 100 1,154 100

The character of the products in 1909 is thus stated:

Plain cloth for converting	\$111,123,604
Sheetings and shirtings	88,890,888
Fancy	47,650,030
Duck	27,590,089
Cottonades	3,411,736
Upholstery goods	16,095,827
Towels and toweling	6,066,449
Tapes and webbing	5,559,099
Thread	20,650,616
Yarn for sale	109,400,376
All other	186,488,329
	<u>\$622,927,043</u>

The operatives in 1909 are thus classified according to ages and occupation:

	16 years and over	Under 16 years
Spinners	50,499	16,879
Weavers	99,107	3,306
Other	197,871	20,036
Total	<u>347,477</u>	<u>40,221</u>

The prevailing hours of labor per week and number of operatives are given in the following table:

48 hours and under	304
Between 48 and 54	2,879
54 hours	571
Between 54 and 60	190,998
60 hours	119,226
Between 60 and 72	64,687
72 hours and over	215
	<u>378,880</u>

The number of spindles and consumption of cotton are given by States as follows:

	Spindles	Bales
Alabama	885,803	241,073
Connecticut	1,241,524	117,189
Georgia	1,749,483	529,726
Maine	1,020,688	160,550
Maryland	133,302	57,358
Massachusetts	9,375,004	1,244,614
Mississippi	153,804	34,202
New Hampshire	1,318,932	285,659
New Jersey	420,784	34,354
New York	778,036	141,003
North Carolina	2,908,383	754,483
Pennsylvania	252,671	50,691
Rhode Island	2,363,689	223,670
South Carolina	3,754,251	694,834
Tennessee	225,638	58,574
Texas	97,628	32,686
Virginia	316,970	78,017
All other States	429,018	94,053
	<u>27,425,608</u>	<u>4,828,736</u>

The ownership of the cotton establishments are thus classified:

Individual	110
Firm	101
Corporation	1,113

1,324

Dobby and Jacquard

In the administration of the cotton schedule the Treasury Department has run up against the question: What is the difference between a jacquard and a doobby weave? Paragraph 258 of the new cotton schedule is as follows:

Curtains, table covers, and all articles manufactured of cotton chenille, or of which cotton chenille is the component material of chief value, tapestries, and other Jacquard figured upholstery goods, composed wholly or in chief value of cotton or other vegetable fiber; any of the foregoing, in the piece or otherwise, 35 per centum ad valorem; all other Jacquard figured manufactures of cotton or of which cotton is the component material of chief value, 30 per centum ad valorem.

If a cotton cloth is not classed under this paragraph 258 and subject to a duty of 35 or 30 per cent., it comes under paragraph 252 which provides for duties based on the average yarn number and varying from 7 1/2 per cent. to 30 per cent. The definition of the term "jacquard" is, consequently, a matter of much importance. In order to fortify the government against claims for the repayment of duties that may be collected under paragraph 258 the Treasury Department has authorized Appraiser F. A. Higgins of New York to send the following letter of inquiry to textile manufacturers in different parts of the country:

This office is desirous of obtaining your opinion on the subjects embraced in the following questions, and will appreciate an early reply:

1. If it were decided to produce in your mill a figured cotton cloth, how would you proceed to determine whether doobby or jacquard loom could be used—disregarding what you may determine from a mere viewing of the sample?

2. What is the greatest number of shafts ordinarily actuated by a doobby?

3. What is the maximum doobby capacity?

4. Would you consider, from a competitive point of view, that it would be untenable for this office to return for duty as cotton cloth figured (doobby) a figured cotton cloth produced by a jacquard, but capable of being ordinarily woven by a doobby?

5. In your judgment should it be controlling that all figured cotton cloth produced by 24 or less harnesses be returned for duty as doobby figured (cotton cloth figured, according to average count) even if jacquard figured, considering the provision for jacquard figured manufactures of cotton in paragraph 258?

The Philippine Islands imports of cotton goods during 1913 from the United States amounted to \$6,827,082, or 59 per cent. of the total, which amounted to \$11,583,638.

Standard Regain for Cotton

In our October issue we gave a table showing the actual moisture regain for worsted at Bradford and Boston for each month of the year 1912. The figures were based on the weather bureau's record at each place and on Hartshorne's tables of worsted regain. This month we give the statistics of moisture regain for cotton, based on the same weather observations and regain tables. Hartshorne's tables give no figures for cotton regain at temperatures below 40° F. This has made it necessary to omit the figures for the days on which the thermometer dropped below 40°, which was more frequently the case at Boston than at Bradford:

Highest, Lowest and Average Regain for Cotton at Boston and Bradford for Each Month of 1912.

BOSTON			
	Low	High	Av.
January	12.6	13.0	12.8
February	8.7	12.8	10.1
March	6.4	13.6	10.1
April	6.0	14.2	10.1
May	4.8	14.2	9.2
June	5.6	12.4	7.6
July	5.7	12.4	8.6
August	7.0	13.1	9.5
September	7.4	12.9	10.1
October	5.8	14.1	9.4
November	7.2	13.1	9.6
December	7.3	13.7	10.7
12 months	4.8	14.2	9.8

BRADFORD			
	Low	High	Av.
January	11.2	13.8	12.7
February	9.9	13.8	13.8
March	9.7	13.6	11.8
April	7.4	13.9	11.6
May	7.4	13.6	11.9
June	8.2	13.6	11.3
July	8.1	13.9	11.1
August	8.7	13.9	11.3
September	9.3	13.2	11.4
October	9.2	13.8	11.8
November	9.6	13.1	11.8
December	10.1	13.6	11.7
12 months	7.4	13.9	11.8

The recognized standard for moisture regain in cotton is 8 1/2 per cent. In only two months, April and May, did the actual regain fall below the 8 1/2 per cent. standard at Bradford, while the monthly average at Bradford exhibits great uniformity, the lowest average, 11.1 per cent., being found in June.

The variable weather at Boston, on the other hand, is indicated by the wide fluctuations in the monthly minimum, maximum and average. Ten of the twelve months at Boston show the regain below the 8 1/2 per cent. standard. The maximum record at Boston is fairly uniform, while the average fluctuates widely, dropping below the standard to 7.6 per cent. in June.

The Bradford average for the year, 11.8 per cent., is 2 per cent. above the Boston average of 9.8 per cent. It is generally admitted that a standard regain for conditioning should correspond as closely as possible to the actual regain. On that basis the Boston record for 1912 fails to supply any reason for adopting an American standard below 8 1/2 per cent.

These comparative records of moisture regain for cotton are of special interest at the present time when the Treasury Department is preparing to adopt a system of conditioning cotton yarn and cloth for the administration of the Underwood tariff. The only standard of cotton regain recognized by the cotton trade in this country and abroad is 8 1/2 per cent. The monthly average of actual regain at Boston during the year 1912 rose to 12.8 per cent. in January, and dropped below 8.6 per cent. for only one month, June, when it was 7.6 per cent., the average for the entire year being 9.8 per cent. This record of observations by the U. S. Weather Bureau shows that the established standard of 8 1/2 per cent. should remain unchanged, being much closer to the actual cotton regain in the United States than in England.

Notwithstanding these conditions, which can easily be determined, the Treasury officials on the recommendation of the Bureau of Standards have given a quasi-approval to an allowance of 7 per cent. for moisture in cotton cloth. Soon after the signing of the Underwood bill on October 3, M. J. Corbett & Co., custom house brokers and forwarding agents, 24 State St., New York, issued an elaborate set of tables for determining the average yarn number of cotton cloth. These tables were compiled and copyrighted by J. L. Hollings, of the U. S. Appraiser's Department, New York, who, it is stated, was one of the experts employed by the Finance Committee in framing the cot-

ton schedule. The Corbett-Hollings tables, which must have been compiled before the bill was signed, bore this introductory explanation:

Whenever the weight found is within 4 per cent. of its given equivalent weight in the table, it will be necessary to make further trials of at least four samples, and if the average weight is again found to be within 4 per cent., the sample must be conditioned, i. e., dried to bone dryness and regain added back.

About three weeks after these tables were published, Assistant Secretary of the Treasury Hamlin issued Treasury Decision 33823, which recommended the "straight line" method of calculating the average number in cotton cloth. The Corbett-Hollings tables were annexed to the decision, but with the introductory explanation regarding conditioning changed to the following.

Whenever the weight found is within 4 per cent. of its given equivalent weight in the table, it will be necessary to make further trials of at least four samples; and if the average weight is again found to be within 4 per cent., the sample must be conditioned, i. e., dried to bone dryness and a regain of 7 per cent. added back.

A decision by the Assistant Secretary of the Treasury is not law, but simply a regulation that is subject to a reversal by the courts. The explanatory note as to conditioning is not incorporated in the decision as signed by the Secretary of the Treasury, but is annexed to it. Last month we exposed the absurdity of the Hollings-Corbett limit of 4 per cent., which under certain conditions would cause the duty on one cloth to be lower than on another, although the average yarn number was higher. The 7 per cent. allowance for cotton regain as given in the Treasury edition of the Corbett-Hollings tables is no less unjustifiable. It would change the tariff from the rate intended. If the Treasury Department can arbitrarily reduce the allowance for moisture from 8 1/2 to 7 per cent., it can also increase the allowance or abolish it altogether, thus changing at will the tariff on cotton cloths. The apparent approval given to the 7 per cent. allowance should be withdrawn and the cotton cloth tariff administered as intended on the basis of the average yarn number indicating the number of 840-yard lengths in one pound with an allowance of 8 1/2 per cent. for moisture.

THE SOUTHERN TEXTILE ASSOCIATION

The semi-annual meeting of the Southern Textile Association was held at Atlanta, Ga., on November 21. President T. B. Wallace introduced Lee Jordan of the Atlanta Chamber of Commerce, who delivered an address of welcome, the response being made by A. D. Lowne, superintendent of the Fulton Bag and Cotton Mills of Atlanta. The president then delivered his formal address, which was followed by the reading of the following papers: Testing Testing, by N. A. Cobb, Washington, D. C.; Fuel Engineering, by W. T. Ray, of Spartanburg, S. C.

The session on November 22 was devoted to the business affairs of the association. It was decided to hold the spring meeting at the Isle of Palms. A large attendance was present at the banquet in the evening, at which Joseph H. Bradley of Huntsville, Ala., presided. Among those who made addresses were W. C. Dowd, president of the Textile Publishing Co., Charlotte, N. C.; Col. Sam Wilkes, Atlanta, Ga.; J. A. Greer, Griffin, Ga.; W. P. Hamrick, Columbia, S. C.

THE AMERICAN ASSOCIATION OF WOOLEN AND WORSTED MANUFACTURERS

The seventh annual meeting of this organization was held at Delmonico's on December 2, over one hundred members being present. In his address President Strong called attention to the good work being done by the association in preventing trade abuses. In closing he pointed to the new conditions under which woolen and worsted manufacturers are called upon to do business and the need of cooperation in meeting and overcoming foreign competition.

After the reading of the reports by the secretary and treasurer, the examiners' committee made their report. This proved to be the most interesting feature of the meeting owing to the exposure of the outrageous abuses in the examination of goods and allowance of claims for imperfections. Following is the report in part:

The examiners' committee which, as you of course know, was appointed for the purpose of investigating the system, or lack of system, that prevails in the matter of returns, rejections and unjust claims, has given a lot of time and thought in an effort to work out a plan by which the unjust

return of merchandise and excessive claims could be reduced to a minimum. The association has sent to its members several recommendations in order to make them more conversant with what has been going on. We discovered a lot of things, that, while they were not new, were startling when freely admitted by both adjusters and spongers.

In the first place, we found that nearly every adjuster in the market had more business than he could possibly attend to and that mills and commission houses have been allowing claims and taking back goods, that not only have never been examined by adjusters, but have never been seen by them. They get reports duly signed by adjusters, but it is a physical impossibility for the adjuster to examine more than a very small portion of the merchandise claimed upon. For instance, one adjusting concern represents 95 mills and commission houses, and aside from the men who compose the firm they have two young men who are supposed to examine all the goods. Another firm has 55 mills and commission houses, another 63, another 52 and another 32. It is not an exaggeration to state that not more than 10 per cent. of rejected goods or goods on which claims are made are ever looked at or examined by the adjusters. On the other 90 per cent. they simply take the spongers' say-so regarding their condition, either sign or rubber-stamp a slip, and the claim is then passed by the mill or commission house as O. K., without question.

We also found that one adjuster examines for both mills and cloth jobbers. In one instance, where the mill would not allow the jobber's claim, his argument to the jobber was:

"If you had hired me as your examiner, I could settle all such cases, without even referring them to the commission house, for I am both judge and jury."

This and innumerable similar experiences, with which it is unnecessary to take up your time, lead your committee to the conclusion that the prevailing system of examination throughout the piece goods market is a farce and will continue to be so while manufacturers allow claims in the present lax way and employ adjusters who have more business than they can take care of.

As our investigations progressed we discovered that there were certain improvements in the prevailing methods that could be effected immediately, and with this in mind, a communication was addressed to all members, embracing recommendations that could be put into immediate effect. For your information we repeat these recommendations here:

RECOMMENDATIONS

No. 1. All pieces to be marked at head end with stencil or punch, and on board end with piece number stenciled or stitched on cloth.

No. 2. All piece goods tickets to be stamped with date of invoice.

No. 3. All goods sold as a job to be stamped as follows:

"It is understood that these goods, being sold off-price, are not subject to return or claims of any description, except for short measurement. Goods to be merchantable all or none."

This stamp should be placed on the copy of order, bill and each piece goods ticket.

No. 4. All sponging houses, whether belonging to the Spongers' Association or independent, to be requested to furnish selling agents or commission houses, either weekly or semi-monthly, with a list of all goods remaining in their possession which have been in dispute, whether signed for return or not.

No. 5. No adjuster to be employed by a mill or commission house who also represents a jobber.

No. 6. Allowances for apparent imperfections should be made on the piece goods tickets as at present, but pieces be not strung.

A resolution was adopted admitting top manufacturers and yarn spinners to active membership. The same resolution provided that sellers of yarn and tops should be admitted to associate membership. The president of the association was authorized to appoint a representative to act with other associations for the purpose of suppressing and prosecuting bribery and improper trade practices in the sale of mill supplies.

President Strong of the association was toastmaster at the banquet. The banqueters were entertained by John Kendrick Bangs who spoke on "Salubrities I Have Met."

THE HOME MARKET CLUB

The annual meeting of the Home Market Club, held last month, resulted in the election of the following officers:

President, W. B. H. Dowse of Boston.

Vice-presidents—John Hopewell, Newton; Lyman B. Goff, Pawtucket, R. I.; Joseph Metcalf, Holyoke; Wm. M. Wood, Boston; George M. Whiting, Whitinsville; F. A. Sayles, Saylesville, R. I.; Arthur H. Lowe, Fitchburg; George A. Hammond, Putnam, Conn.; Edward H. Haskell, Boston; J. J. Dewey, Quechee, Vt.; P. F. Amidon, Wilton, N. H.; Frederic C. Fletcher, Boston; L. D. Cole, Newburyport; Arthur B. Daniels, Adams; James E. Osborn, Fall River; George Park, Dexter, Me.; F. W. Estabrook, Manchester, N. H.; Charles H. Pearson, Brookline; Lew C. Hill, Boston; Calvin D. Paige, Southbridge; Chester W. Lyman, New York; Charles T. Paye, North Attleboro; Albert A. Jenks, Pawtucket, R. I.; E. J. Seward, Worcester, Mass.

Executive Committee—The president, secretary and treasurer by virtue of their offices, and Franklin W. Hobbs, Boston; R. P. Snelling, Newton Upper Falls; A. G. Pollard, Lowell; Richard S. Russell, North Andover; William M. Butler, New Bedford.

Advisory Board—The ex-presidents: Wm. H. Bent, Taunton; William B. Plunkett, Adams; George A. Draper, Hopedale; Charles H. Hutchins, Worcester; James R. MacColl, Providence.

Directors, term expiring 1916—W. K. Dana, Westbrook, Me.; Charles Sisson, Providence, R. I.; Eben D. Bancroft, Hopedale; W. F. Shove, Fall River; Lewis R. Speare, Boston; C. T.

Plunkett, Adams; Andrew G. Pierce, Jr., New Bedford; C. B. Smith, Fitchburg.

THE AMERICAN COTTON MANUFACTURERS' ASSOCIATION

The meeting of this organization will be held in New York on May 26 and 27, 1914, the invitation of the Merchants' Association of New York to hold the meeting in that city having been accepted. This is the first time that the American Association has held a meeting as far North as New York. With the exception of the meetings held at Washington, the May convention will be the first one to be held north of the Mason and Dixie line, and it is expected that a large number of manufacturers from both sections of the country will be present.

THE ARTIFICIAL RIPENING OF COTTON

Many advantages are claimed for a process of ripening cotton by artificial means which is controlled by the Hall Cotton Reclaiming Co. At present only the ripe bolls of cotton are picked and as the cotton matures at different periods it is necessary for the picker to make a selection. This causes loss of time and much waste of cotton. By the Hall process all the bolls are gathered at a comparatively early stage in their development and the maturing process is then carried on artificially so that the entire crop is matured at the same time. By this means it is claimed the yield is increased and the cost of production decreased. Test of two bolls, one matured naturally and the other artificially by means of the Hall process were made by L. DeCosta Ward of the Philadelphia Textile School. They showed practically the same length of staple in both cases with the artificially matured fibers possessing greater strength. The seed from the cotton bolls was tested by W. J. Williams, government chemist at the United States Arsenal, Frankford, Pa., who reports that the oil and fat in the naturally ripened seeds amounted to 32.32 per cent., and in the artificially reopened seeds 34.64 per cent. T. S. Cave of Barnwell, S. C., has carefully investigated the process and placed an order for a maturing apparatus. Mr. Cave writes us as follows in regard to the matter:

I have seen the Hall maturing machine in operation, maturing and opening green cotton bolls in two hours that would not have opened naturally in the fields in ten days and I believe that in time not far distant the entire cotton crop will be opened by the Hall process. I carried with me last week to Philadelphia a lot of immature frost-bitten bolls that would never have opened in the fields, placed them in the Hall machine at the Commercial Museum and saw them opened in two hours. I regard the Hall process as one of the greatest inventions of the age.

THE SOUTHERN NEW ENGLAND TEXTILE CLUB

A meeting of this club was held at the Narragansett Hotel, Providence, R. I., on November 20. The feature of the occasion was an address by Gov. Pothier of Rhode Island, who devoted special attention to the business situation and the necessity for protection against the competition of foreign mills producing goods with the operatives working at wages far below the American level. After the Governor concluded his address many of those present accepted the invitation of Walter T. Phipps, secretary of the American Silk Spinning Co., of Providence, to a dinner at the Turks' Head Club.

A COTTON PICKER'S HELPER

By ALBERT HENDERSON, Albany, Ga.

This machine consists of a vehicle on three wheels with one wheel in advance of the other two and supporting a separate frame attached to the main frame by a swivel joint. The other two wheels are fastened to an axle which carries a loose wheel having a pawl that engages the teeth of a ratchet wheel when the loose wheel is revolved in the forward direction. The ratchet is fastened to the axle. The wheel is revolved by the means of a chain which has one end secured to the wheel and wrapped one time around the wheel and the other end secured to a lever. A lighter chain is wound in the opposite direction around the small hub of the wheel, one end being attached to the hub and the other to a spring which acts in opposition to the force of the lever. The movement of the wheel is reversed by the backward and forward movement of the lever and spring.

The vehicle is driven forward by pulling the lever that unwinds the chain and causes

the pawl to engage the teeth of the ratchet, which drives the axle and the two hind wheels forward. There is also a second lever that is hinged near the back of the frame and passes along the side to the front where it is convenient for the operator to place his foot upon it and press down. This action draws the main lever forward a short distance by means of a light chain that links the two levers together. This lever is used when the operator desires to move a very short distance in very thick open cotton. It carries the machine only six inches, the main lever carrying it four feet. The main lever is used in cotton that is irregular. The foot lever will be used most, as in picking cotton the operator does not want to move more than six inches, in which case he will have the use of his hands at all times. Above the vehicle is a wire frame something on the order of an umbrella frame, which can be any desired shape, round, square or otherwise. The frame is covered by a suitable cloth and can be adjusted to keep the operator in the shade. People who have never picked cotton in the sun in Georgia and Mississippi do not know what hot weather is. A revolving seat is placed on the front end of the frame so that a person seated there can easily change from right to front or left face instantly and with but little exertion. He sits in a position to part the limbs of the cotton stalks so that he can move the vehicle easily and without injuring the stalks in any way. The seat is so low that a child can reach any cotton that may have fallen to the ground. If the picker gets tired of sitting he can stand and pick without any difficulty. A large bag is carried on the rear of the machine. This bag is held open by a steel wire frame and is always to the right or left, whichever way the operator is facing or at his back when he is facing the front. This bag will carry about 250 or 300 pounds of cotton and can be supplied by a new bag if the load becomes too heavy, which may happen twice a day. I believe that I have perfected the best kind of a device to help gather the cotton. I do not believe there will ever be a machine made that will take the cotton from the boll. The human hand is the only thing that will ever be successful in picking cotton.

The Textile World Record's Report of Mill Construction for 1913

So far as the total number of new textile mills is concerned the record of mill construction in the U. S. has been fairly uniform for two years, the number being 265 for 1912 and 277 for 1913. The number for 1913 is also in close correspondence with

to the fact that in this section the goods are finer than in other parts of the country, and consequently a lowering of the petition with foreign mills. The location of new cotton mills in 1913 means a wider distribution of the industry, a tendency that should be encouraged in order to check the

NEW COTTON MILLS.

New England States	No.	Spindles	Looms
Maine.....	1	75,000	2,000
Massachusetts.....	3	6
New Hampshire.....	1	50
Rhode Island.....	2
Southern States			
Alabama.....	3	45,000	1,200
Georgia.....	1	20,160	700
North Carolina.....	8	90,600	1,280
South Carolina.....	1	20,000	500
Virginia.....	1	75,000	2,200
Middle States			
Arkansas.....	1	7,000	104
Pennsylvania.....	5	72
		6	1,700
		27	8,112

NEW KNITTING MILLS.

New England	No.	1913	1912	1911	1910	1909	1908	1907	1906	
Connecticut.....	2									
Massachusetts..	4									
New Hampshire	1									
		7								
Middle States										
Maryland.....	1									
New Jersey.....	8									
New York.....	18									
Pennsylvania...	59									
		86								
Western States										
California.....	4									
Illinois.....	3									
Indiana.....	3									
Michigan.....	3									
Ohio.....	3									
Oklahoma.....	1									
Oregon.....	1									
Utah.....	2									
Wisconsin.....	4									
		25								
Southern States										
North Carolina..	17									
South Carolina..	1									
Tennessee.....	6									
		24								
		142	112	113	104	92	83	103	79	

the average (269) for the preceding ten years. This indicates a healthy confidence in the future on the part of textile manufacturers. The number of cotton mills shows a decrease from 1912; the knitting and silk

COMPARISON OF NEW MILL CONSTRUCTION FOR LAST TEN YEARS.

	1913	1912	1911	1910	1909	1908	1907	1906	1905	1904
Cotton.....	27	37	32	67	80	47	64	74	33	48
Wool.....	24	24	20	31	47	23	25	56	38	45
Knitting.....	142	122	92	113	105	94	83	103	79	111
Silk.....	54	46	38	34	37	33	51	36	53	49
Miscellaneous....	30	36	26	29	20	25	39	34	42	37
Totals	277	265	208	274	289	222	262	303	245	290

mills an increase, while the number of new woolen and worsted mills is the same as last year.

In the cotton industry the extensions and improvements made by old established mills, many of these enlargements more extensive

evils of industrial concentration. The twenty-four woolen and worsted mills are small plants and fairly well distributed. Eight of the twenty-four woolen and worsted mills are equipped with carding, combing or spinning machinery, the others being weaving mills or for the manufacture of felts, wadding and other wool goods.

Sixty per cent. of the new knitting mills are located in three States, Pennsylvania,

COMPARISON OF SPINDLES IN NEW COTTON MILLS FOR THE LAST ELEVEN YEARS.

	1913	1912	1911	1910	1909	1908	1907	1906	1905	1904	1903
New England.....	75,000	94,400	170,500	468,714	599,000	115,000	113,000	171,000	100,800	161,184	135,000
Southern States.....	250,760	437,000	172,000	214,028	527,528	91,193	294,745	294,956	97,290	55,472	281,752
Middle and Western.....	7,000	1,700	4,920	12,500	79,968	3,500	10,250	27,040
Totals	332,760	533,100	347,420	695,242	1,206,496	209,693	417,995	492,996	198,720	216,656	416,752

than good-sized new mills, shows that the tendency has been towards strengthening existing organizations rather than toward launching new enterprises. New England's comparatively modest showing being due

New York and New Jersey. The Southern States have twenty-four of the mills, a decided increase as compared with 1912, when only five new mills were reported from that section. The number of new knitting mills

is the largest on record and is due in a large measure to the substitution of knitted articles of outer apparel for the products of clothing manufacturers, as pointed out in an

cated by the reports of new mills in Virginia and West Virginia.

The record of enlargements and improvements supplies gratifying proof of the healthy condition of the industry. Manufacturers have strengthened their plants by extensions and renewals in preparation for the business which they believe will have to be done in order to supply the demand for textile products of all kinds.

NEW SILK MILLS.

	No.	1913	1912	1911	1910	1909	1908	1907
Connecticut	No.							
Broad Silks	1							
Braids	1							
Illinois			2					
Neckwear	1		1					
Massachusetts								
Braids	1		1					
New Hampshire								
Ribbon	1							
New Jersey								
Broad Silks	10							
Throwing	6							
Ribbons	5							
New York			21					
Broad	2							
Trimmings	5							
Pennsylvania								
Broad	5							
Ribbon	7							
Throwing	5							
Raw	3							
Rhode Island								
Broad Silks	2							
Virginia								
Broad Silk	2							
West Virginia								
Throwing	1							
Total		54	47	38	34	37	32	51

editorial on knitting mill expansion, published in September.

The tendency to concentrate is still strong in the silk industry, 41 mills, nearly four-fifths of the total, being located in New

NEW WOOLEN AND WORSTED MILLS.

	No.	1913	1912	1911	1910	1909	1908	1907	1906
New England	No.								
Connecticut	1								
Maine	1								
Massachusetts	4								
Rhode Island	1								
Vermont	1								
Middle States			8						
New York	2								
Pennsylvania	11								
Indiana	1								
Western States									
California	1								
Wisconsin	1								
Total		24	23	17	31	47	22	25	56

Jersey and Pennsylvania. A larger number than usual of these new mills, however, are in cities and towns removed from the most congested centers and the silk manufacturing trade give evidence of a desire to branch out into neighboring states, as indi-

BUSINESS CONDITIONS IN EUROPE

From an Occasional Correspondent

Basel, Switzerland, Nov. 25, 1913.

Editor Textile World Record:

Replying to your recent inquiry I find that nearly all the goods known as "duvety" are manufactured and finished in France where there is a monopoly of this style of finish.

You may be interested in knowing that from 70,000 to 80,000 looms in South Germany and Alsace will be shut down every Monday during the first quarter of 1914. This will compel the spinners to curtail production in a short time. There is an over production throughout Europe and the curtailment decided upon is the only possible course in the face of the ruinous prices in the weaving trade.

THE BOSTON WOOL TRADE ASSOCIATION

This organization recently held its annual meeting and elected the following officers:

President, Jacob F. Brown, of Brown & Adams; vice-president, Arthur E. Gill, of Dewey, Gould & Co.; secretary and treasurer, George W. Benedict. Executive committee—Jacob F. Brown, Arthur E. Gill, Ludwig Eisemann, of Eisemann Bros.; Albert W. Elliott, of Jeremiah Williams & Co.; William E. Jones, of Hallowell, Jones & Donald; A. Koshland, of J. Koshland & Co.; Charles J. Nichols, of Hills & Nichols. Arbitration committee—Louis Baer, of Eisemann Bros., chairman; Charles F. Avery, of Mauger & Avery; Lewis Balch, of J. H. Wheelock & Co.; Matthew Luce, of Luce & Manning; Walter P. Wright, of Wright Bros.

Of the total output of gingham during 1909, Massachusetts produced 26 per cent. and North Carolina 20.8 per cent., as compared with 19.4 and 28.6 per cent. respectively in 1899.

New Mill Construction for 1913

(A summary will be found in the Monthly Comment of this issue.)

EXPLANATION OF ABBREVIATIONS: S=steam power; W=water power; E=electric power; D=dye house.

NEW COTTON MILLS.		Spindles	Looms
ALABAMA.			
Ozark. Ozark Cotton Mill Co.; \$100,000; J. D. Holman, pres.; H. O. Dowling, treas.; W. D. McNeill, mgr. and buyer; 16s to 30s Hosiery Yarns. (Building brick mill, 100 by 300 ft., and steam power house, 40 by 70 ft. Start mfg. about June, 1914.)	5,000
Ragland. Alabama Textile Co.; building weaving mill; organization of company not completed; J. Riddell in charge.
Sylacauga. Eva Jane Mills; White and Colored Cotton Goods; built by Avondale Mills, Birmingham. (Four-story mill, 445 by 140 ft.)	40,000	1,200	..
ARKANSAS.			
Helena. St. Francis Cotton Mills; new mill to make Osnaburgs and Sheetings; electric. (Taken over spinning machinery of Premier Cotton Mills and added looms.)	7,000	104	..
GEORGIA.			
Chickamauga. Crystal Springs Bleachery Co.; D. A. Jewell, pres., treas. and buyer; A. E. Yates, supt.; Bag Goods; electric; sell direct. (Three-story brick mill, 375 by 131 ft., under construction; begin manufacturing Jan. 1.)	20,160	700	..
MAINE.			
Lewiston. Bates Mfg. Co.; built new weave shed covering 4 1/2 acres, to give increase of 75,000 spindles and 2,000 looms.	75,000	2,000	..
MASSACHUSETTS.			
Boston. Alpha Waste Products Co.; 1536 Hyde Park Ave., Hyde Park; \$50,000; George S. Wood, pres. and buyer; Chas. E. Peakes, treas.; Edw. Heaton, supt.; Cleansing and Processing of Oily Cotton Waste; steam; sell direct; office, 620 Atlantic Ave., Boston.
Boston. Noone, C. H., Co.; 121 Lamartine St., Jamaica Plain; "Flatworksheets," 7 1/2 oz. Cotton Laundry Duck, 105, 115 and 125 in. wide.	..	6	..
Framingham. Standard Woven Fabric Co.; built new 3-story cement mill with greatly increased capacity; removed plant from Worcester.
NEW HAMPSHIRE.			
Keene. Keene Artistic Narrow Web Co.; Laces, Belts and Narrow Fabrics. (Branch of N. H. Artistic Web Co., Barnstead, N. H.)	..	50	..
NORTH CAROLINA.			
Charlotte. Thrift Mfg. Co.; \$600,000; E. A. Smith, pres.; Geo. B. Hiss, treas.; J. W. Kidd, supt.; Brown Sheetings; electric; Wilson & Bradbury, Phila. and N. Y., s. agts. (Succeeded Thayer Mfg. Co. and completed new plant.)	22,000	580	..
Concord. Roberta Mill; constructed new mill on old site; P. M. Keller and John C. Rankin; Hosiery and Hard Yarns, 14s to 26s.	2,000
Greenville. Greenville Cotton Mills, Inc.; \$100,000; J. G. Moye, pres.; E. B. Higgs, vice-pres. and treas.; W. H. Norris, mgr. and buyer; 8 to 18 Cotton Yarns; steam.
(Will build mill.)	5,000
High Point. Highland Cotton Mills, Inc.; \$250,000; J. H. Adams, pres. and buyer; J. E. Mills, treas.; L. R. Gilbert, supt.; 10s to 20s Hosiery Yarns; electric. (Built reinforced concrete mill, 390 by 125 ft.)	12,000
Kannapolis. Cabarrus Cotton Mills. Branch of Concord. (Under construction Nov., 1913.)	20,000
Landis. Corriher Mills Co.; \$47,500; C. J. Deal, pres.; L. A. Corriher, treas.; G. O. Lipe, supt.; 24s Hosiery Yarns; treas. and supt., buyers. (Begin mfg. Jan. 1.)	4,000
Lexington. Erlanger Cotton Mills; \$500,000; Cotton Cloth for B. V. D. Underwear; steam and electric. (Under construction Nov., 1913.)	25,600	680	..
Salisbury. Littmann Mills, Inc.; \$50,000 (authorized); I. Littmann, pres., treas. and buyer; L. A. Henley, supt.; Mosquito Netting; dye (piece); steam; buy 1/30, 1/40 cones and warps.	..	30	..
PENNSYLVANIA.			
Philadelphia. Carlisle Mills; Arthur Boeschenstein, prop.; 243 E. Ontario St.; Turkish Towels, Wash Cloths, etc.; buy 10, 12, 14/1, 20/2.	..	9	..
Philadelphia. Cheltenham Towel Mills; Mascher and York Sts.; High Grade Turkish Towels; F. Tausend Com. Co., s. agts.	..	28	..
Philadelphia. Royle & Craven; Oxford and Josephine Sts.; Frankford; Cotton Quilts.
Philadelphia. Sherwood, A. G.; Upholstery Co.; A. G. Sherwood, prop.; 1516 Callowhill St.; Upholstery Trimmings; sell direct.	..	27	..
Philadelphia. Standard Bed Spread Mills; Max Davidson, prop.; Jasper and Orleans Sts.; Cotton Bed Spreads.	..	8	..
RHODE ISLAND.			
Hopkinton. Yawgo Line & Twine Co.; \$25,000; Geo. B. Langworthy, pres.; Fred'k Hill, treas.; Osma Edwards, mgr. and buyer; Yarns, Twine and Cordage; dye, steam and water; sell direct.
Pawtucket. Rhode Island Textile Co.; \$10,000; A. L. Kelley, Jr., pres.; Geo. F. Kelley, treas.; John H. Conrad, mgr. and buyer; Braids; 300 braiders.
SOUTH CAROLINA.			
Union. Monarch Cotton Mills; built new 4-story mill, 380 by 125 ft., equipped with electric drive.	20,000	500	..
VIRGINIA.			
Danville. Riverside & Dan River Cotton Mills; completing installation of equipment in new spinning mill and weave shed, including large number of electric motors for power distribution.	75,000	2,200	..
CANADA.			
Ontario, Galt. Narrow Fabric Weaving & Dyeing, Ltd.; \$40,000; Geo. Hancock, pres.; E. Wilkinson, treas.; P. F. Fitch, supt.; Cotton and Silk Labels, Shoe Straps, etc.; dye and finish; steam and electric; buy cotton and silk yarns.	..	10	..
Quebec, Montreal. International Braid Co. of Canada, Ltd.; 373 Aqueduct St.; R. B. Hamilton, agt.; Boot, Shoe and Corset Laces. (Branch of East Braintree, Mass.)
Quebec, Sherbrooke. Canadian Connecticut Cotton Mills, Ltd.; \$1,750,000; H. L. Burrage, pres.; Tracy S. Lewis, treas. and buyer; Obadiah Butler, mgr.; Special Cotton Fabrics. (Building main mill, 250 by 112 ft., two and three stories, storehouse 100 by 100 ft. and power house 50 by 40 ft.)

NEW WOOLEN MILLS.

No. Sets
Cards
Looms

CALIFORNIA.

Long Beach. California Woolen Mfg. Co.; \$200,000; S. J. Kent, pres.; R. Z. McCourt, treas.; J. F. McAfee, supt. and buyer; Flannels, Blankets and Cassimeres; dye and finish; electric. (Equipment of Topeka Woolen Mfg. Co., Topeka, Kan.) 3 11

CONNECTICUT.

Elmville. Nicholas & Nicholas; Geo. K. Nicholas, treas., mgr. and buyer; Men's and Women's Worsted Goods; sell direct; buy 2/20 to 2/40 worsted yarns. 2

INDIANA.

Mexico. Mexico Woolen Mills; \$25,000; C. H. Black, pres.; Geo. Willson, treas.; Knitting Yarns, Bed and Horse Blankets and Auto Robes; 1,200 spindles; dye (raw stock); water... 3 6

MAINE.

Pittsfield. McGilvery-Cummings Co.; \$20,000; Danl. E. Cummings, pres.; William McGilvery, treas. and agt.; All Wool Shoddies; dye; electric; sell direct.

MASSACHUSETTS.

Boston. Middlebrook Wool Combing Co., Inc.; 310 Border St., East Boston; \$250,000; J. A. Middlebrook, pres.; J. W. Coggeshall, treas.; Commission Wool Combing; 20 combs. 24
Lawrence. Lord, Ernest & Son; Broadway and Cross St.; Worsteds.
South Framingham. Emmons, A. W., Co.; 37 Wellington Ave.; \$125,000; A. W. Emmons, pres.; Geo. L. Hanna, treas. and buyer; Harry Haigh, supt.; Ladies' Wool Felt Hats and Bodies; steam and electric; dye (piece); sell direct. 2
Westboro. Bay State Felt Co.; \$250,000; Jonathan Whitaker, pres.; Benj. Kenrick, treas.; Albert Crabtree, supt.; Hat Felts.

NEW YORK.

Auburn. Firth Carpet Co.; Seamless Scotch, Chenille and Axminster Rugs; electric. (Branch of Firthcliffe.)
Waterford. Waterford Woolen Co., Inc.; 55 Ballston St.; \$20,000; O. A. Saeltzer, pres. and buyer; H. B. Brooks, treas.; Wool Shoddy; 3 pickers; dye and carbonize; steam and electric. (Burned Oct., 1913. To be rebuilt.) 5

PENNSYLVANIA.

Philadelphia. Galashan, John; Mascher and Turner Sts.; Custom Weaving.
Philadelphia. Harkel Co.; Orthodox and Horrocks Sts.; Frankford; Woolen and Worsted Fabrics.
Philadelphia. Jeeson Mfg. Co.; 2nd St. and Columbia Ave.; Wool, Worsted and Cotton Dress Goods and Men's Wear. 8
Philadelphia. Klenk-Landis Co.; \$10,000; James Klenk, pres.; Lewis Klenk, treas.; Wm. S. Landis, mgr.; Woolen and Merino Yarns, 8 to 40 cut; 2,300 mule spindles; sell direct. 3
Philadelphia. Myers-Jolesch Co.; Howard St. and Montgomery Ave.; Woolen and Worsted Cloakings; N. Y. office, 334 Fourth Ave. 16
Philadelphia. Rooba Mfg. Co.; 1543 Ruan St.; Chas. Mayrus, mgr.; Dress Goods and Men's Wear Worsteds on Commission; steam; sell direct. 10
Philadelphia. Saxonia Dress Goods Mills; built new plant at Westmoreland and C Sts., consisting of 4-story factory building, 180 by 53 ft., warehouse, 152 by 162 ft., and power house for steam and electric drive, 40 by 64 ft.
Philadelphia. Sykes-Geiger Co.; Frankford Ave. and Van Dyke St., Frankford; \$30,000; Woolen Carpet Yarns.
Chester. Nelson Spinning Co.; 11th and Walnut Sts.; \$10,000; W. G. Nelson, pres.; S. L. Irving, treas.; Wool and Merino Yarns, 2/5 to 2/25; 2,160 spindles. 4

Erie. Puritan Woolen Mills Co.; 228 West 12th St.; \$10,000; F. H. Paul, pres. and buyer; D. H. Hill, treas.; Wool Batts and Wool Filled Comforts; electric; sell direct. 1
Parkers Landing. Parker Woolen Mills; \$10,000; Lester Fleming, pres.; Arthur E. Conn, treas.; J. O. Conn, supt.; Woolen and Merino Yarns, 6 to 26 cut; gas; sell direct; treas. and supt., buyers. 1

RHODE ISLAND.

Warren. Warren Worsted Mill; \$150,000; Walter A. Guile, pres. and gen. mgr.; Clarence A. Brouwer, treas.; Fine Worsteds; electric. (Brick mill, 60 by 300 ft., under construction.).... 60

VERMONT.

North Montpelier. Little Woolen Co.; \$10,000; succeeded Little Mfg. Co.; built new mill, 150 by 54 ft., two stories high, to replace plant burned.

WISCONSIN.

Frederic. Frederic Woolen Mill; Flannels, Blankets, Mackinaws and Yarns. 1 4

CANADA.

Ontario, Toronto. Dominion Wool Stock Mills, Ltd.; 203 First Ave.; \$40,000; O. E. Woods, pres. and buyer; C. R. Peterkin, Jr., treas.; C. M. Wilson, supt.; Coarse and Fine Shoddy and Felted Jute and Cotton Mattress Stock; dye; electric; sell direct. 3

NEW KNITTING MILLS.

No. Ktg.
Machines

CALIFORNIA.

Los Angeles. Los Angeles Knitting Co.; 3512 San Pedro St.; \$25,000; Emil Schultz, mgr.; Richard Gerrisch, supt.; Sweaters, Bathing Suits and Jerseys; 8 sewing machines; Richard Gerisch, buyer. 14
Los Angeles. Western Knitting Mill; 2614 S. Main St.; A. P. Nollan, supt. and buyer; Men's, Women's and Children's Sweater Coats; 4 sewing machines; sell direct. 4
San Francisco. Western States Knitting Mills; 2550 San Bruno Ave.; H. L. Schneider, pres. and buyer; Sweater Coats and Fancy Knit Goods; 4 sewing machines. 5
West Berkeley. Gunzel, C.; 2413 Eighth St.; Sweater Coats.

CONNECTICUT.

Hartford. Lion Mills; Jos. S. Hellpern and Norman Gross; 6 Village St.; Men's and Women's Full Fashioned Sweater Coats; 7 sewing machines. 15
Norwich. Coronet Knitting Co.; C. W. Briggs, prop.; 95 Chestnut St.; Robt. Bodycott, supt.; Medium and High Grade Sweater Coats; electric; sell direct. 3

ILLINOIS.

Chicago. Marshall Field & Co.; 1248 Marianna St.; Geo. U. Clark, supt.; Men's and Boys' Union Suits; 75 sewing machines; F. L. Drane, buyer; buy 9 to 60 cotton, 40 to 70 worsted, single and ply. 30
Chicago. Shaker Knitting Mills Co.; Franklin and Huron Sts.; \$25,000; D. C. O'Shea, pres. and buyer; J. M. Feldhake, treas.; A. Hezinger, supt.; Sweaters, Toques, Collarettes; 10 sewing machines; sell direct. 20
Chicago. Vassar Swiss Underwear Co.; building new 4-story concrete mill, to cost about \$750,000, giving 6 acres of floor space and to be ready for occupancy soon after the first of the year.

INDIANA.

Evansville. Evansville Hosiery Co.; Olive and Canal Sts.; \$10,000; R. E. Losey, mgr.; 84-needle Half Hose; F. Marvin Austin, buyer. 15
Fort Wayne. Anthony Hosiery Mills; \$15,000; Morris Levy, pres.; Abe Levy, treas.; H. M. Kahn, supt.

and buyer; Lisle and Mercerized Ladies' Hosiery; 30 knitting and 2 sewing machines; electric; sell direct. 20
 Fort Wayne. B. & B. Knitting Co.; 726 Runion Ave.; \$10,000; Geo. H. Butler, pres.; Adam Baus, Jr., treas.; Sweaters and Athletic Goods; electric; sell direct. 4

MARYLAND.

Emmitsburg. Union Mfg. Co.; Hosiery; gasoline. (Branch of Frederick.) 30

MASSACHUSETTS.

Franklin. Brown & Sons Mfg. Co.; \$25,000; W. F. Brown, pres.; W. F. Brown, Jr., treas.; Underwear and Hosiery.
 Gloucester. Ipswich Mills; Vincent St.; E. H. Hills, supt.; Men's Cotton Hosiery; electric. (Branch of Ipswich, where goods are dyed and finished.) 129
 Springfield. Higgins, R. G. & Co.; 22 Salem St.; Knitted Silk Neckties.
 Waltham. Clayton Mfg. Co.; Edwin Clayton, gen. mgr.; Ladies' Union Suits and Two-Piece Underwear; 12 sewing machines; electric; sell direct; buy 18 to 40. 3

MICHIGAN.

Bay City. Amonica Knitting Works; 1116 Garfield Ave.; Wm. Hanson, pres.; Anthony Miller, treas., supt. and buyer; Men's, Women's and Children's Hosiery; dye; electric; sell direct. 10
 Grand Rapids. Williams Glove & Gauntlet Co.; 249 Pearl St.; Geo. E. Bennett, supt.; Astrakhan Cloth and Other Knitted Fabrics; 12 sewing machines; dye (piece); steam and electric; Francis H. Holmes, N. Y., s. agt.; Geo. T. Williams, buyer. 8

MINNESOTA.

Litchfield. Litchfield Knitting Mill; P. C. and N. C. Nielsen Co., props.; \$10,000; Underwear for Men, Women and Children; 3 sewing machines; electric. 5
 Minneapolis. Lake Street Knitting Works; Fred Palm Dahl, prop.; 1705 E. Lake St.; Sweater Coats and Stockings; 3 sewing machines; electric; sell direct. 10
 St. Paul. Capitol Knitting Co.; Capitol Suspender Co., props.; Sweaters and Sweater Coats; L. D. Horn, buyer.

NEW HAMPSHIRE.

Lakeport. Laconia Knitting Co.; Fred M. Swain, pres.; Wm. T. Swain, vice-pres.; Chas. H. Perkins, sec. and treas.; Astrakhan, Stockinette, Jersey and Eiderdown Cloth; electric.

NEW JERSEY.

Boonton. Boonton Hosiery Co.; \$100,000; Geo. E. Fichtner, pres. and treas.; Ladies' Full Fashioned Silk Hosiery; full fashion machines; electric. (Mill under construction.) 24
 Medford. Powell Knitting Co.; Seamless Hosiery; Geo. J. Graff, supt.; gas; mill building erected. (Branch of Philadelphia.)
 Newark. Groblue Knitting Mills; 39 S. Eighth St.; \$100,000; T. Groedel, pres.; Harry Groedel, treas.; Jacob Blume, buyer; Sweaters and Bathing Suits; 4 sewing machines; electric; sell direct. 10
 Newark. N. J. Textile Art Corp.; 61 Arlington St.; Oswald Schenke, pres.; C. T. Meiner, treas.; F. E. M. Schenke, supt. and buyer; Hosiery; 5 sewing machines; steam; sell direct. 20
 Paterson. Atlas Silk Hosiery Co.; East Railway and Kentucky Ave.; \$125,000; Max Richter, pres.; Wm. Nebel, vice-pres. and supt.; E. A. Nebel, treas. and buyer; Women's Fine Gauge Full Fashioned Silk Hosiery; H. Richter's Sons, 627 Broadway, N. Y., s. agts.; buy tram silk and merc.
 Paterson. Simon & King; 166 Ward St.; Knitted Silk Neckties. 4
 Union Hill. Atlas Knitting Mills; 124 Main St.; \$15,000; I. Rogosin, pres.; J. Epstein, treas., supt. and buyer; Boys' Sweater Coats; 12 sewing machines; sell direct. 8
 Vineland. Vineland Glove & Hosiery Mill; Thomas Braithwaite, prop.; Howard Jameson, supt.; Seamless Hosiery and Gloves; steam and gas; buy cotton, merc. and worsted. 28

NEW YORK.

Brooklyn. Ess & Emm Knitting Mills; M. Simon and H. Mallett; 345 Throop Ave.; Shaker Sweaters; electric; sell direct. 5
 Brooklyn. Fashion Knitting Works; 206 Manhattan Ave.; Sweater Coats; 5 sewing machines. 10
 Brooklyn. Full Fashion Silk Hosiery Co.; 30 Main St.; \$200,000; Hosiery and Gloves.
 Brooklyn. Infant Wear Knitting Corp.; 40 Penn St.; \$15,000; H. Parra, pres., treas. and buyer; Wm. Richardson, supt.; Infants' and Children's Knit goods; 5 flat, 1 circular and 1 full fashioned knitting machines; 3 sewing machines; steam; sell direct; buy 10 to 30/2, 40 and 60 single. 7
 Cambridge. Superior Mfg. Co.; Finishing Only. (Branch of Hoosick Falls.)
 Clifton Springs. Clifton Springs Knitting Co.; Crane St.; Chas. M. Tinkham and F. J. Daly; Gloves, Caps and Sweaters; electric. 6
 New York City. Art Knitting Mills; 96 Grand St.; \$5,000; Ben Bangser, pres.; J. Rosenbloom, treas.; Knitted Neckwear. 8
 New York City. Boyd & Co.; 2159 Prospect Ave., Bronx; Full Fashioned Silk Hosiery and Underwear; office, Fifth Ave. Bldg. 50
 New York City. Brand, Jos. & Bro.; 521 E. 72nd St.; Astrakhan Fabrics; sell direct; buy 1/10, 1/30 cotton, 2/3, 2/10 wool. 5
 New York City. N. Y. Crown Knitting Works; 135 Grand St.; Harry Kopolsky, mgr. and buyer; Sweater Coats and Bathing Suits; electric; sell direct.
 New York City. Pioneer Knitting Mills, Inc.; 3635 Third Ave.; \$12,000; Jacob Bandes, pres. and buyer; Louis Bandes, supt.; Men's, Boys' and Ladies' Sweater Coats, Jumbo and Shaker Coats a Specialty; 9 sewing machines; sell direct. 20
 New York City. Princely Knitted Neckwear Co.; 433 Broadway; Knitted Neckties; 27 silk spindles; dye; electric; sell direct; Wm. Goldsmith, buyer. 10
 New York City. Schwartz Knitting Mills; 141 W. 36th St.; \$50,000; Nathan Schwartz, pres., supt. and buyer; Knit Cloth and Sweater Coats; 8 sewing machines; dye; electric; sell direct. 20
 New York City. Walker Knitting Mills; Geo. J. Lippmann, prop.; 242 Canal St.; Bathing Suits, Jerseys and Athletic Knit Goods; 6 sewing machines; electric; sell direct. 10
 Niagara Falls. Cataract Knitting Co., Inc.; Ontario Ave. and Tenth St.; \$5,000; Louis Brown, pres.; Isaac Traub, treas.; Sweaters, Hosiery and Underwear.
 Oswego. Chonaguen Textile Mills; 3rd, 4th and Lawrence Sts.; \$10,000; D. H. Conway, pres. and agt.; Thos. H. King, treas.; Jas. A. Shufelt, supt.; Children's Knit Goods; 50 sewing machines; dye; electric. 25
 Foughkeepsie. Lawrence, W. A., Co., Inc.; \$20,000; W. A. Lawrence, pres. and buyer; C. H. Townsend, treas.; C. W. Lawrence, supt.; Knitted Mesh Fabrics, Cotton, Silk and Mercerized; dye; steam and electric; sell direct. 6
 Waterford. O'Lea, L. A.; Knitted Novelties.

NORTH CAROLINA.

Burlington. Southern Hosiery Mills; \$10,000; L. C. Christman, pres. and treas.; C. J. Boland, supt. and buyer; Ladies' Fine Gauge Hosiery; electric; sell direct. 60
 Chapel Hill. Blanche Hosiery Mills Co.; \$15,000; W. S. Robertson, pres.; W. E. Lindsay, treas., mgr. and buyer; J. F. Partin, supt.; Men's, Women's and Children's Hosiery; dye; steam; L. C. Vaughn, s. agt. 75
 China Grove. Lillian Knitting Mills Co., No. 2; Seamless Cotton Hosiery; electric; use 12s and 18s carded; branch of Albemarle. (New brick mill, 50 by 130 ft., erected.) 100
 Connelys Springs. Mull, D. B.; purchased hosiery knitting dept. and dyeing equipment of Ethel Cotton Mills. (Building new mill.) 60
 Durham. North State Knitting Mills; \$24,000; J. S. Carr, C. McD. Carr, W. F. Carr and W. J. Berry; Hosiery.
 Effland. Effland Hosiery Co.; \$50,000; M. P. Effland, pres.; John L. Effland, treas.; Hosiery; steam. (Building new mill.)
 Gibsonville. Gibsonville Hosiery Mill; \$100,000; G. W. Fogleman, J. L. Kernodle, W. C. Michael and others. (May take over business of Burlington Hosiery Mill Co.)

Hickory. Best Knitting Mills; C. Sherman Grove, prop.; Men's Half Hose; electric; sell direct and through H. L. Sanders, N. Y. 24
 High Point. Crown Hosiery Mills; \$40,000; T. H. Kearns, pres.; G. H. Kearns, treas.; Hosiery; dye and finish; steam. (Built 2-story mill and dye house, 100 by 60 ft. and 60 by 40 ft.) 100
 Hildebran. Waldensian Hosiery Mill No. 2; J. A. Cline, gen. mgr. and buyer; Albert Garrou, supt.; Women's Hosiery; electric. (Goods dyed and finished at Valdese.) 60
 Mebane. Durham Hosiery Mills No. 6. Seamless Hosiery. (Branch of Durham.)
 Newton. Ridgeview Hosiery Mills Co.; \$21,000; L. F. Long, pres.; J. A. Gaither, treas. and buyer; Women's Seamless Hosiery; electric. 50
 Statesville. Walton Hosiery Mills; John Walton, Sr. and John Walton, Jr.; 136-needle Men's Half Hose; 7 ribbers; 7 loopers. 24
 Tarboro. Fairview Hosiery Co.; \$20,000; George Howard, pres.; C. A. Johnson, treas.; Hosiery. (Equipping plant with capacity of 260 doz. daily.) ..
 Thomasville. Sellers' Hosiery Mills; Cotton Half Hose; electric. (Branch of Burlington.) 75
 Troy. Troy Knitting Mills Co.; \$35,000; J. C. Hurley, pres.; Barna Allen, treas.; Hosiery; electric. (Building 3-story brick mill, 60 by 100 ft., with 1-story dye house, 40 by 60 ft.)
 Wendell. Wendell Knitting Mills; \$20,000; R. B. Whitley, pres.; O. L. Rowland, treas.; J. L. Hallmen, supt.; Cotton Hosiery; 50 latch needle knitting machines; kerosene; buy 14, 17, 40. (Built new brick mill, 96 by 32 ft.) 50

OHIO.

Cleveland. Lion Knitting Mills Co.; 1051 Power Ave.; \$25,000; L. H. Einstein, treas. and buyer; Fashioned Sweaters and Sweater Coats; sell direct.
 Covington. Imperial Underwear Co.; Finishing; 24 sewing machines. (Branch of Piqua.)
 Greenville. Union Underwear Co.; Men's Union Suits; 50 sewing machines. (Branch of Piqua.) .. 10

OKLAHOMA.

Lawton. Lawton Knitting Mill Co.; H. E. Diehl, Louis Mendlick and J. J. Folk.
 Oklahoma City. Oklahoma Hosiery Co.; \$25,000; T. H. Lindley, pres. and buyer; M. J. Lindley, treas.; J. B. Barker, supt.; Women's Hosiery; 7 sewing machines; dye; electric; sell direct. 100

OREGON.

Portland. Nollan Knitting Co.; 212 1/2 First St.; \$100,000; Henry Nollan, pres., treas. and buyer; Hugo Nollan, supt.; Wool and Worsted Sweater Coats; 12 sewing machines; electric; sell direct. .. 15

PENNSYLVANIA.

Philadelphia. Acme Knitting Co.; E. Thompson and Neff Sts.; \$5,000; Joseph T. North, pres., supt. and buyer; H. M. Lilley, treas.; Silk Neckties, Infants' Hosiery and Novelties; finish; sell direct. 7
 Philadelphia. Advance Hosiery Mills; 2427 N. Mascher St.; Ladies' Cotton Hosiery; steam; F. B. Berlin, N. Y., s. agt.; Edw. Dean, buyer. 25
 Philadelphia. Alland Knitting Co.; 1427 Catherine St.; John M. Anderson and A. E. Allison, props.; Infants' and Children's Hosiery.
 Philadelphia. American Standard Knitting Mills; Brudnick Bros., props.; 1545 S. 7th St.; Sweater Coats; 4 sewing machines. 3
 Philadelphia. Bell Knitting Mills of Penna.; Emil Joseph and Rubin Bros.; 208 N. 4th St.; Sweater Coats and Fancy Knit Goods; 6 sewing machines. 10
 Philadelphia. Delpia Knitting Mills; 2d and Poplar Sts.; Geo. J. Wolf, mgr. and buyer; Chas. J. Sutphen, supt.; Knitted Silk Neckwear; finish; sell direct. 18
 Philadelphia. Elwell, Harry; 1543 Ruan St., Frankford; Silk and Art. Silk Neckties. 30
 Philadelphia. Fairmount Knitting Mills; Haber, Neuman & Co., props.; 123 N. 5th St.; Shaker and Full Fashioned Ribbed Sweater Coats; 15 sewing machines; sell direct; buy woolen and worsted... 20
 Philadelphia. Girard Knitting Mills; 141 N. 3d St.; M. Silver and S. Shumelman, props.; M. Silver, supt. and buyer; Fashioned Sweater Coats; 10 sewing machines; finish; electric; sell direct. 12

Philadelphia. Gray, Wilfred; Knitted Silk Neckties; 2 full fashion frames; finish; sell direct; buy 12, 13, 14 tram; office, 104 N. 6th St.
 Philadelphia. Hub Knitting Mills; 36 N. Third St.; H. L. Peterzell, treas.; A. Cohen, mgr. and buyer; Men's Shaker and Full Fashioned Sweaters; 10 sewing machines; buy wool and worsted. 13
 Philadelphia. Hughes & Bradley Co.; 837 Market St.; \$60,000; Knitted Silk Neckties.
 Philadelphia. Le Fevre, Chas. & Co.; 257 Market St.; Knitted Silk Neckties. 7
 Philadelphia. Miller & Son; 736 Passayunk Ave.; Sweater Coats; sell direct.
 Philadelphia. Ellis, Morris, Co.; 2420 Waterloo St., Kensington; Seaming, Looping and Finishing of Hosiery in the Grey; office, 31 S. Third St.
 Philadelphia. Phoenix Sweater Mills; rear 218 Arch St.; Morris Reisen, supt.; Sweater Coats for Men, Women and Children; 18 sewing machines; sell direct; N. Y. office, 366 Broadway. 18
 Philadelphia. Pillet, Steerman & Co.; 123 N. 3rd St.; Knitted Silk Neckties; buy art. silk and merc. 14
 Philadelphia. Reliable Knitting Mills; Lipschutz & Wenger; 271 S. 5th St.; Sweater Coats; sell direct. 14
 Philadelphia. Safe-Keep Pocket Hosiery Co.; 1211 Filbert St.; E. H. Morningstar, mgr.; Women's Hosiery with Pocket Attached; sell direct; buy 40 to 50 comber S. I. merc.
 Philadelphia. Standard Knitting Mills of Pa.; Cohen & Co.; Alex. Seifert, supt.; Shaker Knit Sweater Coats; 10 knitting and 12 sewing machines; electric; finish; sell direct. 10
 Philadelphia. Union Knitting Mills of Pa.; 527 Market St.; \$15,000; David Frankel, pres. and buyer; D. Rabinovitch, treas.; Sweater Coats; 8 sewing machines; finish; electric; sell direct. 8
 Philadelphia. Woolman Bros.; 44 N. 4th St.; Knitted Silk Neckties; sell direct. 5
 Philadelphia. Wyoming Knitting Mills; 4525 N. Howard St.; Elias Ager, mgr.; Sweaters, Cardigans and Ladies' Vests; 3 sewing machines; sell direct. 4
 Adamstown. Stork, Harry K.; Hosiery; sells in the grey.
 Allentown. Astrachan Company, Ltd.; \$2,500; Astrachan Cloth; 8 knitting heads; electric; Aufmordt & Co., N. Y., s. agts.
 Allentown. Rittersville Waist Co.; J. Fink Thompson, supt.; Children's Waists; 24 sewing machines; electric. (Mill at Rittersville.) 10
 Allentown. Smith, C. G. & C. A.; 314 N. Church St.; Astrachan Cloth and Commission Silk Winding; 4 knitting heads; 6 winding frames. 4
 Bangor. Raub, H. F., Silk Co.; \$20,000; R. S. Raub, pres.; H. F. Raub, treas.; Silk Gloves, Hosiery and Underwear and Jersey Cloth; electric. (Built 2-story mill, 44 by 82 ft., and dye house, 30 by 54 ft.) 4
 Bethlehem. Central Knitting Co.; 12th Ave. and Broad St.; Irvin J. Hunsicker, pres.; Edward S. Buckman, treas. and buyer; Children's Underwear and Misses' Union Suits; 30 sewing machines; electric; Robitscher & Rauch, s. agts. 7
 Bethlehem. Graham & Barnes; Saml. Graham, mgr.; Knitted Silk Neckties.
 Bowmansville. Conestoga Hosiery Co.; W. E. Snader, supt.; 144-needle Half Hose; steam. (Branch of Brownstown.) 40
 Cambridge Springs. Cambridge Springs Knitting Co.; \$20,000; Geo. L. Wade, pres.; N. H. Bertram, treas.; J. A. Bolard, sec. and mgr.; Geo. Cooper, supt.; Ladies' Cotton Underwear; 10 sewing machines; electric. 6
 Carlisle. Interwoven Mills, Inc.; building new mill, 200 by 150 ft., to employ about 400 hands.
 Denver. Gerhardt, John; 144-needle Cotton Half Hose; sell direct. 15
 Galeton. Galeton Knit Goods Mfg. Co.; \$6,000; W. G. Johnson, pres.; David Humphrey, sec. and treas.
 Harrisburg. Modern Textile Co.; 16th and Elm Sts.; \$10,000; J. H. Gingrich, pres.; J. F. Heisley, treas.; J. C. Ewing, mgr. and buyer; Misses' and Children's Underwear; 10 sewing machines; electric. 4
 Hawley. Hanf & Kollmer; Teutonia Mill; Hudson St.; Fancy Knit Goods; 2 sewing machines; gasoline. 4

Hawley. Kaidy Bros.; Church St.; Knit Scarfs and Shawls.	6
Knoxville. Pioneer Mfg. Co.; \$5,000; John E. and G. E. Davis and Fred Walker; Gloves, Mittens, etc.
Lansdale. Tonner & Moyer; Hosiery. (Branch of Norristown.)
Leighton. Zimmerman & Altemose; N. 6th St.; E. Braithwaite, supt. and buyer; Ladies' Shaped Vests; 4 sewing machines; electric.	6
Mifflintown. Juniata Hosiery Mills; Max W. and K. O. Nestler, props.; Ladies' All Silk and Silk Boot Hosiery; 4 sewing machines; steam and gas; sell direct.	20
Milton. Keefer Mfg. Co.; \$25,000; Fred Leonard, N. T. Marsh, Wm. H. Keiser, Howard Keefer; Leggings, etc.
Montello. American Hosiery Mfg. Co.; built new 2-story mill, 40 by 60 ft., and removed here from Reading.
Mt. Carbon. Leaman Knitting Mills; Chas. H. Leaman, prop.; Women's Knit Underwear; 6 sewing machines.	4
New Cumberland. Kreider, A. R. & Bro.; Finishing Only. (Branch of Annville.)
Pottsville. Boltz, Jacob; 317 N. 9th St.; Women's Extra-size Underwear; 4 sewing machines.	6
Pottsville. Ost & Hay; Mound City Knitting Co.; Water St.; Women's Knit Underwear.	5
Pottsville. Valley Knitting Mills; Givler & Ditzel, props.; 9th and Mine Sts.; Women's Ribbed Vests; 18 sewing machines.	10
Pottsville. Yaissle, John; Women's Knit Underwear; 3 sewing machines.	6
Reading. Redcay & Mell; 763 N. 12th St.; C. F. Redcay, pres.; A. H. Mell, treas. and buyer; Mercerized and Cotton Half Hose; electric; sell direct.
Reading. Spatz, B. H.; Hosiery Mill; 639 Garden St.; \$3,000; B. H. Spatz, pres. and treas.; Cotton Half Hose.	12
Schaefferstown. Houser Hosiery Mills; Chas. Houser, pres. and buyer; Isaac Houser, supt.; Men's and Women's Seamless Hosiery; 2 sewing machines; steam; sell direct in grey.	10
Shoemakersville. Merit Underwear Co.; \$10,000; Benj. M. Bhaer, treas.; E. T. Williams, mgr.; Women's Underwear; 12 sewing machines; buy 12 to 26 combed and carded.	9
Sinking Spring. Model Underwear Co.; R. F. D. 1; N. H. Fichthorn, E. F. Wentworth; Union Suits; 8 sewing machines; steam and electric; sell direct and through agents; buy 30/1 C. P.	5
Tower City. Tower City Knitting Mill; W. J. Henry & Co.; W. J. Henry, supt. and buyer; Ladies' Knit Underwear; electric.
Tower City. Trautman, H. A.; Knitting Mill; Grand Ave.; Women's Underwear; 6 sewing machines.	6
Virginsville. Wanner, Chas. A.; 144-needle Seamless Cotton and Silk Half Hose. (Branch of Fleetwood.)
York Haven. Penn Hosiery Mill; Seamless Half Hose; electric; H. S. Meyer & Co., s. agts.; I. E. Warner, buyer.	20

SOUTH CAROLINA.

Union. The Gault Mfg. Co.; \$10,000; J. H. Gault, pres., treas. and buyer; Men's and Women's Hosiery; dye and finish; steam and electric; B. A. Jacobs & Co., s. agts. (Under construction.)
---	----

TENNESSEE.

Chattanooga. Madeline Hosiery Mills; Ridgedale. (Branch of Davis Hosiery Mills.) (Building new 2-story brick mill, 200 by 64 ft.)	100
Dayton. Dayton Hosiery Mills Co.; \$60,000; J. E. Morgan, treas.; Garnett Andrews, gen. mgr. and buyer. (Plans prepared for 2-story mill, 60 by 122 ft., to be operated by electric power.)
Englewood. Englewood Mfg. Co.; \$50,000; J. W. Chestnut, pres.; T. J. Lillard, sec. and treas.; Hosiery; dye and finish; steam. (Built 2-story mill, 40 by 65 ft.)	48
Lawrenceburg. May Hosiery Mills; Men's Half Hose. (Branch of Nashville.) (New brick mill erected, 80 by 180 ft.)	75
Morristown. Holston Mfg. Co.; Misses' Fine Gauge Hosiery; electric. (Branch of Lenoir City, where goods are finished.) (Built 1-story brick mill, 200 by 60 ft.)	250

Riceville. Riceville Knitting Mills; \$25,000; R. J. Fisher, mgr.; Seamless Hosiery; 30 footers; 30 ribbers; 10 loopers. (Branch of Athens Hosiery Mills, where finishing is done.)
--	----

UTAH.

Salt Lake City. Lloyd Knitting Mills; 30. Richard St.; \$25,000; E. T. Lloyd, pres. and supt.; J. F. Lloyd, treas.; Sweater Coats and Underwear; 12 sewing machines; electric; sell direct.	15
--	----

VERMONT.

Bennington. Bennington Hosiery Co.; \$50,000; Wm. H. Nichols, pres.; Frank B. Pope, treas.; Henry L. Field, mgr. and buyer; Worsted and Merino Half Hose; 5 ribbers; 5 loopers; dye; Graff Bros., s. agts.; buy 1/18 to 1/50 worsted, 1/18 to 1/70 cotton.	20
---	----

WASHINGTON.

Seattle. Octonek Knitting Co.; 425 Union St.; \$30,000; Geo. O. Sanborn, pres. and buyer; J. H. Breese, treas.; A. C. Wilhelm, supt.; Sweaters; buy 2/7, 2/30 and 4/15.
--	----

WISCONSIN.

Brillion. Wisconsin Knitting Mills; Sweater Coats, etc. (Branch of Manitowoc.)
Milwaukee. Imperial Knitting Co.; built 2-story and basement reinforced concrete mill, 60 by 130 ft., at 1071 Third St.
Oconto. Marinette Knitting Mills; Sweater Coats, etc. (Branch of Marinette.)
Whitewater. Bradley Knitting Co.; Finishing Only. (Branch of Delavan.)

CANADA.

Ontario, Alton. Dick, Alex.; Heavy Wool Half Hose.
Ontario, Appleton. Caldwell, Boyd & Co.; established dept. for manufacture of heavy wool hose.
Ontario, Glen Williams. Hinds, Robert; Knit Webbing and Tubing for Glove and Mitt Trade.
Ontario, Hamilton. Mercury Mills, Ltd.; 80 Park St.; \$1,000,000; Men's, Women's and Children's Hosiery, Seamless and Full Fashioned, and Men's Underwear; 100 sewing machines; electric; dye; sell direct.	150
Ontario, Listowel. Perfect-Knit Mills, Ltd.; \$50,000; Max K. Becker, pres., supt. and buyer; Wm. Climie, treas.; Sweater Coats and Knitted Novelties; 11 knitting and 10 sewing machines; electric; sell direct. (Took over Keystone Knitting Co., Georgetown, Ont.)	11
Quebec, Montreal. Regent Knitting Mills, Ltd.; \$200,000; C. G. de Tonnancour, pres.; J. F. Lemieux, treas.; L. Marcoux, supt. and buyer; Men's and Women's Sweaters; 10 sewing machines; buy 2/18 worsted, 8s cotton.	18
Ontario, Orangeville. Dods Knitting Co., Ltd.; Flat and Ribbed Wool Underwear. (Branch of Alton.)
Ontario, Owen Sound. Banks, H. C.; Sweater Coats, Worsted Half Hose and Novelties.
Ontario, Stratford. Williams-Trow Knitting Co.; \$60,000; B. M. Williams, pres. and mgr.; Underwear and Knitted Novelties.
Ontario, Toronto. Allen Brothers; 813 Gerrard St., E.; Infants' Worsted Hosiery, Silk Heel and Toe.	6

NEW SILK MILLS.

Looms

MASSACHUSETTS.

Fall River. Marshall Woven Label Co.; Lowell and Rodman Sts.; John Marshall, pres.; A. E. Carey, treas. and supt.; Silk and Cotton Woven Labels; dye; steam and electric; sell direct and through H. D. Kirk, Chicago.
---	----

NEW JERSEY.

Franklin. Frost & Van Riper; Silk Throwing. (Branch of Paterson.)
Garfield. Paragon Silk Co.; Broad Silks. (Branch of Paterson.)	71

Midland Park. Schofield, Geo. and James; Broad Silks.

Paterson. Farrar, James H., Silk Co.; Ellison St. Extension; Dress and Tie Silks; 640 spindles; sell direct. 34

Paterson. Gerard Silk Mills, Inc.; 181 River St.; \$20,000; Isador Hammer, pres. and supt.; Lester B. Samilow, treas. and buyer; Silk Ribbons; L. B. Samilow Co., s. agt. 15

Paterson. Giant Silk Mfrs., Inc.; Reinhard Mill; \$100,000; Isaac Mendelson, pres.; Jacob Mendelson, treas.; Silk Goods; 220 looms; sell direct; N. Y. office, 117 E. 24th St. 220

Paterson. Graeffelstein & Rosenthal; Pope Mill; Broad Silks. 59

Paterson. Grobart Co.; 18 Paterson St.; \$25,000; Edward Schweser, mgr.; Silk Ribbons.

Paterson. King Silk Co.; Barnet Mill; \$100,000; Max Heyman, mgr.; Silk Goods.

Paterson. Kurkjian, H. H. & Co.; 20 Governor St.; \$50,000; Silk Neckties; Tie Silks and Ribbons.

Paterson. Passaic Falls Throwing Co.; Cooke Mill; \$25,000; Richard Rossiter, treas.; P. Holley, mgr.; Commission Throwing; 7,000 spindles.

Paterson. Peerless Warping & Winding Co.; Mulberry and River Sts.; Commission Warping and Winding; 9 frames.

Paterson. Schottland, Abraham; 25 Ramapo Ave.; Broad Silk Goods; electric; sells direct. 64

Paterson. Shawin & Barbour; 60 Ryle Ave.; Broad Silks. 50

Paterson. Simon, Breen, Magennis Co.; Todd Mill; \$100,000; Joseph Breen, pres., supt. and buyer; F. A. Magennis, treas.; Silk Ribbons; sell direct. 35

Paterson. Taylor-Friedsam Co.; Rosenheim Mill; \$200,000; John G. Taylor, pres.; Morris Friedsam, treas.; Herman Bertschy, supt. and buyer; Silk Ribbons. 50

Paterson. Wide, H. E., Warping & Winding Co.; Slater St. Mills; \$10,000; Commission Winding and Warping.

Phillipsburg. National Warping Co.; 55 Sitgraves St.; Alphonse Iova and Leonard Orcukto, props.; Commission Winding and Warping.

Phillipsburg. Reynolds & Tyrell; Jersey and Sitgraves Sts.; \$50,000; Broad Silks. 18

West New York. Salomon & Newman; built new 2-story mill, 100 by 300 ft., equipped with new machinery. (New York City plant discontinued.)

Wharton. Washington Forge Silk Co.; Benj. W. Mayer, pres.; Jacob A. Widmer, treas., supt. and buyer; Dress and Tie Silks; sell direct. 183

NEW YORK.

Brooklyn. Kahn & Feldman; Bush Terminal Bldg. 20; Silk Throwing; 5,000 spindles.

Brooklyn. Venus Silk Glove Mfg. Co.; Franklin, Hayward and Wallabout Sts.; Silk Gloves. (Branch of Bangor, Pa.) 8

Cortland. Tloughnoga Silk Co.; Silk Throwing.

Gloversville. Normandie Silk Mills, Inc.; \$25,000; Geo. Rowland, pres.; Thos. Hubbard, treas.; L. E. Winnie, supt. and buyer; Glove Silk Cloth; 80 spindles; electric; sell direct. 4

Long Island City. Acorn Silk Co.; occupying new mill at 81 Sunswick St.; New York City plant discontinued. taken over Truth Silk Co., Paterson, and removed here.

Newburgh. Palatine Silk Co.; \$10,000; John Deiseroth, pres. and treas.; F. W. Fulda, supt. and buyer; Dress Silks. 20

Whitestone. Sulzbach, Jacob; built new mill, 150 by 438 ft., one story high.

PENNSYLVANIA.

Philadelphia. Penn Ribbon Mills; Manhattan Silk Co.; 3rd and Ontario Sts.; Silk Ribbons; N. Y. office, 95 Madison Ave. 60

Philadelphia. Rosen, J. & Son; Frankford; Silk Ribbons; steam; Max Rosen, buyer. (Branch of Paterson.) 50

Archbald. Clemens Silk Co.; \$25,000; Benj. Phillips, pres.; Paul Clemens, treas., mgr. and buyer; Broad Silks; electric. (Built 2-story brick mill, 128 by 38 ft.) 58

Hanover. Levy, E. & H.; building new 2-story mill, 150 ft. long, for manufacture of silk ribbons. ..

Kingston. Storms, A. L.; Walnut Ave.; Silk Throwing; 10,000 spindles; steam and electric.

Northampton. Feldhege, H. J., Silk Mfg. Co.; Broad Silks. (Branch of Egypt.)

Northumberland. Susquehanna Silk Mills; building branch mill, 1 story and basement, 148 by 132 ft. (Branch of Sunbury.)

Perkasie. Perkasie Silk Co.; J. H. Frederick; Silk Throwing. (New mill building erected.)

Pittston. Hartley Silk Mfg. Co.; Broad Silks. (Branch of Towanda.) (Built new brick mill, 80 by 200 ft.)

Pottstown. Seltmann, H.; York and Walnut Sts.; Broad Silks; electric; sells thro' agts. 100

Quakertown. Converters Silk Mills, Inc.; Front St.; \$15,000; O. Neuberger, pres.; N. M. Lasker, treas.; L. Mueller, supt.; Throwing and Quilling of Raw Silk; 4,000 spindles; electric; sell direct, 45 Leonard St., N. Y.

Quakertown. Maxwell Ribbon Co.; W. Broad St.; Silk Ribbons.

Reading. Schaeffer & Co.; 126 Carpenter St.; Chas. P. Schaeffer, pres. and buyer; Paul H. Schollenberger, treas.; Victor W. Schaeffer, supt.; Silk, Art. Silk and Mercerized Cotton Shoe Laces; electric; sell direct and thro' Mulford, Cary & Conklin Co.; buy 16/2 to 40/2 and 10/3 merc. and plain cotton.

Scranton. National Silk Throwing Co.; 1015 N. Main Ave.; \$25,000; Jay L. Wolf, pres.; Geo. N. Campbell, treas.; N. P. McTague, supt. and buyer; Silk Throwing; 5,000 spindles; steam.

Scranton. Scranton Silk Co.; E. Baeurle, supt.; Silk Ribbons; electric; sell direct; H. H. Weil, buyer. (See United Ribbon Co., Paterson.) 50

Shamokin. Perfect Silk Throwing Co.; \$35,000; J. E. Kneпка, pres.; W. H. Lee, treas.; Silk Throwing; 10,000 spindles.

Tamaqua. Pennsylvania Silk Spinning Co.; \$10,000; H. O. Jones, pres., supt. and buyer; M. E. Jones, treas.; Commission Throwing; 5,000 spindles; electric.

Warren. Warren Silk Mfg. Co.; \$60,000; Jacob Thissen, supt.; Silk Gloves and Hosiery. (Two-story brick and steel building, 50 by 130 ft., under construction.)

Watson town. Watson town Throwing Co.; \$40,000; Silk Throwing; A. D. Baldwin, supt. and buyer. ..

York. David, B. Edmund; Silk Goods; N. Y. office, 440 Fourth Ave. (Branch of Paterson.) 150

RHODE ISLAND.

Pawtucket. Eastern Silk Winding & Warping Co.; 242 Pine St.; E. Fowler, mgr.; Silk Warps on Commission; 430 spindles; electric.

Phenix. Stoppard, William & Co.; Wm. Stoppard, treas. and buyer; Silk Lace Shawls; electric. (Begin mfg. Jan. 1.)

VIRGINIA.

Culpeper. Culpeper Silk Mills; \$50,000; James Rigby, Jr., pres.; A. L. Goodloe, treas.; Broad Silks; electric; sell direct. 80

Front Royal. Schwarzenbach Huber Co.; Broad Silks. (Branch of West Hoboken, N. J.)

WEST VIRGINIA.

Keyser. Klots Throwing Co.; Commission Silk Throwing. (Branch of Carbondale, Pa.)

MISCELLANEOUS NEW MILLS.

GEORGIA.

Savannah. Floyd Bagging Mills; \$50,000; T. B. Floyd, pres.; M. H. Floyd, treas.; T. B. Floyd, Jr., agt. and buyer; J. V. Shier, supt.; Jute Bagging; 100 spindles; 3 looms; electric; sell direct.

ILLINOIS.

Chicago. Sterling Dye Works; 1800 Ballou St.; Arthur L. Stuart, mgr. and buyer; Dyers of Millinery Goods; steam and electric.

MASSACHUSETTS.

Gleasondale. Standard Brake Lining Co.; A. & C. W. Hanslip, props.; Woven Asbestos Brake Linings and Clutch Facings; 2 looms; dye; electric.

Lowell. Columbia Textile Co.; Percy Gulline, agt.; \$150,000 capital.

Lowell. New England Cable Co.; Howe St.; D. J. McDougal, pres.; Samuel Dunsford, treas. and mgr.

Taunton. Lobsitz, Maurice, Mfg. Co.; Wool and Wool Stock, Garnetted Silks, Noils. (Branch of Phila.) Westboro. Crown Linen Mills; \$50,000; F. A. Gordon, pres.; H. G. Hassall, treas.; Absorbent Linen; dye; steam; Brewer & Co., Worcester, Mass., s. agts.

NEW HAMPSHIRE.

North Salem. New Hampshire Shoddy Co.; Shoddy and Bats. (Occupying part of old Atlas Woolen Mill; installed new machinery and steam power equipment.)

NEW JERSEY.

Montville. Montville Finishing Co.; operating in one of buildings of John Capstick & Sons; erecting brick addition, 125 by 50 ft.
Paterson. Perfection Silk Dyeing Co.; \$20,000; Marino Degrado, Anthony and Henry Nazzaro.

NEW YORK.

Auburn. Auburn Converting Co.; Geo. Underwood, Jr., pres.; W. E. Penny, gen. mgr.; Linen, Cotton and Flax Twines and Tinsel Cord; 200 spindles; dye; electric; sell direct; buy 1 to 24 skeins.
Glenham. Beacon Bleachery; Glenham Embroidery Co.; Bleaching and Finishing of Embroideries; electric.
New York City. Folk Textile Printing Co., Inc.; 117 Spring St.; \$10,000; John Folk, pres.; C. F. J. Laase, treas.; Imitation Embossing of Velvets, Silks, etc.
New York City. Phoenix Asbestos Mfg. Co.; \$10,000; Asbestos Packing; Wm. R. Barrett, Mary E. Tryson and Sidney S. Levine.

NORTH CAROLINA.

Greensboro. Proximity Mfg. Co.; equipped new dyeing and finishing plant, operated by electricity, at cost of \$150,000 to \$200,000, for dyeing and finishing of goods made outside.

PENNSYLVANIA.

Philadelphia. Columbia Silk Dyeing Co.; 1726 N. Howard St.; Dyeing of Real and Art. Silk and Silk Hosiery; capacity, 1,200 lbs. per day.
Philadelphia. Frankford Silk Finishing & Moire Works; Felix Verweken, prop.; Bermuda, between Orthodox St.; Finishers of Broad Silk, Ribbons, etc.
Philadelphia. Novelty Yarn Co.; 110 W. Oxford St.; Thomas Henry, Jr., mgr.; Novelty Yarns; 21 knitting frames.
Philadelphia. Tioga Dye & Finishing Works; Tierney & Carr; 2nd and Diamond Sts.; Dyeing, Finishing

and Packing of Hosiery; capacity, 1,000 doz. per day; Frank Carr, buyer.
Philadelphia. Tomalino & Elliott Silk Dyeing Co.; 4356 N. Gratz St., Nicetown; H. Paul Elliott, treas.; Dyeing of Silk and Art. Silk Skeins.
Allentown. Jordan Silk Dyeing Co.; \$15,000; Wm. A., Edw. F. and August L. Gehringer.
Easton. Easton Silk Dyeing & Finishing Co.; A. J. Keenan, pres. and buyer; Charles Zwald, treas.; Dyeing and Finishing of Silk and Silk Mixed Piece Goods. (Built and equipped new plant.)

RHODE ISLAND.

Pawtucket. Rhode Island Textile Co.; rear 47 East Ave.; \$10,000; Arthur L. Kelley, Jr., pres.; Geo. F. Kelley, treas.; John H. Conrad, mgr. and buyer; Cotton and Silk Braids; 250 braiders; electric; sell direct.
Providence. Windsor Dyeing & Finishing Co.; \$75,000; John Bigbie, William Bowe, Geo. A. Fredenberg and A. J. Carpenter; Converters of Yarns.
Woonsocket. Woonsocket Falls Mill; \$100,000; John Turner, Arthur Robertshaw and Otto Timme. (Bought White Mill and made extensive repairs and improvements. Will probably manufacture pushes.)

TEXAS.

Dallas. Dallas Waste & Bagging Mills; \$300,000; M. H. Thomas, pres.; F. D. Thomas, sec. and treas.; Jute Bagging; capacity, 1 carload per day.

WISCONSIN.

Milwaukee. Wisconsin Mat Co.; 392 Sixth St.; \$10,000; F. A. Escott, pres.; Fred E. Goes, treas.; B. F. Buticofer, supt.; Coco Mats and Matting; 30 looms; electric; sell direct.

CANADA.

Ontario, Cobourg. Cobourg Dyeing Co., Ltd.; \$190,000; Thos. Whiteley, pres.; David C. Dick, vice-pres. and man. dir.; W. M. Hilliard, sec. and treas.; Piece Dyed Woolens, Worsteds, Broadcloths, etc.; capacity 150 pieces per day; water and electric. (Begin operations, May 1914.)
Ontario, Guelph. Canada Flax Mills, Ltd.; built \$100,000 branch plant here. (Main office, Toronto.)
Ontario, St. Catharines. Canadian Flax Mills, Ltd.; Geo. H. Campbell, supt. and buyer; Flax Fibre and Tow Retted; electric. Branch of Toronto. (Expect to build spinning mill in spring.)

Projected Industries

Under this head are enumerated such projects as are now in course of construction, or which in all probability soon will be, but are not sufficiently far advanced to be properly identified in the list of new mills.

COTTON

CALIFORNIA.

Colton. Olympia Cotton Mills; \$1,325,000; M. W. Durham, promoter; Cotton Goods; electric; dye.
Long Beach. Los Angeles Cotton Co., Ltd.; \$750,000; propose to build 10,000-spindle mill; Benj. F. McLouth, A. B. Johnson, Arthur Bridgeman and others interested.

NEW YORK.

Brooklyn. Fulton Bag & Cotton Mills; will erect 8-story factory building and 16-story warehouse, for making up product of mills at Atlanta, beginning spring 1914.
New York City. Robinson, Geo. W.; City Island; to build 2-story mill, 50 by 100 ft., to be equipped with 10 looms for weaving sail duck.
New York City. Sargent, S. B.; Cotton Damasks; 60 looms.

NORTH CAROLINA.

Charlotte. Chas. B. Skipper, John C. Rankin and S. M. Robinson organizing company to build 5,000 spindle cotton yarn mill near here.
Greensboro. Revolution Cotton Mills; enlargements planned to double capacity of plant at cost of \$1,125,000.

OKLAHOMA.

Oklahoma City. Whaley, W. B. Smith; promoting \$10,000,000 cotton mill company with proposed equipment of 600,000 spindles and 15,000 looms.

SOUTH CAROLINA.

Fort Mill. Fort Mill Mfg. Co.; plans prepared for new mill building, 125 by 300 ft., to be equipped with 600 automatic looms.
Graniteville. Graniteville Mfg. Co.; plan to increase capital to \$1,000,000 and add 700 looms.

WOOLEN.

MINNESOTA.

Duluth. Minnesota Woolen Co.; \$20,000; Philip G. Brown, pres.; J. F. Wittenberg, treas.; may build mill for manufacture of all-wool blankets.

OHIO.

Columbus. State Penitentiary; plant for mfr. of blankets and other woolen fabrics to be established.

PENNSYLVANIA.

Philadelphia. Fetterolf, H. G.; to build \$100,000 mill on land purchased at Stenton Ave. and Loudon St., Germantown.

KNIT.

GEORGIA.

Lafayette. Fortune Hosiery Mill; P. D. and A. R. Fortune and J. C. Miller; will build mill; 60 machines.

NEW JERSEY.

Belvidere. Allen, John; bought land and awarded contract for building for hosiery mill.
Newark. Lindner, C. R.; 500 Avon Ave.; Sweaters. (Arranging for equipment.)

PENNSYLVANIA.

Philadelphia. Floor of building at Van Kirk and Erdrich Sts., Wissinoming, being equipped with full fashion machines for manufacture of silk hosiery, neckties, mufflers, etc.
Denver. Fink, Dr. W. D.; considering establishment of plant for manufacture of ladies' cotton ribbed underwear.
Reamstown. Becker, Ray F.; expects soon to start plant for manufacture of seamless hosiery.
Royersford. Progressive Knitting Mills; plans prepared for 4-story mill, 138 by 50 ft.; company to remove from Spring City on completion.
Sunbury. H. A. Boyer and G. E. Trout; establishing hosiery plant to employ about 100 hands.
Tower City. S. D. Bausher and J. B. Leshner; organizing \$30,000 company to build knitting mill here.
Wilkesbarre. Werkheiser, R. C.; planning to establish plant for manufacture of hosiery.

SOUTH CAROLINA.

Columbia. Graham, J. M. & Son; 612 Laurel St.; to establish plant for knitting fine cotton hosiery.

VIRGINIA.

Suffolk. Turner, A. A.; East Suffolk; reported will establish knitting mill.

CANADA.

Alberta, Medicine Hat. H. A. Bonner, of Toronto, planning to establish knitting plant at Red Cliff, a suburb.

MISCELLANEOUS.**NEW JERSEY.**

Camden. Camden Dyeing & Finishing Works; River Ave. below State St.; plans prepared for 46 by 54 ft. dye house and 17 by 32 ft. boiler house.

PENNSYLVANIA.

Hollidaysburg. McCurdy, Samuel; proposes to establish plant for manufacture of crash toweling.

Important Changes COTTON,

ALABAMA.

Bon Air. Danville Knitting Mills; purchased plant of Coosa River Spinning Co. and operating in manufacture of yarns for mills at Danville, Va.
Jacksonville. Verilina Mills; taken over by Profile Cotton Mills; will be operated with new equipment.
Selma. Estelle Cotton Mills; new company operating; S. H. Goodin, pres.; H. H. Stewart, mgr.; extensive improvements made.

CONNECTICUT.

Norwich. Murphy, Wm., Mfg. Co.; Hiscox Bldg.; Wm. H. Murphy, prop.; Geo. McKay, supt.; Cotton Clothes and Fish Lines, Sash Cord, etc. (Formerly Oakdale Cordage Co., Turnerville.)
Putnam. Nightingale-Morse Mills, Inc.; \$800,000; Wm. G. Nightingale, pres.; John K. H. Nightingale, treas.; new company operating Morse, Nightingale and Powhatan mills.

Versailles. Versailles Sanitary Fibre Mills; Hygienic Fibre Co., props.; \$50,000; Chas. A. Kittle, pres.; Benj. W. Cutler, secy. and buyer; Geo. H. Booth, agt.; H. E. Flagler, supt.; Absorbent Cotton, Aseptic Gauze, Sanitary Napkins and Yarns; 7,300 spindles & knitting machines. (New company operating plant of Chas. A. Kittle, formerly Uncasville Mfg. Co.)

GEORGIA.

Griffin. Kincaid Mfg. Co.; purchased Cherokee Mills and increased equipment.
West Point. Lang Cotton Mills; reorganization of Lang Mfg. Co.; A. C. Smith, pres. and buyer; J. Heinzfeld, treas.; W. A. Reed, supt.; electric power equipment installed.

MASSACHUSETTS.

Boston. Atlantic Rope & Line Co.; 47 Field St., Roxbury; R. Delaney, mgr. (Succeeded Norman Mfg. Co.)
Lawrence. Pacific Mills; purchased property and assets of Atlantic Cotton Mills.
New Bedford. New Bedford Textile Co.; purchased and operating plant of Mt. Pleasant Banding Co.
Plympton. Futurity Thread Mfg. Co.; \$100,000; H. C. Bullock, treas.; Cotton Shoe Threads, Commission Twisting and Winding; steam and water; dye. (Succeeded Bullock Thread & Twine Co.)
South Sudbury. Massachusetts Waste Co.; \$99,000; Frank P. Houghton, pres.; J. P. Gillette, treas.; Cleaning Cotton Waste. (Succeeded Am. Cotton Waste Co.)
Worcester. Swananoa Mills, Inc.; 43 Lagrange St.; \$10,000; Thomas Allen, Jr., pres.; Benj. S. Clark, treas. and buyer; Cotton and Silk Narrow Fabrics. (Succeeded L. D. Thayer Mfg. Co.)

MISSISSIPPI.

West Point. Lorraine Cotton Mills; \$125,000; C. E. Wilkins, pres.; J. R. French, treas. and buyer. (New company operating West Point Cotton Mills.)

NEW JERSEY.

Newark. Woodside Mfg. Co.; \$25,000; Edwin C. Sharp, pres.; A. H. Sharp, treas. (Succeeded Kellogg & Sharp Mfg. Co.)
Bessemer City. Huss Mfg. Co.; taken over Osage Mfg. Co.

NORTH CAROLINA.

Chapel Hill. Durham Hosiery Mills No. 7; Cotton Yarns. (Formerly T. F. Lloyd Mfg. Co.)
Cumberland. Necronset Mills; \$400,000; J. Frederic Houston, pres.; Dexter Stevens, vice-pres. and gen. mgr.; Arthur R. Heist, sec. and treas. (Succeeded J. Frederic Houston & Co.)
Fayetteville. Cape Fear Cotton Mills; \$100,000; A. R. McEachern, pres.; Walter McDonald, supt.; new company formed to operate plant of Lakeview Mfg. Co.; extensive repairs being made.
Monroe. Jackson Mills Co.; \$125,000; Cotton Blankets. (Reorganization of Monroe Cotton Mills.)
Taylorsville. Watts Mfg. Co.; weaving dept. discontinued; 6,000 additional spindles installed; will make yarns only.

PENNSYLVANIA.

Philadelphia. Alva Tape Mills; 5th and Columbia Ave.; Thos. McNair, supt. and buyer; 34 looms. (New name for plant of Andrew Michie.)
Philadelphia. American Textile Banding Co.; 3rd and Moore Sts.; \$20,000; Thomas B. Haigh, pres.; M. Jefferson, treas.; Harry Jefferson, supt.; 110 looms; Spindle Banding and Tapes. (Formerly at Methuen, Mass.)
Philadelphia. Fox Chase Mills; Fox Chase; James H. Craig, pres.; E. W. Kelso, treas.; Turkish Towels and Bath Robe Cloth; 60 narrow and 20 wide looms; dye and bleach; steam; sell direct; buy 12 and 14. (Succeed Belmont Mills.)
Philadelphia. Philadelphia Thread Co.; Mascher St. and Lehigh Ave.; D. H. McKinley, mgr.; Glazed Threads and Sewing Cottons. (Equipment of Lansdale Thread Co.)
Philadelphia. Sheerr, Phillip L.; Howard and Palmer Sts.; Hair Cloth; 60 looms; sells direct; buys 1/4, 2/30 warps. (Taken over equipment of Phila. Hair Cloth Co.)
Philadelphia. Strange, Thomas & Sons; Green Lane and Mitchell St.; taken over Empire Bed Spread Mills.
North Wales. Montgomery Mills Co.; \$15,000; F. D. Frissell, pres. and buyer; E. M. Smith, treas.; John Neary, supt. (Operating Montgomery Mills of Russell Mfg. Co.)

RHODE ISLAND.

Pawtucket. Oswegatchie Textile Co.; 96 Broad St.; \$100,000; John T. Kirk, pres.; Fredk. F. Halliday, Jr., treas.; John W. Ramsbottom, agt. and buyer; Wm. Hill, supt.; Ladies' Shawls, Baby Robes and Novelties; 12 looms; electric; sell direct. (Succeeded to business of Wm. Hill.)

SOUTH CAROLINA.

Blacksburg. Broad River Mills; \$50,000; W. C. Hamrick, pres.; D. C. Ross, secy. (New company operating Whittaker Cotton Mill.)

TENNESSEE.

Chattanooga. Aseptic Cotton Products Co.; \$500,000. (Succeeded Southern Aseptic Cotton Co. Capital increased to provide for enlargements and improvements to cost \$250,000.)
Trenton. Lovera Cotton Mills; \$50,000; R. A. Love, pres. (Taken over Trenton Cotton Mills.)

WOOLEN**CALIFORNIA.**

Eureka. Eureka Woolen Mills; F. Carter, gen. mgr.; 3 sets; 40 looms; electric; dye and finish. (Taken over Humboldt Bay Woolen Mills Co.)

MAINE.

Camden. Lincoln Woolen Co.; Chas. I. Lincoln, mgr.; Woolen Goods. (Operated by Parker, Wilder & Co.)
Pittsfield. Smith Textile Co., Inc.; new company succeeding to business of Smith Woolen Co., Fred R. Smith at head.
Skowhegan. American Woolen Co.; taken over former plant of Marston Worsted Co.

MASSACHUSETTS.

Holden. Darling Woolen Mill Co.; taken over and operating old Dawson Mill.
Methuen. Merrimac Valley Mills; Edwin J. Hylan, prop.; Worsted Dress Goods. (New concern operating plant of Tremont Worsted Mills.)
Methuen. Merrimack Mills; Alfred C. Gaunt, prop.; Worsted Goods and Commission Dyeing and Finishing; operating plant formerly occupied by Marshall Worsted Co.
Millbury. Millbury Spinning Co.; C. A. Root, treas.; Worsted Yarns. (Equipment of Brown & Whittier, Lawrence, Mass.)
Webster. Boston Felt & Rubber Co.; \$50,000; Chas. B. Colley, treas.; Henry C. Richardson, supt. (Succeeded Webster Felt & Rubber Co.)

NEW HAMPSHIRE.

Penacook. Brampton Woolen Co.; taken over and operating as a branch old plant of Concord Mfg. Co.

NEW JERSEY.

Gloucester City. Breslin Bros. Co.; \$100,000; taken over and operating plant of Fries-Harley Co.; also absorbed Gothic Wilton Rug and Carpet Co. of Philadelphia.

OHIO.

Ashtabula. Ashtabula Worsted Co.; \$100,000; new company operating Ashtabula Worsted Mills; equipment increased.

PENNSYLVANIA.

Philadelphia. Bunkin & Howard Spinning Mills; Howard and Berks Sts.; \$10,000; Paul Bunkin, pres. and treas.; Edw. T. Howard, mgr.; 5 to 50 Woolen and Merino Knitting and Weaving Yarns. (Operating former plant of Henry Grant.)
Philadelphia. Holliday & Zahn; Burnside St., Manayunk; Woolen and Merino Yarns; taken over plant of Morris & Ott.
Philadelphia. Kelley, Patrick; Ripka Mill, Manayunk; Woolen and Merino Yarns. (Operating former plant of Holliday & Zahn.)
East Brady. Penmomic Co. (Succeeded East Brady Woolen Co.)
Norristown. Woodstock Woolen Co.; \$60,000; W. S. McCarthy, John J. McClosky and Wm. Spink and Wm. R. Taylor. (Taken over Woodstock Mills.)
Reynoldsville. Shapiro, Saml.; Pile Fabrics. (Purchased plant of Greenblatt Textile Co.)

RHODE ISLAND.

Woonsocket. Paragon Worsted Co.; started up old plant on S. Main St.; 26 looms; operated as annex of Providence plant.

WASHINGTON.

Ellensburg. Ellensburg Woolen Mills; \$165,000; J. H. Smithson, pres.; A. C. Spalding, treas. and agt.; A. L. Reid, supt. (Succeeded Washington Woolen Mills Co.)

WISCONSIN.

Onalaska. Western Spinning Mill; Mule Spun Woolen Yarns and Cotton Covered Yarns; 1 to 20

cut; 2 sets; 560 mule and 260 ring spindles; sell direct; D. C. Stickler, buyer. (Operating former branch of Onalaska Woolen Mfg. Co.)

CANADA.

Ontario, Lanark. Caldwell, Boyd & Co., Ltd.; purchased, reequipped and operating plant of W. C. Caldwell Co.

KNIT.**ILLINOIS.**

Chicago. Royal Knitting Mills; bought Winchester Knitting Mills; increasing equipment to 72 knitting and 54 sewing machines.

MASSACHUSETTS.

Reading. Middlesex Knitting Co., Inc.; occupying new quarters in Black's Block, with additional space, which will be utilized for increased equipment.

MICHIGAN.

Burr Oak. Adrian Knitting Co.; purchased plant of Whitehouse Underwear Co., to be operated as branch of Adrian.

NEW JERSEY.

Morristown. Common Sense Suspender Co.; \$200,000; Fred Muchmore, pres.; J. L. Talmadge, treas.; John E. Dakin, supt. and buyer; Seamless and Full Fashioned Hosiery; taken over plant of John C. Dakin, New Brunswick.

NEW YORK.

Cohoes. Anchor Knitting Mills Co., Inc.; \$50,000; C. R. North, pres. and mgr.; C. F. North, treas. (Succeeds to business of Anchor Knitting Mills of Chas. F. North.)
Cohoes. Hope Knitting Co.; operating former plant of Parsons Mfg. Co. as branch.
Elmira. Campbell Knitting Mill Co.; reorganized with following officers: John F. Heffernan, pres.; A. J. Armstrong, vice-pres. and selling agt.; B. J. Heffernan, sec. and buyer; W. S. C. Wiley, supt.
Glendale. Ascher, Simon & Co.; Bishops Securities, Inc.; Loft Bldg., Dry Harbor Road, new address; operating 100 knitting and 25 sewing machines.
Mohawk. Elastic Spring Knit Corp.; \$250,000; Walderma C. Schaufier, pres. and buyer; W. J. Reincke, treas.; F. L. Riehr, supt.; Wool and Worsted Union and Two Piece Ribbed Underwear for Men, Women and Children; 8 sets cards; dye (yarn and piece); steam and electric; Clift & Goodrich, N. Y., s. agts.
Parish. Parish Knitting Co.; \$20,000; Wm. Gee, Wm. H. Spanswick and Albert R. Jennings. (Taken over branch plant of Wm. H. Spanswick Mfg. Co.)
Valatie. Standard Mfg. Co.; E. S. Sanborn, supt.; Sweater Coats; 4 sets; 26 knitting machines; 24 sewing machines; steam; Hecht & Campe, N. Y., s. agts.; John A. Nuttall, buyer. (Operating in former plant of Valatie Knitting Co.)

NORTH CAROLINA.

Marion. Carolina Hosiery Mills; J. G. Berry, supt.; J. W. Streetman, buyer; Ladies' Hosiery. (Former plant of Mt. Ida Hosiery Mill.)
Penrose. Calhoun Hosiery Co.; \$125,000 (authorized); J. G. Scrutchin, Jr., pres. and treas. (Company organized to take over former hosiery knitting plant of Penrose Mfg. Co.)
Raleigh. Watkins Hosiery Co.; Belmont St.; new location; removed here from Wake Forest.

NORTH DAKOTA.

Fargo. Fargo Knitting Mills Co.; M. E. Linke, mgr. (Succeeded Red River Knitting Mills.) (Increasing equipment.)

OHIO.

Columbus. Columbus Knitting & Mfg. Co.; new company organized to succeed W. H. Phelps Co.
Piqua. Imperial Underwear Co.; \$150,000; A. D. Hance, pres.; C. E. Stuart, treas. and buyer; absorbed Stuart-Hance Underwear Co.
Portsmouth. Mitchell Mfg. Co.; \$100,000; John E. Williams, pres.; C. E. Dowling, treas.; C. M. Mitchell, mgr. and buyer; J. C. Scott, supt.; Men's Medium Grade Union Suits; 20 knitting machines; 75 sewing machines. (Taken over former plant of Scott Knitting Co.)

Tippecanoe City. Superior Underwear Co.; Finishing only; 50 sewing machines; branch of Piqua. (Former plant of Tippecanoe Underwear Co.)

PENNSYLVANIA.

Philadelphia. Alberts, Carl; Front St. and Lehigh Ave. (Taken over and operating plant of Scotland Mills Hosiery Co.)
 Philadelphia. Eagle Hosiery Mills; Chas. Ackerman, prop.; 110 Turner St. (Formerly Bridesburg Hosiery Mills Co.)
 Philadelphia. Schorr Knitting Co.; 334 Market St.; Silk Knit Neckwear. (Succeeded Majestic Knitting Mills.)
 Philadelphia. Wear-Best Knitting Co.; Jasper St., below Orleans; new address and new name for Watt & Beck Hosiery Co.
 Bridgeport. Bridgeport Knitting Mills, Inc.; \$50,000; Jos. S. Rambo, pres.; H. K. Regan, treas. (New company operating Kaufman Knitting Mill.)
 Gibraltar. Lando, W. H.; Fine Gauge Mercerized Half Hose; 35 knitting machines. (Formerly at Reading.)
 Hamburg. Clover Underwear & Bleach Works; J. Edw. Miller, Oliver A. Law and George A. Zook. (Formerly Gotham Underwear Mill No. 2.)
 Huntingdon. Huntingdon Hosiery Mills; C. J. Speck, mgr.; Half Hose; 40 knitting machines. (Former plant of H. E. Funk combined with that of C. J. Speck of Mill Creek.)
 Kutztown. Deisher Knitting Mills; \$100,000; H. K. Deisher, pres., supt. and buyer; Philip D. Hoch, treas. (Incorporation of business of H. K. Deisher; equipment increased.)
 Pottsville. Hock, John, Knitting Mills; \$10,000. (New company operating Anthracite Knitting Mill.)
 South Bethlehem. Hall Hosiery Co.; 947 Broadway; F. C. Christman, supt.; Men's, Women's and Children's Hosiery. (Taken over South Bethlehem Ktg. Mills.)
 Towanda. Allensville Hosiery Mills; Vance A. Zerby, pres.; Harry L. Hubbs, treas. (Merger of Allensville Hosiery Mills of McVeytown and Towanda Mfg. Co.)

RHODE ISLAND.

Coventry Centre. Rhode Island Hosiery Co.; Jas. H. Hill & Sons, props.; Saml. Youde, supt.; Lisle, Mercerized and Silk Hosiery. (Formerly at Providence.)

TENNESSEE.

South Pittsburg. Aycock Hosiery Mills; \$100,000; R. C. Aycock, pres., treas. and buyer; W. E. Catron, supt.; reorganized. (Building new dye house and finishing dept.)

VERMONT.

Bennington. E. Z. Waist Co.; purchased and operating in former plant of Vermont Hosiery Co.

SILK.

CONNECTICUT.

Mystic. Mystic Silk Co.; \$10,000; M. A. Kleinberger, pres. and treas.; J. B. Faisant, supt. (New company operating Ninigret Mills; equipment increased.)

Norwich. West Side Silk Mill; Schwarzenbach, Huber Co.; M. L. Bergstresser, supt.; Broad Silks; 167 looms; steam. (Former plant of Rogers, Thompson, Givernaud Co.)

NEW HAMPSHIRE.

Allenstown. Suncook Artistic Webbing Co.; School St.; \$10,000; Jenness S. Dearborn, pres.; George F. Georgi, treas.; Emil Zinn, supt. and buyer; Narrow Silks, Insertions, Trimmings and Edgings; 11 looms; electric; sell direct.

NEW JERSEY.

Alpha. Alpha Silk Throwing Co.; \$25,000; G. A. Roeth, Raymond Blum and Clarence Walters. (Organized to take over Alpha Silk Co.'s plant.)

Homestead. Atlas Finishing Co.; \$50,000; E. Gerli & Co. (Operating plant of Rogers, Thompson, Givernaud Co.)

Paterson. Klein & Levy; 40 Lawrence St.; Broad Silks; 24 looms. (Formerly S. Klein & Sons.)

Paterson. Krachman & Margolis; Bridge and River Sts.; Broad Silks, 36-in. Goods; 20 looms; sell direct. (Succeeded Fidelity Silk Co.)

Plainfield. Jersey Silk Mill. (New company operating plant of Mitchell-Watching Silk Co., with increased equipment.)

West Hoboken. Migel, M. C. & Co.; David Ross, supt. (Operating old Rogers, Thompson, Givernaud plant.)

NEW YORK.

New Berlin. Kidney, Richard S.; prop. of Auburn Silk Mill. (Taken over and operating plant of New Berlin Silk Mfg. Co.)

Oneida. Heminway, M. & Sons Silk Co.; purchased and operating silk dept. of Oneida Community, Ltd. Theresa. Lincoln Silk Co. of Paterson. (Taken over and operating Theresa Silk Mill.)

PENNSYLVANIA.

Berwick. Muster Company; \$15,000; Fred Muster, pres., supt. and buyer; Ernest Muster, treas.; Thrown Silk; 6,000 spindles. (Took over Tamaqua Silk Throwing Mills.)

Chambersburg. Piedmont Silk Co., Inc.; \$35,000; Henry T. Fleitmann and H. B. Stanford. (New company operating former branch of Cedar Cliff Silk Co.)

Coatesville. Ashley & Bailey Co.; plant purchased by S. J. Aronsohn, Inc., Paterson. To be continued in operation.

Dushore. Mason Silk Mills; operating 120 looms in former plant of Loyal Sock Silk Co.

Emaus. Emaus Silk Co.; \$50,000; J. H. Frederick, pres. and buyer; Broad Silks; 250 looms; I. A. Bardenheuer, N. Y., s. agt. (New company occupying plant of Keystone Silk Mills.)

Forest City. Dery, D. G.; Silk Throwing; 10,000 spindles; main office, Allentown. (Taken over plant of Alfred Harvey Silk Co.)

Hawley. Realty Weaving & Spinning Co.; \$100,000. (Takes over Belmont Silk Mills.)

Marietta. Dery, D. G.; purchased plant of Ashley & Bailey; replacing old looms with new equipment.

Parsons. Leon-Ferenbach Silk Co.; Parsons Branch; Geo. G. Tillotson, mgr. (Formerly Parsons Silk Throwing Co.)

Reading. Haledon Throwing Co.; Silk Throwing; branch of Paterson. (Taken over throwing dept. of Berkshire Silk Mill.)

Reading. Lion Silk Mills; H. I. Felberbaum, prop.; N. Y. office, 111 Fifth Ave. (Occupying part of Berkshire Silk Mill.)

Reading. Schuylkill Silk Mills; occupying new mill; added 10 Milanese lace machines and lace warping mills. (Succeeded Reading Glove & Mitten Co.)

Ridgeway. Holmes Silk Co.; Broad Silks; 40 looms. (Taken over Ridgeway Silk Mill.)

Taylor. Expert Silk Co.; Geo. and David Kaufman, props.; Broad Silks. (Removed from Paterson and occupying plant of Taylor Worsted Co.)

VIRGINIA.

Charlottesville. Charlottesville Silk Mills; \$75,000 (authorized); E. C. Rolker, pres. and buyer; Joseph P. Ryan, treas.; Bolt Silk Goods; 42 looms; electric; Rolker & Murphy, N. Y., s. agts. (Taken over Philipsburg, N. J., Silk Co.)

MISCELLANEOUS.

NEW HAMPSHIRE.

North Salem. Emmons, H. I., Co.; Dyeing, Bleaching and Cleaning of Waste. (Formerly at Methuen, Mass.)

NEW JERSEY.

Paterson. Kaufman Silk Dyeing Co.; \$30,000. (New company formed to take over plant of Schetty Silk Dyeing Co., 188 Putnam St.)

Waldwick. Waldwick Bleachery; \$100,000. (New company organized to take over Ramapo Bleachery.)

PENNSYLVANIA.

Towanda. Schetty Bros. Co. (Succeeded Schetty Silk Dyeing & Finishing Co. and removed here from Paterson. Adding dept. for dyeing of blacks.)

RHODE ISLAND.

Pawtucket. Le Bon Bleach & Dye Works; 1115 Central Ave.; John Kinniburgh, supt.; Bleaching and Dyeing of Cotton Yarns and Narrow Fabrics, Knit Goods, Rubber Linings and Astrachans, also Artificial Silk; steam and water; Matthew Kinniburgh, buyer. (Formerly Pawtucket Dyeing & Bleaching Co.)

Enlargements and Improvements

COTTON.

ALABAMA.

Athens. Fulton Cotton Mill Co.; (a reorganization of the Athens Cotton Mill Co.); built new brick weaving mill, 125 by 152 ft., for manufacture of ducks and drills; installed 129 looms.
Alexander City. Russell Mfg. Co.; installed 6,000 additional spindles and electric drive equipment; built addition to house this increase.
Birmingham. Avondale Mills; about \$50,000 expended for new equipment, including 20,000 spindles and carding machinery.

CONNECTICUT.

East Killingly. International Cotton Mfg. Co.; built new bleachery and storehouse and installed 8 new cards and other machinery.
Killingly. Killingly Mfg. Co.; control purchased by interests connected with Goodyear Tire & Rubber Co.; built addition and installed new machinery for manufacture of tire fabrics.

GEORGIA.

Atlanta. Exposition Cotton Mills; capital increased \$200,000; installed 5,000 additional spindles and 400 looms to replace old ones.
Eatonton. Imperial Cotton Mills; built 2-story addition, 180 by 75 ft., and added 6,200 spindles and 160 looms, doubling capacity.
La Grange. Dixie Cotton Mills; built new 2-story mill, 109 by 196 ft., at cost of \$100,000; using electric power in both old and new plants; added 13,000 spindles.
Macon. Bibb Mfg. Co.; built new 2-story brick and concrete mill, 350 by 75 ft., with electric power equipment; added 18,000 spindles.
Manchester. Manchester Cotton Mill; building 2-story brick addition; will add 5,000 spindles.

MASSACHUSETTS.

Adams. Renfrew Mfg. Co.; built new weave shed of 150 looms, new yarn storehouse, 175 by 200 ft., 2 stories high, and new bleach house, 70 by 140 ft.
Chicopee. Dwight Mfg. Co.; old No. 3 mill torn down and replaced with modern building.
Easthampton. Glendale Elastic Fabrics Co.; capital increased by issue of \$197,700 new stock and business of Nashawannuck Mfg. Co. taken over; now installing 88 motors for electric drive.
Fall River. Fall River Iron Works Co.; installed 1,050 new automatic looms to replace old narrow looms.
Fishersville. Fisher Mfg. Co.; installed 300 new fancy looms; equipped carding and spinning departments in new addition.
Stoughton. Wood, J. W., Elastic Web Co.; built 1-story addition, 60 by 80 ft., for weaving dept.
West Warren. Warren Cotton Mills; completing large new weave shed; equipping with electric motors and humidifying and air-cleaning systems.

NORTH CAROLINA.

East Durham. Durham Cotton Mfg. Co.; built new dye house, 78 by 132 ft., and installed 1,400 additional spindles.
Gastonia. Clara Mfg. Co.; built addition, 75 by 160 ft., and installed 3,700 spindles and accompanying machinery.
Gastonia. Ozark Cotton Mills; building 3-story addition, 100 by 75 ft., to double capacity; 10,000 spindles to be added.
Greensboro. Pomona Mills, Inc.; added 5,000 spindles and accompanying equipment.
High Point. Pickett Cotton Mills; installed two additional spinning frames and 12 automatic looms; considering increase to 30,000 spindles and 750 looms.
Huntersville. Anchor Mills; built additions, 150 by 75 ft. and 50 by 25 ft. and installed 5,000 spindles.
Kinston. Caswell Cotton Mills, Inc.; built 100-ft., 2-story extension to mill and installed 5,400 spindles, doubling capacity.
Lawndale. Cleveland Mill & Power Co.; built new dye house, 180 by 35 ft.; also extension to mill, 60 by 40 ft. and addition 40 by 50 ft. for twisting and winding.

Lexington. Dacotah Cotton Mills; 3-story addition under construction, to be equipped with 4,800 spindles and 150 looms.
Kannapolis. Cannon Mfg. Co.; built 120-ft. addition to weave room.
Roanoke Rapids. Roanoke Mills; added 4 napping machines and 256 new automatic looms.
Salisbury. Salisbury Cotton Mills; built 2-story brick addition; new machinery equipment to be installed.
Selma. Ethel Cotton Mills; expending \$70,000 for new equipment, including 3,000 spindles.
Swepsonville. Virginia Cotton Mills; installed 570 motors and other equipment for individual electric drive.

PENNSYLVANIA.

Philadelphia. Baxter, Kelly & Faust, Inc.; plans prepared for new mill building, 195 by 60 ft., 4 stories, brick construction, to be equipped with sprinkler system and electric power.
Philadelphia. Lindley Mfg. Co.; Indiana Ave. and A St.; installed 12 broad looms for manufacture of cotton bed spreads.
Cliff Heights. Kershaw, Nelson; built new 3-story weaving mill, 50 by 150 ft.
Reading. Narrow Fabric Co.; erected new steel and concrete factory building, 4 stories high.

RHODE ISLAND.

Georgiaville. Bernon Mills; installed 6,000 additional spindles.
Hope Valley. Taylor, J. J. & Co.; built addition 54 by 54 ft., and installed 26 new looms.
Pawtucket. Hope Webbing Co.; three enlargements erected, one of three stories, 172 by 42 ft., an eil, 99 by 42 ft., and a power house, 44 by 80.

SOUTH CAROLINA.

Anderson. Conneross Yarn Mill; built 2-story addition, 50 by 100 ft., and started new cotton waste dept.
Anderson. Cox Mfg. Co.; plant purchased by Wellington, Sears & Co., Boston, and being reequipped to manufacture duck at cost of \$200,000, according to report.
Chester. Eureka Cotton Mills; built addition, 125 by 40 ft., and added 2,500 spindles and 100 looms, new equipment.
Columbia. Southern Aseptic Laboratories; rebuilt burned plant, with increased space and machinery.
Greenville. Woodside Cotton Mills; completed installation of 27,000 additional spindles and 678 looms, with large amount of electric power equipment.
Greenville. Camperdown Mills; built 1-story brick addition, 105 by 28 ft., and installed 40 new looms.
Greenwood. Panola Cotton Mills; added 5,300 spindles and 125 automatic looms.
Lancaster. Lancaster Cotton Mills; capital increased from \$1,000,000 to \$2,500,000; large additions to plant, equipped with electric drive.
Pacolet. Pacolet Mfg. Co.; added 6,592 spindles and accompanying machinery.
Piedmont. Piedmont Mfg. Co.; built new cloth room, 70 by 177 ft.; replaced old equipment with new machinery and installed 1,200 h. p. turbine and electric drive equipment.
Yorkville. Cannon & Co.; built addition, 75 by 300 ft.; installed 200 new looms and changed from steam to electric power. (Formerly York Cotton Mills.)

TENNESSEE.

Knoxville. Brookside Mills; capital increased from \$900,000 to \$1,200,000; added 15,000 spindles and 559 looms.

WISCONSIN.

Baraboo. McArthur, Geo. & Sons; building new concrete mill, 80 by 40 ft.

WOOLEN.

CONNECTICUT.

Bridgeport. Salt's Textile Mfg. Co.; built new 3-story mill, new 1-story weave shed, new dye house and power house, all of brick, steel and concrete construction.

Coscob. Mianus Mfg. Co.; built 4-story addition, 40 by 60 ft. and added 2 sets and 12 broad looms.
 Mystic. Mystic Woolen Co.; erected modern brick building for wet finishing and dyeing departments and installed additional looms.
 Rockville. Regan, Jas. J., Mfg. Co.; built 2-story brick addition, 70 by 100 ft. (Purchased Saxony Mill of Hockanum Co.)
 Stafford. Phoenix Woolen Co.; built 50-foot addition full size of main mill; added looms.

INDIANA.

La Porte. La Porte Woolen Mills; erected new building, 50 by 65 ft., for power plant; increased capacity of yarn dept. 25 per cent.

MASSACHUSETTS.

Caryville. Taft Woolen Co.; built addition to carding department and installed electric drive equipment.
 Clinton. Bigelow Carpet Co.; building new 3-story brick mill, 133 by 77 ft., to replace old wool house, to be equipped largely with new machinery.
 Franklin. Franklin Yarn Co.; built brick addition, 110 by 70 ft., for card room.
 Haverhill. Emmons Bros. Co.; added 7 sets of cards.
 Holliston. Darling Woolen Mill Co.; built 40-foot addition and installed 8 new looms.
 Medway. Fabyan Woolen Co.; building 3-story brick mill, 33 by 53 ft., to increase weaving dept., 14 looms to be added.
 Mendon. Whiting, Geo. R.; Mendon Woolen Mills; built and equipped new plant to replace one burned.
 Rochdale. Clark, J. D., Co.; built 1-story addition, 20 by 36 ft., and installed 8 additional looms.
 Webster. Slater, S. & Sons; built additions and increased equipment.

MICHIGAN.

Clinton. Clinton Woolen Mfg. Co.; added 1 set cards, 576 spindles and 5 looms.

NEW HAMPSHIRE.

Franklin. Franklin Mills; added another story to No. 2 Mill, 122 by 44 ft., increased space to be used for dry finishing.
 Guild. Granite State Mills; built new weave shed, 110 by 33 ft., and installed 24 looms, equipped with individual motors.
 Tilton. Carter, A. D.; built 3-story addition and added 10 looms to equipment.
 Tilton. Tilton Mills; built addition and ordered 40 additional looms.

NEW YORK.

Amsterdam. Sanford, Stephen & Sons, Inc.; made extensive improvements, including 5-story building for dyeing dept.
 Amsterdam. McCleary, Wallin & Crouse, Inc.; capital increased from \$2,000,000 to \$4,000,000 to provide for 50 per cent. increase in production.

OREGON.

Eugene. Eugene Woolen Mill; installed new wool washing and drying equipment.
 Portland. Portland Woolen Mills; built brick and concrete mill, 200 by 80 ft., doubling capacity.

PENNSYLVANIA.

Philadelphia. Alva Carpet & Rug Co.; built 2-story addition, 65 by 100 ft.
 Philadelphia. Baker, A. T. & Co.; plans prepared for new 4-story reinforced concrete building, 70 by 200 ft., on Main St. Manayunk
 Philadelphia. Cambridge Worsted Co.; increased space and added 10 new looms.
 Philadelphia. Delaine Mills, Inc.; installed 26 new looms and new finishing equipment.
 Philadelphia. Masland, C. H. & Sons; built 5-story-and-basement addition, 65 by 100 ft.
 Philadelphia. Superior Textile Mills, Inc.; installed 10 new broad looms for making astrachans and department for custom burling and mending.
 Bloomsburg. Magee Carpet Co.; installed 40 looms in new weaving dept.
 Honesdale. Birdsall Bros.; built 2-story additions, 21 by 40 ft., and installed 10 new looms.
 Lenni Mills. Yorkshire Worsted Mills; built brick addition, 52 by 100 ft., for weaving and finishing.
 Reading. Leinbach, J. G., Co.; added 3 sets cards and 40 looms; steam power plant reequipped and enlarged.

RHODE ISLAND.

Bristol. Cranston Worsted Mills; built brick addition, 46 by 65 ft., 4 stories high.
 Harrisville. Stillwater Worsted Co.; built 2-story brick addition, 100 by 60 ft.
 Woonsocket. Samoset Worsted Mills; building addition, 88 by 115 ft., and will install 2,400 additional spindles.
 Woonsocket. Guerin Spinning Co.; built frame addition, 72 by 156 ft., one and two stories.

VERMONT.

Bennington. Holden-Leonard Co.; built addition to finishing dept., 72 by 52 ft.

VIRGINIA.

Bedford City. Bedford Mills Co.; built addition and installed 4 new sets of cards and 4 mules.

WEST VIRGINIA.

Barnesville. Barnesville Mfg. Co.; built brick and concrete addition, 100 by 65 ft., and added 2 sets and 8 looms.

WISCONSIN.

Chippewa Falls. Chippewa Falls Woolen Mill; built 3-story and basement addition, 35 by 60 ft., for dyeing and scouring.
 West Bend. West Bend Woolen Mills; added equipment to increase capacity 100 per cent.

CANADA.

Ontario, Almonte. Thoburn, William; additions to plant include 2 sets and 7 looms.
 Ontario, Chatham. Taylor, T. H., Co.; built addition 76 by 50 ft., and added 11 looms.

KNIT.**CALIFORNIA.**

San Francisco. Gantner & Mattern Co.; built new 5-story reinforced concrete factory building at Mission and 10th Sts., containing 80,000 ft. of floor space and increasing capacity 100 per cent.

GEORGIA.

Barnesville. Collier Mfg. Co.; doubled capacity of knitting, bleaching and finishing departments and installed electric power equipment; built 2-story addition, 150 by 50 ft.
 Lafayette. Walker County Hosiery Mills; installed 115 additional knitting machines.
 Rome. Rome Hosiery Mills; built brick addition, 64 by 120 ft., 2 stories high, to be equipped with 100 knitting machines; dyeing and finishing departments increased.

ILLINOIS.

Champaign. Textile Mfg. Co.; built new mill, 2 stories, 210 by 50 ft., to take place of plant burned.
 Rockford. Burson Knitting Co.; built 4-story modern mill to replace old building.

IOWA.

Atlantic. Atlantic Knitting Co.; built addition and installed 6 new knitting machines, 2 automatic sleeveless and 2 body machines.

MASSACHUSETTS.

Chicopee Falls. Taylor, Bramley Co.; erected new 4-story building, 75 by 30 ft., and equipped with new knitting and other machinery.
 Lowell. Ipswich Mills; taken over hosiery department of Middlesex Co. and installed 125 additional machines.

MICHIGAN.

Adrian. Adrian Knitting Co.; additions to plant consisting of three buildings, 43 by 80 ft., 29 by 50 ft. and 54 by 111 ft.

MINNESOTA.

Minneapolis. Northwestern Knitting Co.; capital increased to \$3,000,000 and extensive additions to plant made.

NEW HAMPSHIRE.

Laconia. Pitman Mfg. Co.; built addition and installed 20 new knitting machines.

NEW JERSEY.

Beverly. Beverly Underwear Co.; built addition and installed equipment doubling capacity.
 Vineland. Karl, John; added 70 knitting machines to equipment.

NEW YORK.

Broadalbin. Broadalbin Knitting Co.; building addition, 60 by 70 ft., 3 stories high; 3 sets of cards and knitting machines to be added to increase production 50 per cent.

Brooklyn. Kayser, Julius & Co.; built new 7-story concrete mill, 110 by 268 ft.

Clinton. Clinton Knitting Co.; built addition and installed 6 new knitting frames.

Greenwich. Palmer, Jesse V., Co.; extensive improvements to plant include erection of new bleach house.

New Hartford. Olympian Knit Goods Co.; building addition, 154 by 50 ft., 4 stories high, also new boiler and engine house, 35 by 47 ft., to be completed before Jan. 1.

Valatie. Adhesive Gimp Mfg. Co.; added 10 knitting machines, equipped new finishing room and capacity increased to 200 doz. sweater coats per day.

Watertown. Shaughnessy Knitting Co.; added new knitting machines and largely increased output.

NORTH CAROLINA.

Burlington. Whitehead Hosiery Mills, Inc.; capital increased to \$100,000; built new 3-story mill, 160 by 50 ft., and equipped with 200 knitting machines, 45 ribbers and 35 loopers.

Durham. Durham Hosiery Mills No. 2; built new mill, 263 by 100 ft., also smaller addition, 80 by 40 ft., doubling capacity; 200 machines added.

High Point. Piedmont Mills Co.; erecting building for hosiery mill with capacity of 1,000 doz. per day.

Statesville. Bradford Knitting Mill, Inc.; added 50 new knitting machines and installed electric drive to replace steam power plant.

OHIO.

Bowling Green. Monarch Underwear Co.; capital increased to \$50,000; built new warehouse and installed new knitting and sewing machines.

Cleveland. Fashion Knitting Co.; capital increased from \$10,000 to \$50,000 and additional machinery installed.

Piqua. Piqua Hosiery Co.; capital increased from \$75,000 to \$150,000; added 10 new knitting and 22 new sewing machines.

Toledo. Dolphin Hosiery Co.; occupying new quarters; capital increased to \$75,000; added 35 knitting machines and dyeing and finishing machinery.

PENNSYLVANIA.

Philadelphia. Allen Knitting Mills Co.; 11th and Westmoreland Sts.; new address; added machinery to double production.

Philadelphia. Miller & Sons Co.; built 2-story addition, 100 by 156 ft., also dye house, 50 by 56 ft.

Philadelphia. Rosenau & Loeb; installed 30 new knitting machines; planning to establish branch in Frankford.

Boyetown. Crescent Knitting Mills; built addition, 32 by 60 ft., and increased equipment.

Grill. Grill Hosiery Mills; added 20 knitting machines and installed new dyeing equipment.

Harrisburg. Moorhead Knitting Co.; Cameron and Walnut Sts.; capital increased to \$100,000 and new mill erected, 4 stories, 50 by 140 ft.

Honesdale. American Knitting Co.; built 3-story brick addition, 75 by 125 ft., increasing production 50 per cent.

Pittston. Alpine Knitting Mills; built addition, 70 by 58 ft., increasing production to 500 doz. daily.

Quakertown. Quakertown Knitting Mills Co.; installed 21 new knitting machines and piece dyeing equipment.

Reading. Leininger & Eberly; Oakbrook Hosiery Co.; built new brick mill to replace burned plant, doubling capacity.

Reamstown. Hope Hosiery Co.; building new 3-story brick mill, 28 by 78 ft.; will install electric power equipment and about 35 new knitting machines.

York. Acme Hosiery Co.; built 2-story brick mill, 36 by 100 ft.

RHODE ISLAND.

Pawtucket. Lumb Knitting Co.; built addition, 100 by 100 ft.

Pawtucket. Pawtucket Hosiery Co.; built new brick mill, 100 by 100 ft., and increased equipment to 180 knitting machines.

Providence. Roseknit Hosiery Co., Inc.; incorporated with capital of \$20,000; James Dunlop, Jr., pres.;

Frank L. Rosenfield, treas. and buyer; increasing equipment to give production of 1,000 doz. per week.

TENNESSEE.

Clinton. Magnet Knitting Mills; increased capital to \$75,000 and added 25 new knitting machines.

Knoxville. Knoxville Knitting Mills Co.; capital increased from \$100,000 to \$300,000 and new bleach house erected with larger capacity than one burned.

WEST VIRGINIA.

Martinsburg. Interwoven Mills, Inc.; built brick addition to dye house, increasing dept. 50 per cent., also 4-story building, 56 by 136 ft., for storage and packing.

WISCONSIN.

Kenosha. Kenosha Knitting Co.; capital increased to \$30,000; built 3-story brick mill, 36 by 100 ft., doubling capacity.

Merrill. Merrill Knitting Co.; capital increased to \$30,000; built 3-story brick mill, 40 by 75 ft.

Milwaukee. Van Dyke Knitting Co.; building new 4-story mill, 100 by 150 ft., to cost \$60,000 and double capacity.

CANADA.

Ontario, Amherstburg. Hamilton & Lewitt Knitting Co., Ltd.; built 3-story addition, doubling capacity, and took over equipment operated by Hall-Hatch Knitting Co. on wool socks.

Quebec, Montreal. Dominion Cord & Tassel Co.; 505 St. Paul St.; Automobile Scarfs; 6 sewing machines. (New dept.)

Quebec, Shawinigan Falls. Shawinigan Knitting Co., Ltd.; capital increased to \$200,000 and 11 knitting and 22 sewing machines added.

Ontario, Toronto. Reliance Knitting Co., Ltd., makers of sweaters and fancy knit goods; installed dept. for manufacture of men's two-piece and union underwear.

MISCELLANEOUS.**MASSACHUSETTS.**

Lowell. Lowell Bleachery; building \$20,000 brick and concrete addition.

Ludlow. Ludlow Mfg. Associates; built new 5-story mill, also 6-story structure connecting Mills 10 and 11; contract let for new storehouse to cost \$100,000; additions made to steam power plant.

Webster. Stevens Linen Works; built 2-story brick addition, 70 by 290 ft.; installed new automatic looms and electric drive equipment.

MINNESOTA.

Duluth. Western Rug Co.; building new plant, two buildings, 146 by 86 ft. and 146 by 60 ft., one and three stories, of concrete construction.

Minneapolis. Crex Carpet Co.; building \$1,000,000 group of concrete buildings, including 5-story factory 75 by 500 ft., two warehouses 102 by 512 ft., machine shop 100 by 100 ft., and power plant 50 by 125 ft.

MISSOURI.

St. Louis. Lowell Bleachery; capacity of experimental plant increased to 60,000 lbs. per week; may build on land purchased.

NEW YORK.

Niagara Falls. Niagara Falls Linen Co.; built addition to be equipped with 100 additional looms.

PENNSYLVANIA.

Philadelphia. Hellwig Silk Dyeing Co.; building new \$250,000 plant at Milner, Howell and Homestead Sts. and Delaware River.

Marcus Hook. American Viscose Co.; plans prepared for three new buildings, one 135 by 423 ft., two stories and basement, one 78 by 152 ft., five stories high, and one 117 by 173.

RHODE ISLAND.

Apponaug. Apponaug Co.; \$800,000; Edw. C. Dubois, pres.; Wm. O. Gay, treas.; Alfred L. Lustig, gen. mgr.; Wm. P. Wright, res. mgr.; company reorganized and machinery for handling new lines installed.

Phillipsdale. Glenlyon Dye Works; built addition, 100 by 40 ft., one and two stories, of heavy steel and brick construction.

Correspondence and Notes

UPON TEXTILE TOPICS AT HOME AND ABROAD

ARTIFICIAL SILK IN THE FORM OF LOOSE FIBERS

BY ROBERT DANTZER

Translated from the French by the Editor of the Textile
World Record

Artificial silk has been manufactured almost wholly in the form of continuous filaments, which have been doubled to obtain a thread of the desired size or weight, this being similar to the process of reeling and doubling natural silk. In recent years attempts have been made to produce the cellulose filaments in short lengths so as to make it possible to manufacture yarn from the material by the methods ordinarily adopted in the spinning of wool, cotton and flax, which are carded, drawn and spun. Artificial silk in the loose form can also be mixed with other textile materials to produce various effects in construction and design. There are a number of different processes of manufacturing yarn from cellulose in the loose form, the idea having evidently originated with R. L'Huilier and L. Maurice (French patent 405,684, of Aug. 3, 1909 and addition Jan. 10, 1910).

The system devised by A. Bloch (French patent 447,069, Oct. 17, 1911) is a typical method of the manufacture of artificial cotton. The operation is as follows:

1. The cellulose is immersed in a slightly alkaline bath in order to remove the fatty material. The excess of water is removed by a hydro-extractor.

2. The cellulose is next bleached in a solution made up of 2 parts of chloride of lime to 1,000 parts of water. The material is then passed through a weak solution of carbonate of soda or potash. In order to avoid the presence of chloride of lime in the cellulose, the solution used for the first operation can be replaced with the following:

10 parts chloride of lime,
6 parts sulphate of alumina,
 $\frac{2}{3}$ parts sulphate of magnesia,
200 parts water.

The hypochlorite thus obtained is very unstable and gives up the chlorine very easily, resulting in a rapid and perfect bleaching.

3. The cellulose is washed in running water and then hydroextracted.

4. The cellulose is dissolved in a Schweitzer reagent in the usual manner. This reagent is made in the ordinary man-

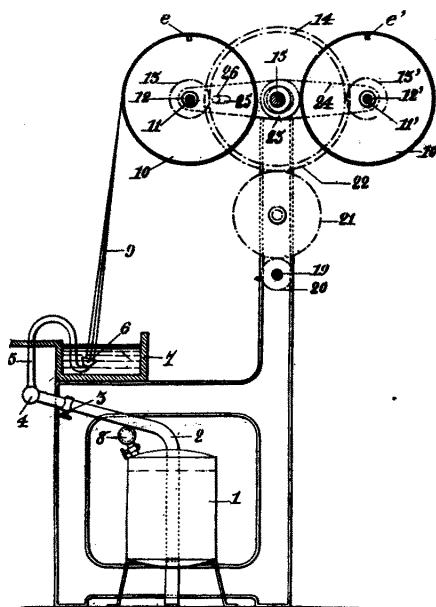

FIG. 1

ner, or better by passing the ammonia over copper in contact with air.

5. The solution of cellulose is run through a pressure filter. This is the ordinary filtering process, adding one part of castor oil to 1,000 parts of the solution.

6. The cellulose coming from the filter falls into the hydro-extractor, having a basket which is perforated with an immense number of very small holes through which the solution escapes by centrifugal force in the form of a filament. These filaments fall in a precipitating liquor consisting of water and sulphuric acid. The interior walls of this precipitating tank are covered with a

kind of card clothing with plated wire. This clothing can be removed at will. The metallic points retain the fibers and prevent them from falling to the bottom of the tank and becoming agglutinated.

The process (French patent 438,131, March 6, 1911) invented by P. Girard, differs completely from the preceding and is applicable to all kinds of artificial filaments obtained by pressure. The continuous artificial

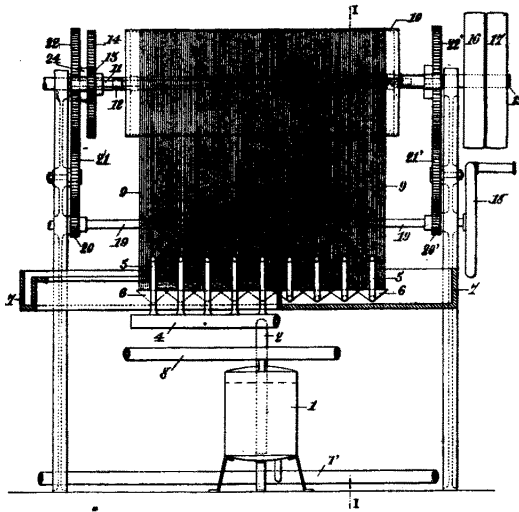

FIG. 2

filaments as they come from the machine and the coagulating baths are wound in groups on bobbins, whose diameter varies with the length of fiber desired. When a sufficient quantity of the yarn is wound it is cut from the bobbins. This produces a mass of loose fibers varying uniformly in length according to the increase in the size of the bobbins. The machine used for the Girard process is illustrated at Figs. 1, 2 and 5.

The solution of viscose which is to form the filament is stored in the tank, 1, and connected by the pipe, 2, and valve, 3, to a distributor, 4, which fits the conduits, 5, and the various filieres, 6, which are placed in the coagulating bath, 7. The pressure for forcing the viscose solution from the reservoir, 1, to the filieres, 6, is supplied by compressed air in the container, 8. The continuous filaments coming from the filieres, 6, are formed in groups, 9, the number of filaments in each group being as large as possible. On

the other hand, it is an advantage to make the filament as fine as possible. This is one of the special characteristics of this process, the filaments not being heavier than two deniers.

The filaments in groups are wound on the large spool, 10, which is operated in combination with another spool, 10', to accelerate the work, one being substituted for the other when necessary. The number of pairs of spools on one machine depends on the special requirements of each case. These spools are mounted on the shafts, 11 and 11', which are connected with a sprocket chain, 24. The power is obtained from the shaft, 15, and transmitted by the gears, 13, 13' and 14. Both the spools are driven by the same gear so that a full spool can easily be replaced with an empty spool. Power is transmitted to the shaft, 15, by the chain of gears as shown.

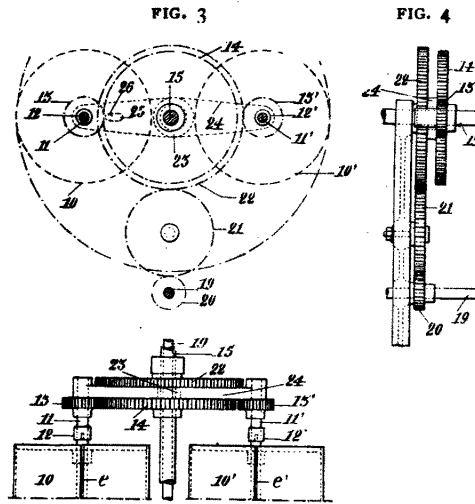

FIG. 5

The next operation is to cut the filaments from the spools. The spools, 10 and 10', Fig. 5, are made with a slit, e and e', which permits the introduction of a blade which cuts the filaments. The filieres ordinarily used are made of glass, which, as is well known, wear quite rapidly with the result that the apertures grow larger.

Fig. 2 is a front view of the machine shown in section at Fig. 1. Figs. 3 and 4 are side and end views respectively of the chain of gears.