

The Weaver's Journal

\$ 2.00

JULY 1977

VOLUME II NUMBER 1

ISSUE 5

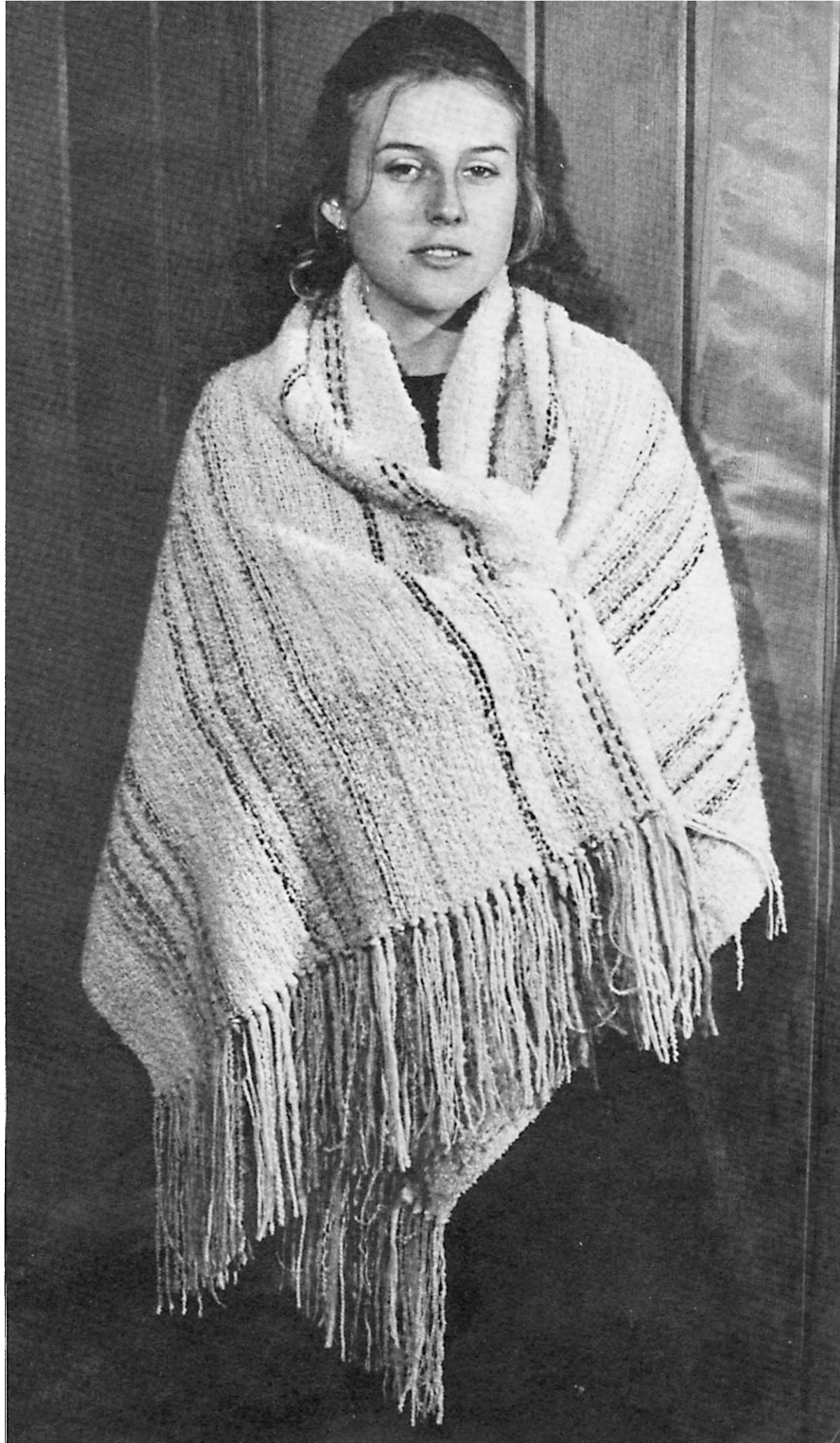

The Weaver's Journal

Quarterly Journal For Textile Craftsmen

Volume II, Number 1, Issue 5

July, 1977

Table of Contents

Letter from the Editor.....	2
Stoles and Scarves.....	3
New Products.....	7
The Vertical Loom (continued) Part II, The Two-Beam Loom.....	8
The Peacock - Designing Borders on Clothing by Barbara Knollenberg.....	12
Double Woven Tea Cosy.....	15
The Tallis or Prayer Shawl by Mary Derr.....	16
Bound Weave Rugs by Yoko Tamari Harrold.....	20
Rugs Based on Four Harness Twills.....	23
Book Reviews by Clotilde Barrett.....	29
Textile Arts of India by Ronald M. Bernier.....	31
Weaver's Market.....	38
List of Advertisers.....	38

Editor and Publisher - Clotilde Barrett
Fashion Editor - Barbara Knollenberg
Associate Editors - Mary Derr and Maxine Wendler
Copy Editor - Earl Barrett
Advertising Manager - Jeanne Richards
Circulation Manager - Iris Richards
Promotion Director - Willy Bottema
Photography - Earl Barrett

The Weaver's Journal is published on the first of each January, April, July and October at 2950 Pearl Street, Boulder, Colorado 80301. Telephone (303) 449-1170.

Subscription rates are \$8.00 for 1 year (4 issues) or \$15.00 for 2 years (8 issues). (Colorado residents add 3% sales tax).

Outside the U.S. add \$2.00 per year to the yearly subscription price.

Copyright Clotilde Barrett 1977. Second class postage applied for at Boulder, Colorado 80302.

The editorial committee takes no responsibility for the goods advertised in this journal.

Letter from the Editor

Up to now we have not published the comments from our readers. Believe it, we would be happy and proud for everyone to know what our readers write to us. Our main reason for not having a "letters" column is that our type is large and the articles that we have prepared for a particular issue always overflow the available pages. We are trying to increase the number of pages as the journal prospers. Now, for the next issue, which will be devoted to wool as a fiber for the textile artist, we would like to poll our readers and publish their opinions. The question is: What are your problems and your great moments with wool? Tell us about your pleasures and disappointments when you purchase, spin, dye and use wool.

We hope that we will receive your comments promptly because the October issue is put together long before the Fall comes upon us.

**Come and weave at Lilly Bohlin's
internationally-known weaving school.
Workshops are offered the year round.
All aspects of weaving are explored
as well as spinning and design.**

WEAVERS' LOFT

1021 Government St.
Victoria, B.C., Canada
V8W 1X6
604-388-6306

STAVROS KOUYOUMOUTZAKIS

**WORKSHOP SPUN WOOLS
EXPORTS: YARNS-WOOLS-TEXTILES
YARNS FROM NATURAL WOOL
DYED & UNDYED
FOR KNITTING & WEAVING
GOATS HAIR YARNS
FREE SAMPLES UPON REQUEST**

**STAVROS KOUYOUMOUTZAKIS
66 KALOKERINOU AVE
IRAKLION-CRETE-GREECE
PHONE 284-466**

ORDER ALL YOUR BOOKS ON WEAVING AND OTHER CRAFTS AT DISCOUNT

10% off on any Art or Craft title still in print.

New titles in stock. Many interesting techniques.

McCreary's "THE TRADITIONAL MORACCAN LOOM"

Belfer's "WEAVING - DESIGN AND EXPRESSION"

Hall's "MEXICAN TAPESTRY WEAVING"

KATHERINE RAMUS 2100 E. EASTMAN AVE. ENGLEWOOD, CO 80110
303-78903115



Plate 1

Woven by Jeanne Richards



Plate 2

Woven by Iris Richards

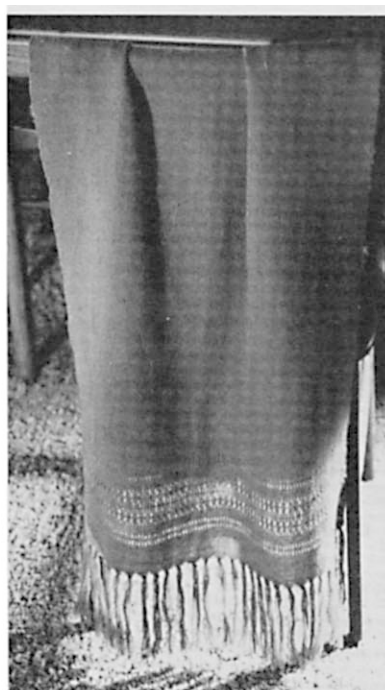

Plate 3

Woven by Maxine Wendler



Plate 4

Woven by Willy Bottema

Stoles and Scarves

Weaving stoles is rewarding to the beginning weaver. The ones illustrated in Plates 1-3 are two-harness projects in fine 2-ply wool with lace borders. For the stoles illustrated in Plates 4 and 5 the weaver may choose assorted woolens and mohairs in natural shades, mixing novelty and plain yarns in the warp. The background weaves are 4-harness twills. The border design in Plate 4 is Danish medallion which is not pulled tight.



Plate 5

Woven by Maxine Wendler



NOTICE ALL GUILDS: A free Get-acquainted examination copy of "The Weaver's Journal" will be mailed to your president upon request.

Free one-year subscription or renewal to your guild in exchange for nine subscription years from your members (new or renewal) mailed in one envelope, accompanied by full payment.



Finger Manipulated Laces For Borders of Stoles

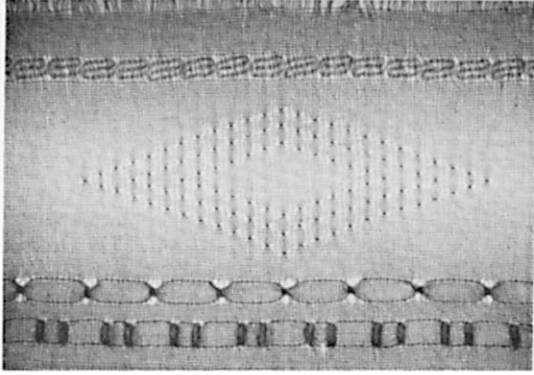

Plate 6

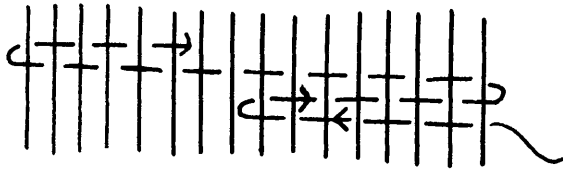

Fig. 1

Plate 7 illustrates a detail of a wallhanging which was threaded on a point twill and decorated with areas of plain weave, Spanish lace, leno and wrapping.

2. WARP BOUQUET, also known as Brooks Bouquet. Start the lace pick at the right with the first warp end up. The shed is kept open for the entire pick. Weave under 3 warp ends. *Bring the shuttle up and back over 3 warp ends and insert the shuttle again from right to left under 6 warp ends. See Fig. 2. Repeat from *.

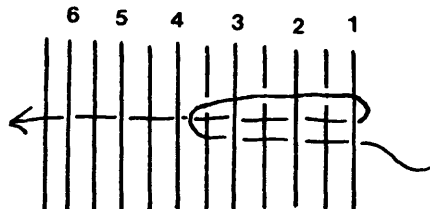

Fig. 2

The three lace techniques illustrated in Plate 6 are woven on a plain weave threading. The sample is woven with 2-ply wool worsted (Maypole "Willamette") set at 15 e.p.i. (60/10cm).

1. SPANISH LACE (top of sampler). Choose a heavier pattern weft for the lace. Start at the right-hand side of the loom and open the shed for which the first warp is up. Insert the pattern weft under 6 warp ends. *Change the shed, weave left to right under 6 warp ends. Change the shed, weave right to left under 12 warp ends. See Fig. 1. Repeat from *.

If the weft is beaten in, this technique is called Spanish weave. If the weft is pulled tight, grouping the warp in bunches, and not beaten in, the weave is lacy. This entire lace pick may be used alone or may be repeated. The lace pick may be woven from left to right if necessary. Experiment by varying the number of warp ends pulled in bunches.

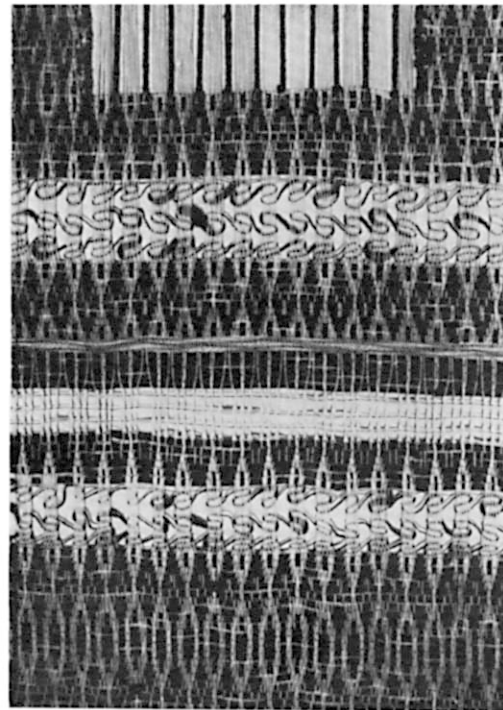

Plate 7

Keep the weft tight. Do not beat. For the return pick, change the shed, weave plain and beat. Weave two or four more picks of plain weave and repeat the lace pick as desired. Fig. 3 and Plate 6 show a diamond motif obtained by arranging the warp bouquets along diagonal lines.

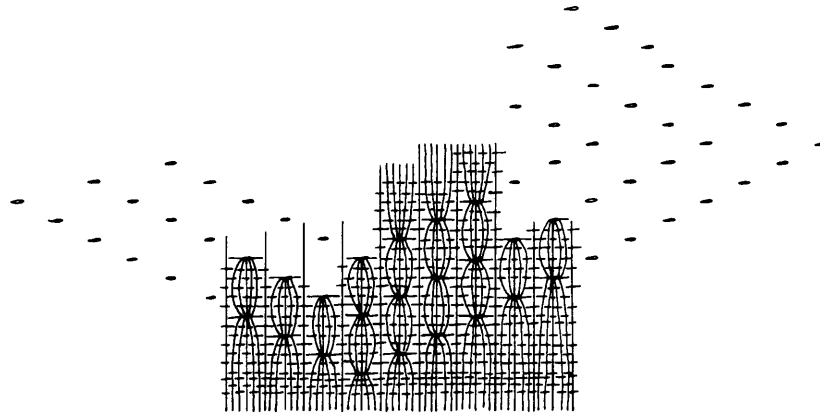

Fig. 3

3. WEFT BOUQUET - Danish Medallion. For this lace, cut a piece of pattern weft as long as 4 times the width of the cloth. Open a shed and insert the pattern weft with only 1½" hanging out on the left side of the cloth. Change the shed and weave 7 (or any odd number) of background tabby picks. Change shed and keep it open for the entire weft pick. *Insert the pattern weft from right to left under 12 warp ends.

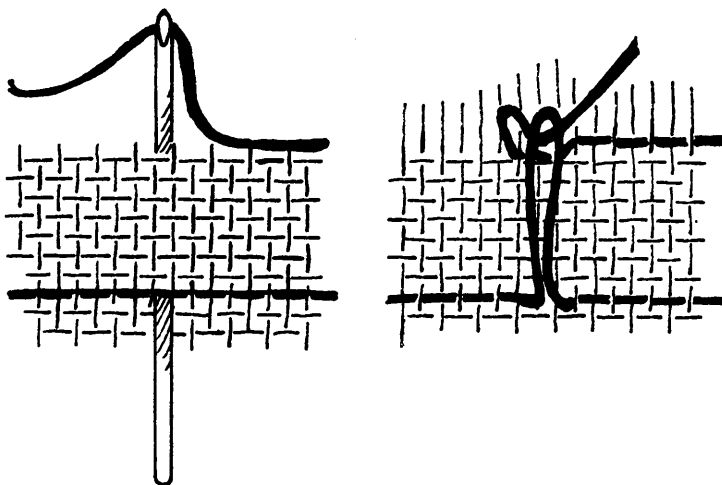

Fig. 4

Insert a crochet hook under the first pattern pick and the 7 background picks, catch the pattern weft and pull up a loop (see Fig. 4). Pass the pattern weft through the loop and pull tight. Repeat from *. Plate 6 shows a row of Danish medallion which has been pulled tight and a row which is loose.

Description of the Stoles

BLUE SCARF WITH SPANISH LACE
Plates 1 and 8.

Warp: Maypole 2-ply wool worsted.
Weft: Background, same as warp. Pattern, 3-ply Maypole, two fold.
Sett: 15 e.p.i. (60/10cm).
Threading: Plain weave.
Width in the Reed: 12" (30cm).
Length on the Loom: 54" (137cm) without fringe.
Finished size after washing: 10 3/4" x 48 3/4" (27 x 124cm) plus fringe.

<p>WEAVING WORKSHOPS:</p> <p>Clotilde Barrett, ed. and publisher of "<i>The Weaver's Journal</i>", will travel to give workshops and lectures. Address inquiries to:</p> <p>Clotilde Barrett 624 Peakview Boulder, CO 80302</p>

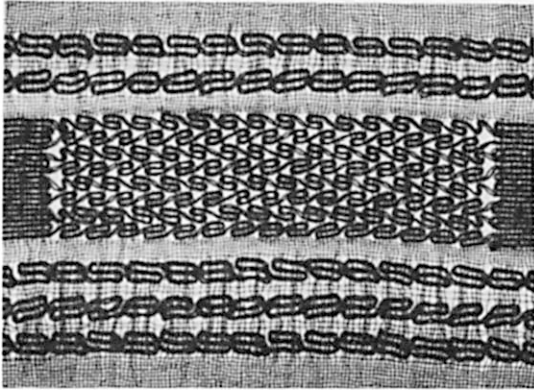

Plate 8

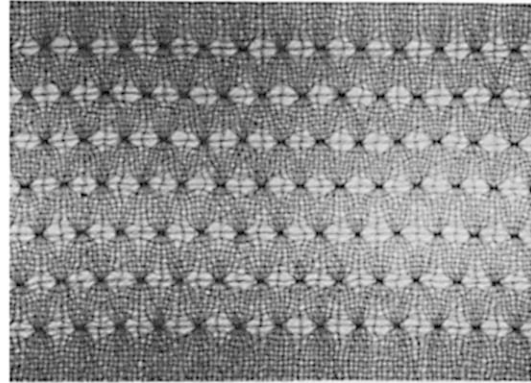

Plate 9

NATURAL WHITE STOLE WITH WARP BOUQUETS. Plates 2 and 9

Warp: Maypole 2-ply worsted.
 Weft: Same as warp.
 Sett: 15 e.p.i. (60/10cm).
 Threading: Plain weave.
 Width in the Reed: 22" (55cm).
 Length on the Loom: 72" (183cm) without fringe.
 Finished Size After Washing: 18 3/4" x 63 1/2" (47.5 x 162cm) plus fringe.

BLUE STOLE WITH PICK-UP LENO. Plates 3 and 10



Plate 10

Warp: Fine 2-ply wool used twofold.
 Weft: Same as warp.
 Sett: 10 e.p.i. (40/10cm).
 Threading: Plain weave.
 Width in the Reed: 26" (65cm).
 Length on the Loom; 72" (183cm) without fringe.
 Finished Size After Washing: 23" x 64" (58.5 x 175cm) plus fringe.

The border design is made up of Antique Mexican Singles and Antique Mexican Doubles as described in Vol.I, No. 2, Issue 2 of *"The Weaver's Journal"*.

WHITE TEXTURED STOLE WITH BLACK DANISH MEDALLIONS. Plates 4 and 11

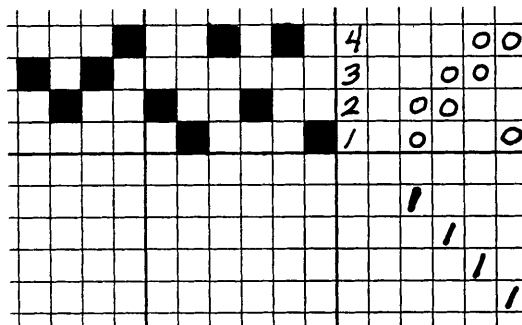

Fig. 5

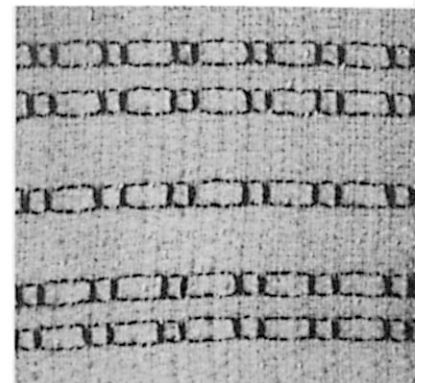

Plate 11

Warp: Assorted wool and wool-rayon blends in heavily textured and smooth yarns.
 Weft: A soft smooth wool and a finely textured wool (Ratine) wound together on the shuttle.

Sett: 8 e.p.i. (30/10cm).

Threading and Treadling: Skip twill for which the draft is given in Fig. 5.

Width in the Reed: 30" (80cm).

Length on the Loom: 72" (183cm) without fringe.

Finished Size After Washing: 24" x 67" (60 x 170cm) plus fringe.

The pattern weft for the Danish medallion should always be woven in the same twill shed.

TEXTURED STOLE IN NATURAL COLORS. Plates 5 and 12

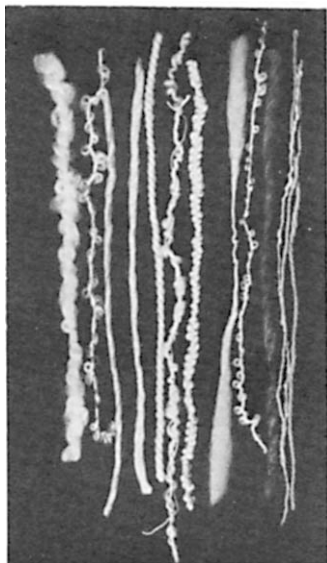

Plate 12

Warp: Assorted natural white novelty wool, 3 shades of grey Lopi (Iceland wool), 1 dark brown loop, 1 variegated brown loop, 1 reddish brown, 1 beige plain wool.
 Weft: Medium weight loop wool from H. Bathgate, Galashiels, Scotland.

Sett: 8 e.p.i. (30/10cm).

Threading and Treadling: Broken twill for which the draft is given in Fig. 6.

Width in the Reed: 33" (88cm).

Length on the Loom: 72" (183cm) without fringe.

Finished Size After Washing: 30½" x 67" (77.5 x 170cm) plus fringe.

All the stoles have been machine washed on wool setting with Ivory liquid, then laid on a flat surface to dry. The non-textured stoles needed steam pressing. The textured stoles should be pinned to a mattress pad while drying. Before the stole is completely dry, the stole may be brushed with a wire brush to raise a nap.

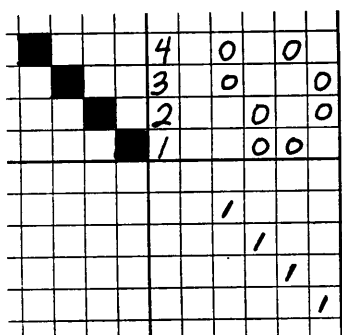
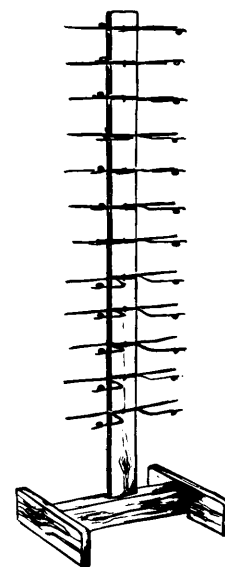

Fig. 6



New Products

Harold Ryan, of Denver, designed this spoolrack made from maple. The model illustrated holds 24 four inch (10cm) standard spools with slip threading through its eyes. Overall size is 46" (117cm) high with a 15" x 14" (38 x 36cm) base. For 48 spool capacity, two racks can be paired on a special stand.



The Vertical Loom (continued)

Part II, The Two-Beam Loom

In the development of the vertical loom we have seen that the one-bar loom (or half loom) is suited for free hanging warp. The tensioning system that we have studied so far relies on gravity: the warp is weighted at one end.

Two-beam looms are occasionally used without tensioning devices but the advantage of the two-beam loom lies in the various possibilities of tensioning the warp.

Twining Frame

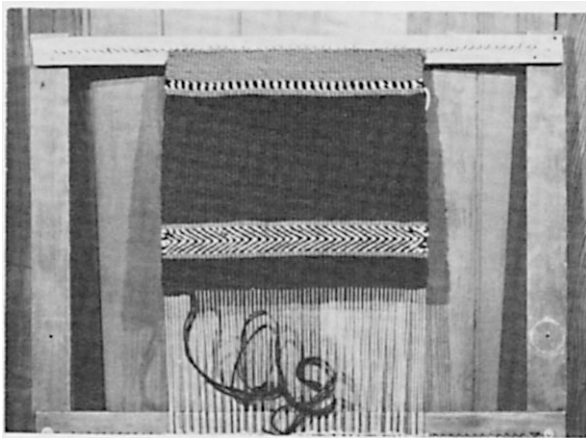

Plate 1

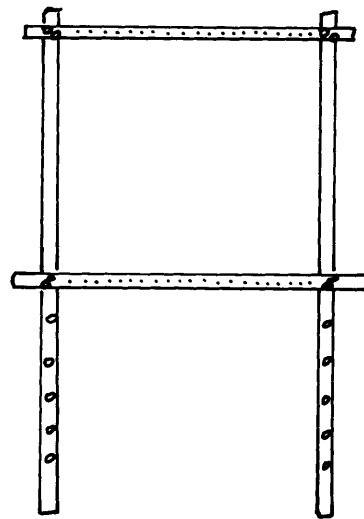

Fig. 1

The twining frame shown in Fig. 1 and Plate 1 is a simple and practical loom for projects for which a tensioning system is not necessary. It is practical for twining, and was seen being used by an elderly lady in Boulder, Colorado to twine rag rugs. It is built with 1 x 3" lumber. The uprights are 4.5' (137cm) long, the crossbeams 3' (92cm) long.

Each crossbeam has a row of 1" (2.5cm) finishing nails $\frac{1}{2}$ " (12.7mm) apart, (drill a pilot hole before hammering in the nail, to keep the wood from splitting). The top beam is bolted on to the upright with two bolts and wingnuts in each corner. An additional corner brace is desirable. The lower beam is bolted to the lower part of the uprights. Put several holes in the upright to allow for different positions of the lower beam. This will determine the size of the rug or tapestry. A sturdy wool or cotton rug warp is attached to a nail and then wound back and forth around the nails of the upper and lower beam. There will be 4 warp ends per inch (16/10cm). Twine a few rows over single warp ends close to each row of nails and then twine or weave the rest of the project. The finished product has 4 selvages.

The Salish Loom

The territory of the Salish Indians lies on the West coast of America in

Canada and the United States, and encompasses most of the state of Washington and the southern half of British Columbia.

In ancient times (before 1850) a great variety of textile articles were made by the Coast Salish tribes. These include the common blankets, the ceremonial blankets, tumplines, belts, sashes, skirts, dancing aprons, capes, nets, snowshoes and headdresses. These Indians were also adept at making baskets, hats, and various types of mats for bed and floor use. However, the uniqueness of Salish textiles manifests itself foremost through their blankets.

The common Salish blankets were up to 5' (152cm) wide. The shorter ones (5' to 6', 152 to 183cm long) were used as cloaks; the longer ones (10' to 12', 304 to 366cm) were the bedcovers of the aristocracy. The yarns were coarsely spun doghair or wool from mountain goats. The blankets were usually white, ornamented with black, brown, or red stripes running crosswise, lengthwise or both. The weave is mostly twill. On rare occasions these blankets were decorated with a colored twined border on each end.

The ceremonial blankets, also called nobility blankets, were the cloaks used by the aristocracy for ceremonial occasions. They are about 30" x 36" (76 x 92cm) in size. The yarn is finely spun doghair, goat wool and the brightly colored (aniline dyed) wool introduced by the white traders. These blankets are either twined or woven in a twill weave combined with twining techniques. Both ends of the blankets were always ornamented with colored designs. Often there was an all-over pattern made up from well planned designs. These designs are related to those found in basketry from the same regions, and are often worked out in the same three-color combinations: black, red and white.

The Salish tribes weave their blankets on a two-bar loom. The loom was set up in the house or out-of-doors. During the Great Pueblo period the Anasazi wove cotton fabrics on such vertical looms. It is believed by some scholars that Salish tribes migrated from the Southwest and brought their looms and the art of weaving with them, joining the other Northwest coast tribes between 1300 and 1600.

The Salish two-bar loom (Fig. 2) consists of two vertical posts in which slots are cut at various distances to receive the ends of the two cross-beams or rollers.

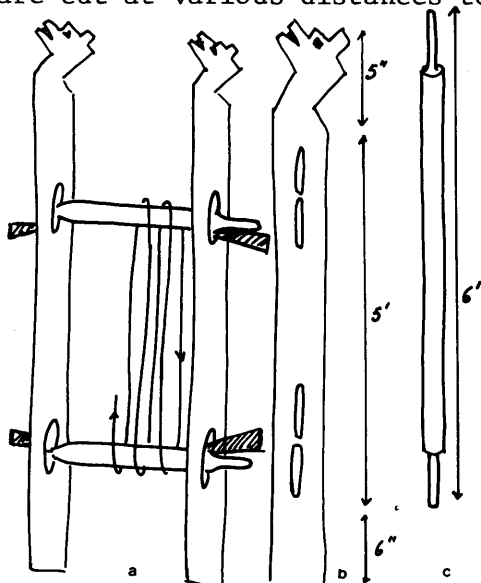

Fig. 2

The warp is wound around these rollers. They are held in place by wedges which tighten the warp as they are driven into the slots and thus stretch the rollers apart. This loom can be used to weave a blanket with a continuous (circular) warp (Fig. 2a) which must be cut to remove the blanket. The cut is made in the middle of a band of warp which is left unwoven. The cut warp ends make fringes on both sides of the rug. The loom can also be used to weave blankets whose warp is looped at each end around a rod or heavy string tied horizontally across the loom (Fig. 3).

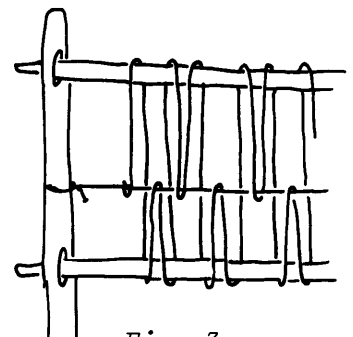

Fig. 3

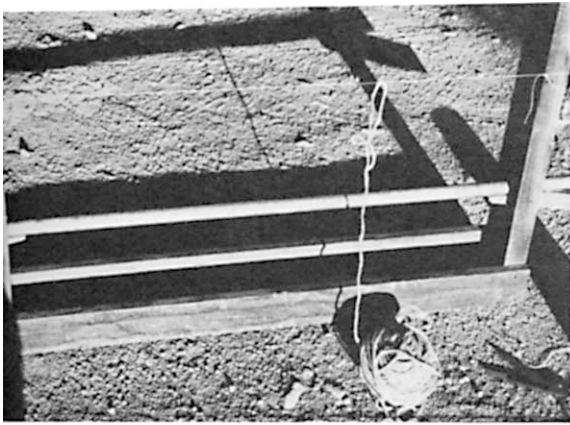
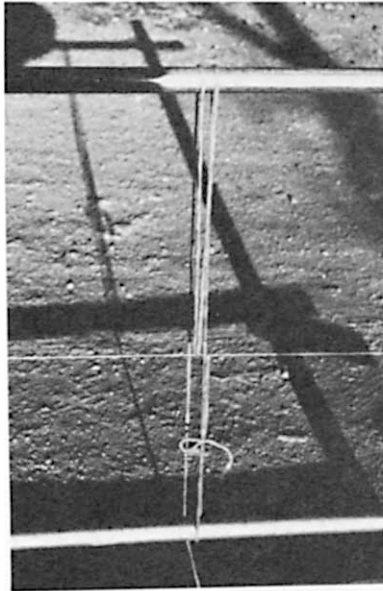

Plate 2 Plate 3



Plates 2,3,4 and 5 show several steps of this set-up on a small Salish loom built with 2 x 4" lumber and conduit.

Although this loom is only 32"H x 36"W (81 x 92cm) in overall size, it is practical for tapestries up to 44" (117cm) long.

Plate 5 shows how the twining is started about 1" (2.5cm) below the rod or the string. This will result in a 1" uncut or looped fringe.

The other end of the rug has been started to stabilize the warp as it is moved around the beams in the course of the twining. The wedges have to be removed and the warp tension released when the warp is to be turned.

Common and ceremonial blankets are woven on this loom. The textile techniques which are predominant in Salish blankets are twining, plain weave and twill. The weaving progresses from top to bottom and no special mechanism is used for making a shed. The sheds for twill weaves are made by picking up the warp ends with the fingers. The weft is inserted with the fingers or with a shuttle. In some cases a wooden sword is used to keep the shed open and to serve as a batten to drive in the weft.

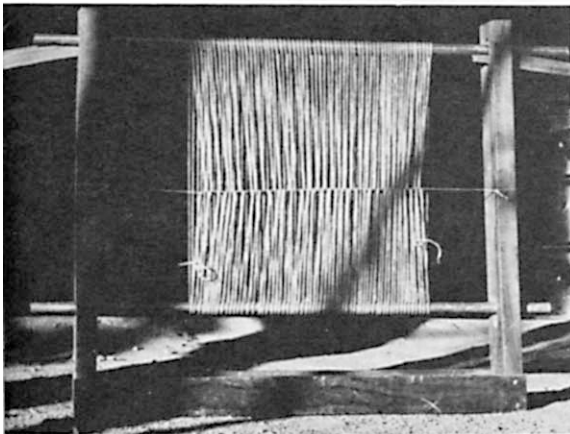

Plate 4 Plate 5

Making The Basic Frame Into a 2-Bar Loom

Materials Needed:

See materials for the basic frame, Vertical loom, Part I, "The Weaver's Journal", Vol. I No. 3.

Two wooden wedges (Fig. 4)

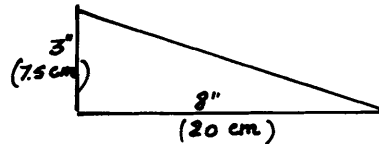
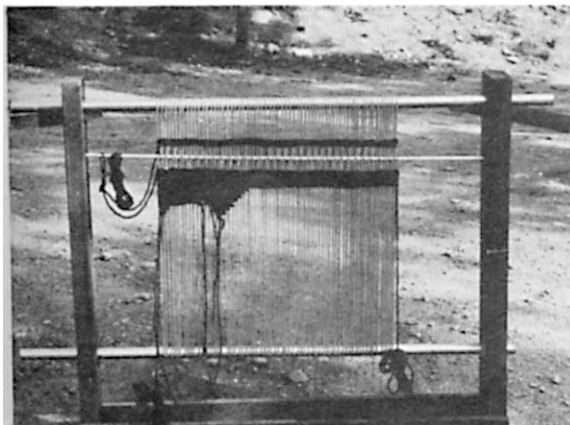

Fig. 4



Build the frame as shown in Vol. 1 No. 3, p. 21, but bolt the upper brace of the frame on the back-side of the loom, outside the frame. Omit the top crotches for the beam.

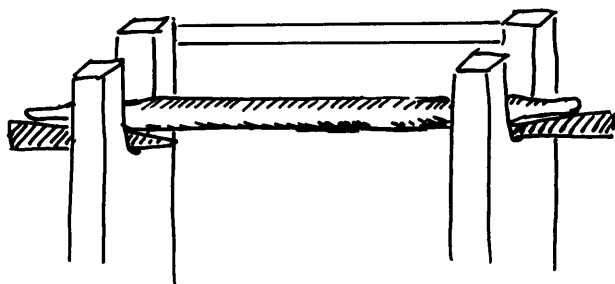

Fig. 5

Cut a slot in the uprights as shown in Fig. 5. The lower beam will go through the holes in the feet of the frame, the upper beam will lie in the slots, and the warp is put under tension with the two wedges.

Other Tensioning Systems Used On Two-Bar Looms

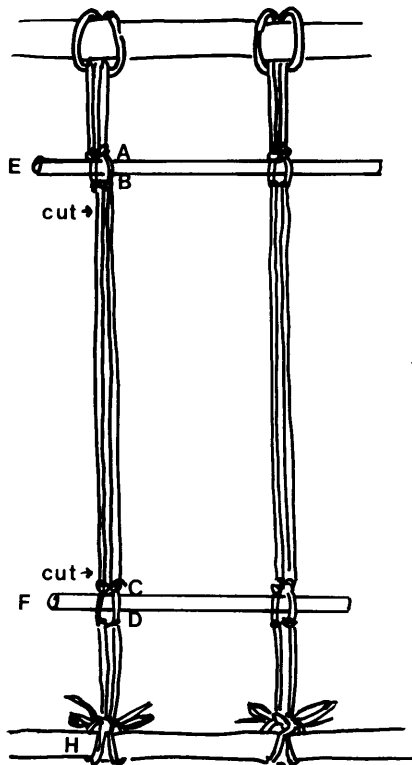

Fig. 6

A. Two strong cords are attached with a larkshead to the top brace of a frame. In each double strand tie two overhand knots, 1" (2.5cm) apart A & B, then again two overhand knots 1" apart, C & D. At the lower brace, wrap each end around the brace and tie the ends together with a knot and bow. Slide the bars E and F through the loops between A and B and C and D. Wind a continuous warp around these two bars. Cut out the piece of cord between B and C and tighten the knots at H to adjust the tension.

* * *

B. Wind the warp similarly to the warp in Fig. 3 but use two rods instead of one. The rods are about 6" (15cm) apart. See Fig. 7. When the warp is made, a lacing cord is tightened to tighten the warp. (Fig. 7).

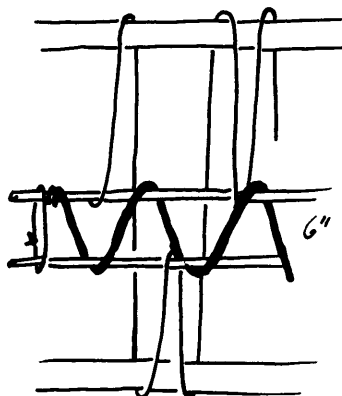

Fig. 7

* * *

C. The warp is supported by the two bars A and B. (Fig. 8). Bar A is laced to the upper brace of the frame. The lacing cord is tightened to make the warp tighter.

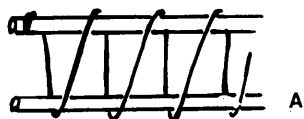

Fig. 8

The tensioning mechanics used by the Navajo Indians is of this type and will be discussed in detail in the next article on vertical looms.

In the last two methods, turnbuckles may be used instead of lacing cords.

* * *

D. In the Moroccan loom, the warp is tensioned by winding it around a beam. The beam is then anchored to the upright in a position so that the warp is tight. See "Moroccan Loom" by Carol Fillips McCreary in this issue's book review.

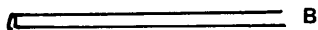



Designing Borders on Clothing

by Barbara Knollenberg

Designing handwoven clothing takes special thought and careful planning to arrive at wearable and attractive garments. Borders on handwoven clothing take even more careful planning and thought. Outlined and explained below are four designing and execution stages specifically for borders on handwoven clothing.

1) Select the garment and the border motif for the garment. Most border motifs produce a straight pattern across the width of your woven fabric like a stripe; the chosen garment should therefore have straight lines in the border area. This is especially true of the hem area. Simple garment construction best displays borders which are the focal point of the garment. Skirts should be of two or three panels only, and dresses of clean straight lines with few construction details. Below are inspirations for border placement on various garments:

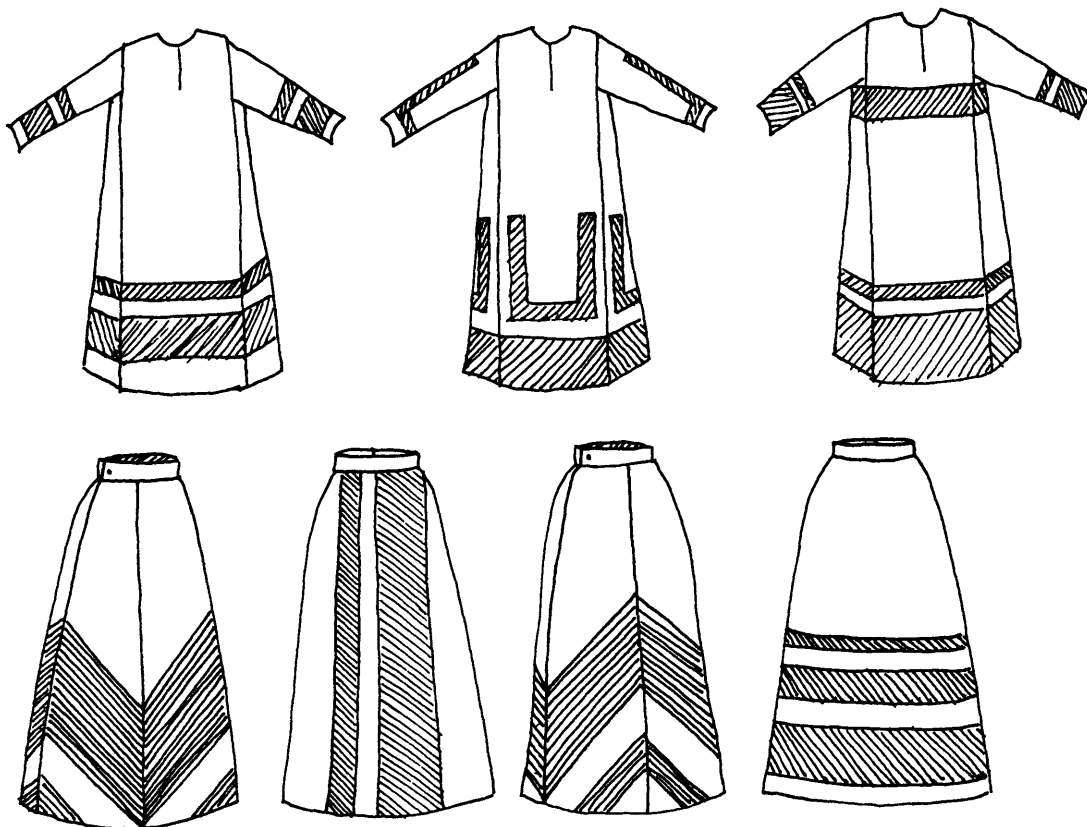

Fig. 1

Consider the proportion of your border width to the whole garment length if the garment is shorter, such as a jacket. The border proportion of $\frac{1}{3}$, $\frac{1}{5}$, and $\frac{3}{5}$ seem to be the most aesthetic. (Fig. 2). Placing the border 3 to 5 inches above the hem line helps to balance the proportions of a garment as well as aiding in hemming the garment.

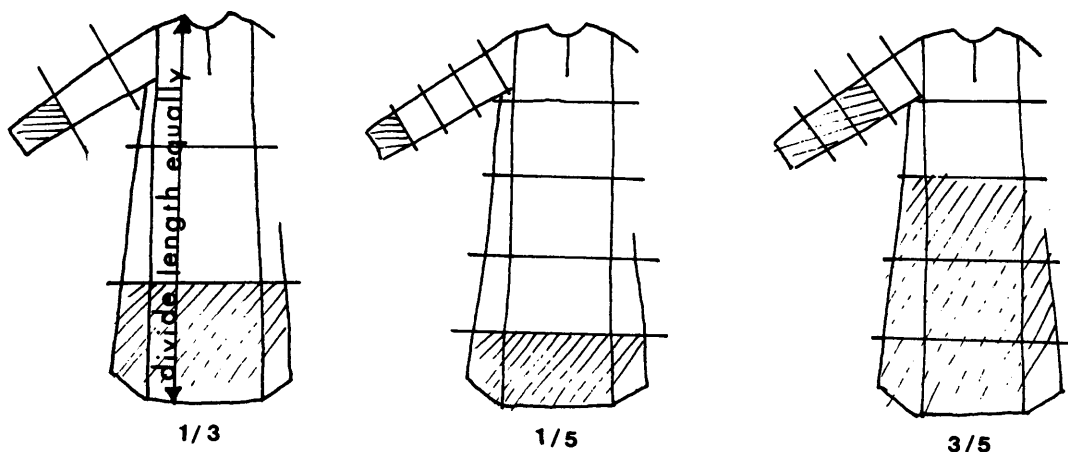

Fig. 2

All types of weaves or weaving motifs can be suitable for creating garment borders. The weaves I suggest as having more interesting border potential are:

- overshot
- doubleweave - patterned or pick-up
- crackle
- summer and winter
- plain weave with heavier wefts
- monk's belt
- lace weaves

2) Choose yarns and make samples of your chosen motif. For comfortable wear and easier construction into garments choose fine sized yarns for the body of the garment and multi-ply or heavy yarns in the borders only. Yarns yielding a 50/50 web at 15-60 e.p.i. (60-240/10cm) are the most suitable yarns for garments. I have found yarns of 20-30 e.p.i. (80-120/10cm) weight as the most useable for garments worn next to the body such as dresses, and coarse and heavy yarns as suitable for sculptural effects of borders where weight is desired.

Making samples is useful in enabling you to visualize your border motif size and to test your yarn's response to cleaning, as well as providing an accurate guide for calculating take-up amounts of the warp and weft. The correct warp e.p.i. and weft p.p.i. is also tested with sample making. As an example, an overshot motif woven as predominately warp face fabric will extend the motif out of its usual squareness that occurs as a 50/50 web fabric. (Plate 1 and 2).

3) Plan and calculate your warp needs. The choice of garment determines the length and width of your warp. The number and length of the main large pieces of a garment determines the length of the warp. Measure each piece. The widest main piece determines the width of the warp needed. Allowances for take-up and shrinkage of warp length and width must be added to the garment's total length needs in order to calculate the total warp length. Formula to use:

Finished length of fabric + 10% take-up + % shrinkage after cleaning + 1 yard loom waste = total warp length.

Finished width of fabric + 10% draw-in + % shrinkage after cleaning = width of warp.

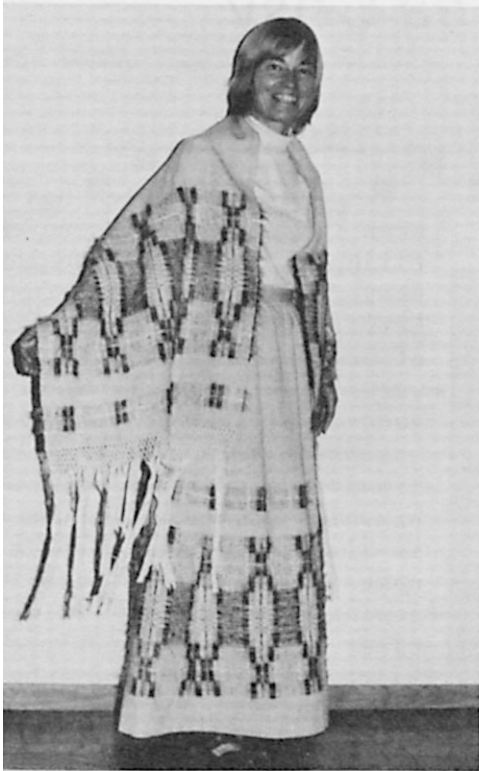

Plate 1



Plate 2

For maximum use of the fabric width it is wise to plan your warp width with symmetrically-placed border motif repetitions. Either whole or exact fractions of repetitions should occur at each selvage.

4) Plan and weave accurate fabric widths and lengths of borders. Keep a tape measure pinned to the woven web, measuring the woven panels every time you advance the warp. Measure the woven web only when the warp tension is slack. There are two ways of weaving border yardage. (Fig. 3). Your garment construction and border motif repetitions determine how the panels are woven.

Carefully match the motif repetitions of the borders when constructing the garments and you shall have created elegant garments not obtainable commercially. Happy border designing!

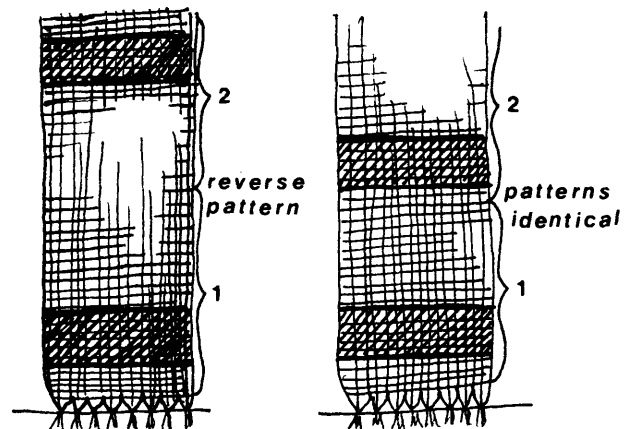

Fig. 3

The Weaver's Journal

2950 Pearl Street
Boulder, CO 80303
(303) - 449-1170

Back issues: Vol. I: Issues
1, 2, 3, 4- available at \$2
each (CO residents add 3% tax).

Double Woven Tea Cosy



*Tea Cosy
Woven by Willy Bottema*

This tea cosy which has been tubular woven is an exciting project for a beginning weaver. It requires a four-harness loom and an assortment of medium thin plain wool yarns. This project is more successful in colors such as shades of yellow which harmonize from a greenish yellow to brownish orange. The tea cosy is almost finished when it comes off the loom; very little sewing is required. Polyester fiber batting is sandwiched between the outer and inner layers of the tea cosy to improve its insulating quality.

WARP: Random stripes, bands and single ends of wool in related colors, about size 2/8.
WEFT: one single color, somewhat thinner wool than the

average warp yarn.

SETT: 20 e.p.i. (80/10cm) (the sett is high because the cloth is double woven).

WIDTH IN THE REED: 18" (44.5cm).

THREADING, TREADLING AND TIE-UP: (See Fig. 1).

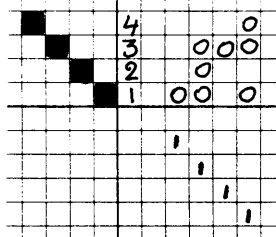

Fig. 1

For a tubular weave the total number of warp ends should be odd. Discard the first warp end which is on harness 1. The warp on harnesses 1 and 3 makes the top layer. The warp on harnesses 2 and 4 makes the bottom layer. The tube should be 31" (79cm) long on the loom.

Wash and steam the cloth as it comes off the loom. Fold the tube as shown in Fig. 2.

Stitch along the foldline 1" (2.5cm) away from the edge. This makes a casing into which a cord is inserted to draw the top of the tea cosy together. Put a layer of batting between the inner and outer tube.

Make a handle by wrapping a ring or a piece of heavy rope with yarn. Secure it at the top

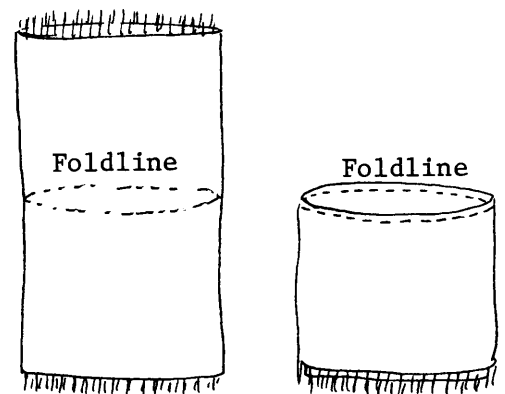
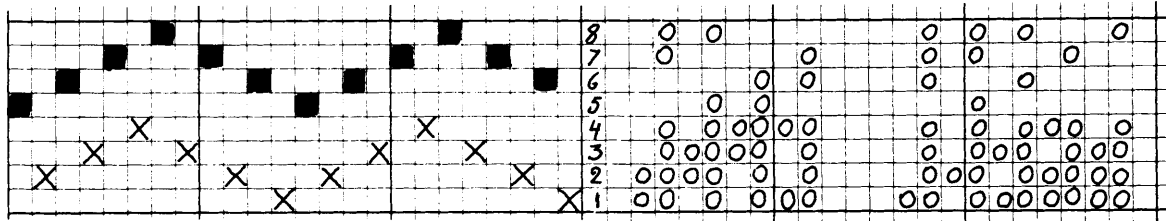

Fig. 2

of the cosy.

The weaver with an 8 harness loom may be challenged by the draft given in Fig. 3.



The warp of the top layer is represented by X's and the warp of the bottom layer is represented by ■'s. The first half of the tube which will become the outer tube could be woven in bird's eye pattern by using the tie-up and treadling A. The second half of the tube which will become the inner tube could be woven with the tie-up and treadling B, which is a waffle weave, a thermal weave affording good insulation.

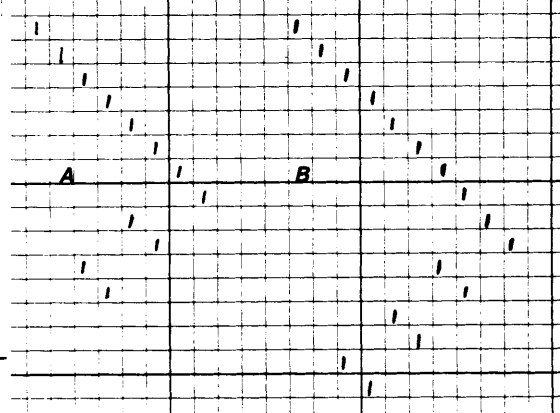

Fig. 3

Looking for New Weaving Techniques?

In addition to a remarkable line of weaving supplies, Greentree carries books. A good weaving library is something any serious weaver can use and enjoy. Those books listed below are especially good; we have many others as well. Write and ask for a complete list, and remember that for any order of two or more books, we pay postage. It's even easier to order using your Mastercharge or VISA.

For Simple Equipment

Weaving on Simple Looms
Green & Redding, \$1.75 paper

For 4 Harness Looms

(also containing other information)

New Key to Weaving
Black, \$13.95 cloth

The Art of Weaving
Regensteiner, \$7.95 paper

Weaving—A Handbook for Fiber Craftsmen
Held, \$11.95 paper

For Multi-Harness Weaving

A Handbook of Weaves
Oelsner, \$5.00 paper

The Shuttlecraft Book of American Handweaving
Atwater, \$8.95 cloth

More Than Four
Laughlin, \$10.95 paper

For All Fiberarts

Designing with Thread—from Fibre to Fabric
Waller, \$14.95 cloth

Greentree Ranch Wools

163 N. CARTER LAKE ROAD
LOVELAND, COLORADO 80537

For fastest service, call us and
use your Mastercharge or VISA
303-667-6183



The Tallis or Prayer Shawl

by Mary Derr

Plate 1 Tallis Woven by Mary Gelman

Have you ever thought of weaving a prayer shawl? It is probably the oldest woven garment in the world. The prayer shawl or tallis comes from a time when shawls were worn as an ordinary outer coat. But the garment became a ceremonial one for Jews when special tassels called tzitzis were added to each corner. In the strict Orthodox synagogues, the tallis is worn only by married men. However, in Conservative or Reform congregations, the tallis is given to young boys at their Bar Mitzvah when they attain manhood. Today women often wear the tallis too. It is worn as a prayer robe, enwrapping the wearer and sheltering him from the world so he can concentrate on his prayers.

The directions for making a tallis are fairly flexible. It must be a four-cornered garment with tzitzis on each corner. Since it is forbidden to mix some fibers such as linen and wool, it is safest to use only woolen yarns. The garment must be light enough to drape comfortably over the wearer's shoulders. The use of the tzitzis is very important; it is described in the Bible (Numbers 15:37-41), where God tells Moses to instruct the Israelites to put tassels on the corners of their garments to remind them to keep themselves holy and consecrated to God.

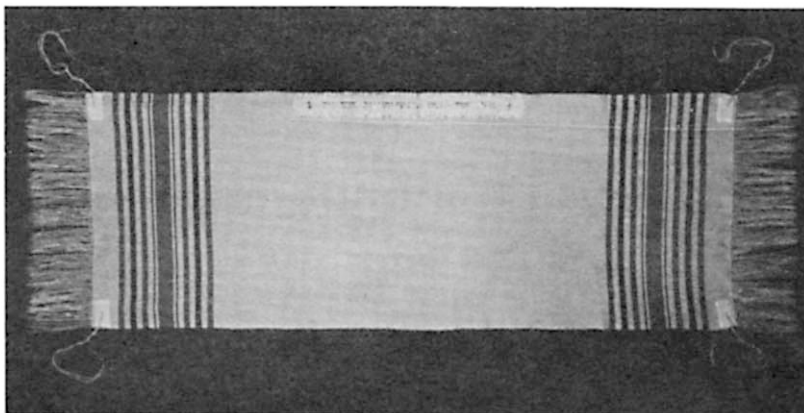

Plate 2

To weave the tallis illustrated in Plates 1 and 2 you will need a 2- or 4-harness loom, 12 ozs. 2-ply natural white worsted yarn, and 1 ounce each of medium and light blue 2-ply yarn.

Warp: 2-ply wool worsted in natural white.
 Weft: 2-ply wool natural white, medium and medium light blue.
 Sett: 24 e.p.i. (100/10cm).
 Width in the Reed: 25" (60cm).

Total Warp Ends: 600
 Length on the Loom, Without Fringe: 63" (160cm).
 Size after Finishing: 22" x 60" (50 x 152cm) with 6" (15cm) fringe.

The threading, tie-up, and treadingling are given in Fig. 1.

Before you weave the tallis itself, weave a 3" (7.5cm) band. You will use this later to reinforce the corners where the tzitzis are attached. Then leave 8" (22cm) for fringes and start to weave the tallis. The striping on the tallis is strictly decorative and may be varied as the weaver wishes. The banding for the tallis illustrated here is given in Fig. 2.

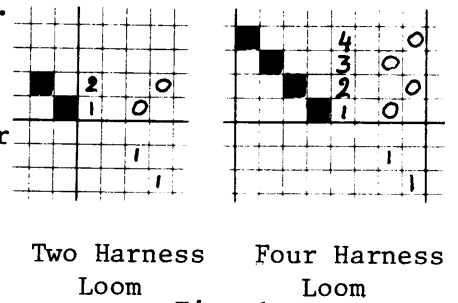

Fig. 1

When the tallis is finished, tie the fringes in groups of six with overhand knots. If you want a fancy fringe, you can tie it in two or three rows. See Fig. 3.

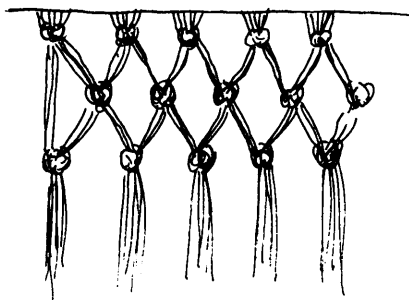

Fig. 3

Cut the 3-inch woven strip in quarters. On the wrong side of the tallis, sew one of these into each corner as a reinforcement for the tzitzis. Make a hole not less than 1 3/4" (4.5cm) or more than 2 1/4" (5.7cm) from the edge of the tallis, finished as a buttonhole or sewed so it will not fray out. See Fig. 4.

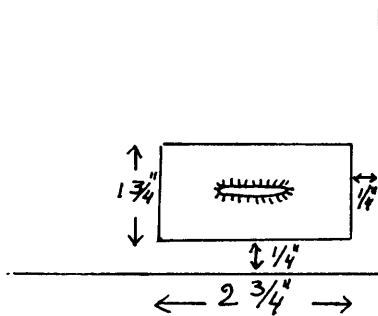

Fig. 4

You should now wash the tallis in HOT water and a detergent such as Tide or Dash. Don't add bleach or

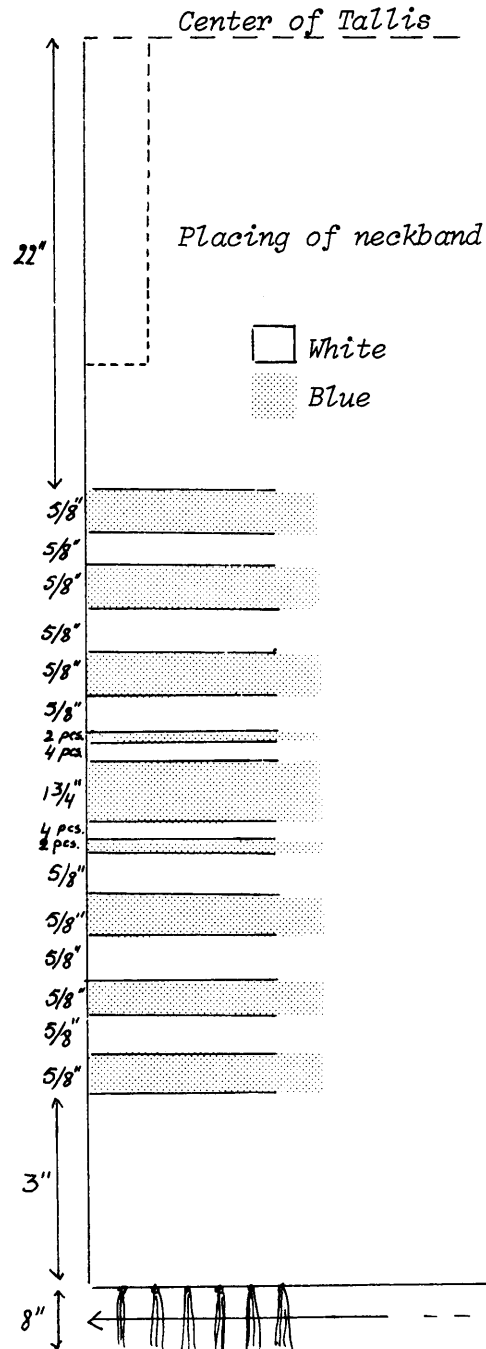

Fig. 2

bluing. Later washings should be with cool water and Woolite or Ivory. Do not wring out, but squeeze gently and drip dry over a towel bar. When it is dry, you may press it with a steam iron. You may send it to a commercial cleaner for steam pressing. The neck band is optional. It is sewn along one edge of the selvedge. See Fig. 2. This collar can be a knitted or crocheted strip, a beautiful brocade, or a commercial finished collar.

Now you are ready for the tzitzis. It is customary to hang them on the side of the corner rather than on the bottom toward the ground. You can buy finished tzitzis, but you may prefer to tie them yourself. The tzitzis are always made of woolen strands.

If you want to make your own tzitzis, it's easier if you use a tzitzis kit, available at any reliable Hebrew bookstore. It contains 16 woolen strands, four long and 12 short ones. Separate these into four groups with one long and three short strands in each. The long strand is called a shammash and is used to wind the tzitzis.

Before you make the tzitzis, loop one long and three short pieces of yarn or string around a table leg and practice tying one.

Take the four strands of one group and arrange one end of the strands until they are even, then push them through the corner hole of the tallis. Make sure the ends of seven strands are even, letting the long strand hang on one side. Now, take four strands in one hand, four in the other (including the long one), and tie a double knot (granny knot) near the edge of the material. See Fig. 5 and Plate 3.

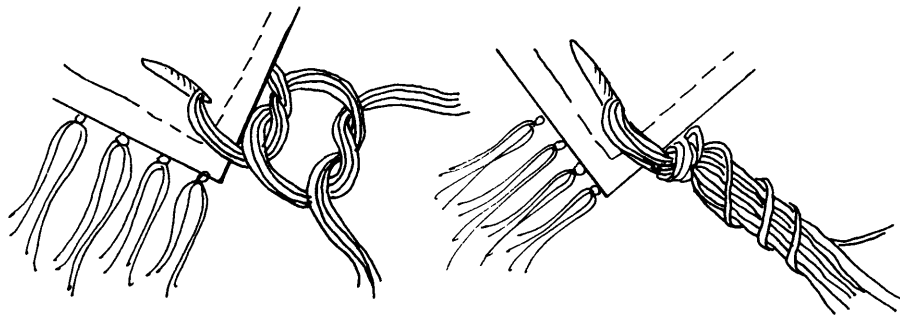

Fig. 5

Take the long strand and wind it in a spiral of 7 turns around the remaining 7 strands of wool. (Be sure to end the winding where you began, or you won't have 7 turns.) Make another double knot (four strands over four as you did before).

Now, spiral the shammash 8 times around. Double knot. Spiral the shammash 11 times around. Double knot. Spiral 13 times around. Final double knot.

The numbers used in the tzitzis are symbolic. They remind the wearer each time he sees them of the commandments of the Torah and that God is One, the very basis of his faith.



Plate 3

Bound Weave Rugs

by Yoko Tamari Harrold

The boundweave featured in the April, 1977 issue of "The Weaver's Journal" was used in the following five rugs, using two different four-harness threading arrangements.

Because of the spacing of the warp and the threading, the weft yarns pack down closely over one another, resulting in thick and firm rugs.

Many patterns can be designed on the same threading by changing the weft colors. Each color appears only in certain areas of the pattern. Fig. 1b shows the area where four colors, A, B, C, and D, appear when they are woven in sheds 1, 2, 3 and 4 respectively. The treadling sequence remains the same throughout the rug. Possibilities in designing a pattern are endless and fascinating.

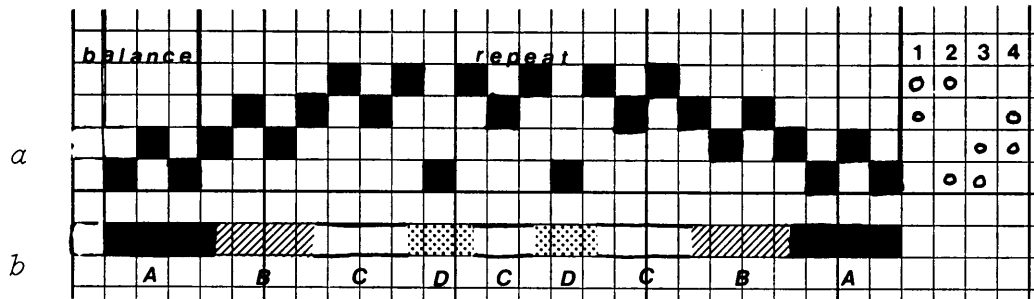

Fig. 1

Figs. 2 and 3 are examples of patterns which can be obtained from the draft in Fig. 1. Each horizontal row of four sheds (1,2,3,4) is one unit which is repeated. Patterns are formed by controlling the color for each shed. Vertical columns appear whenever the same color is used in the same shed.

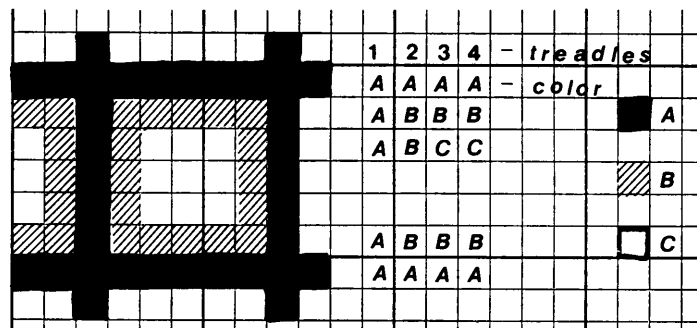

Fig. 2

The rugs shown in Plates 1-3 were woven on the draft shown in Fig. 1. There are 22 warp ends in each repeat.

WARP: 4-ply white wool rug yarn.
WEFT: Single ply wool and goat hair blend from Gustaf Werner of Sweden.

SETT: 5 e.p.i. (20/10cm).

THREADING: 7 repeats plus 3 warp ends to balance the pattern.

WIDTH IN THE REED: 31" (82.5cm).

2 warp ends are added on each side to make floating selvages.

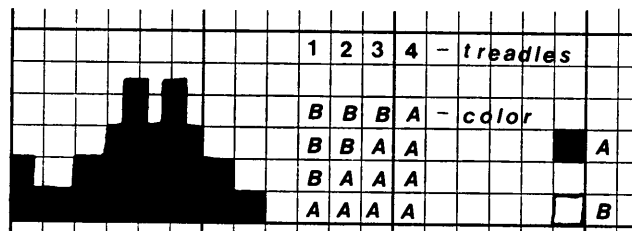

Fig. 3

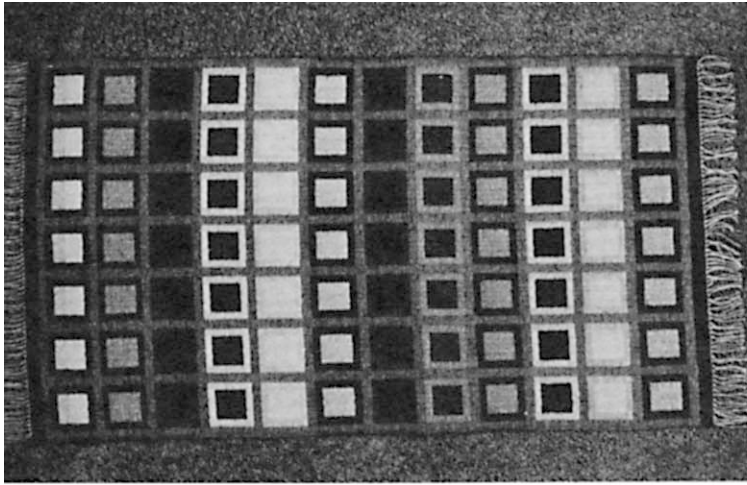

Plate 1

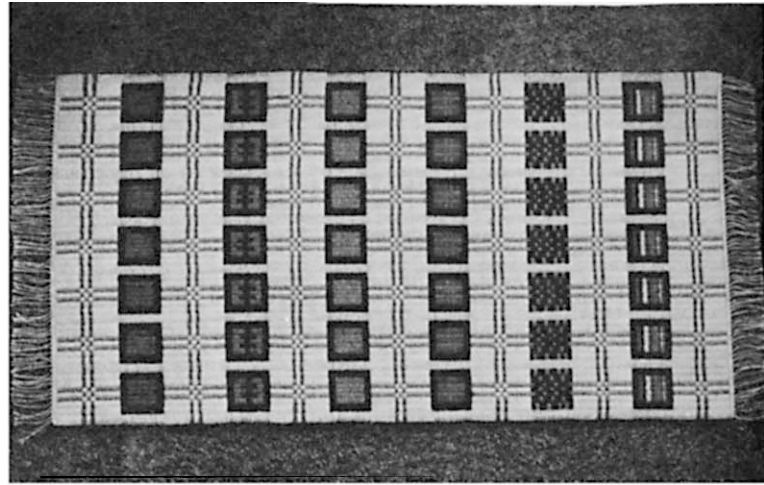

Plate 2

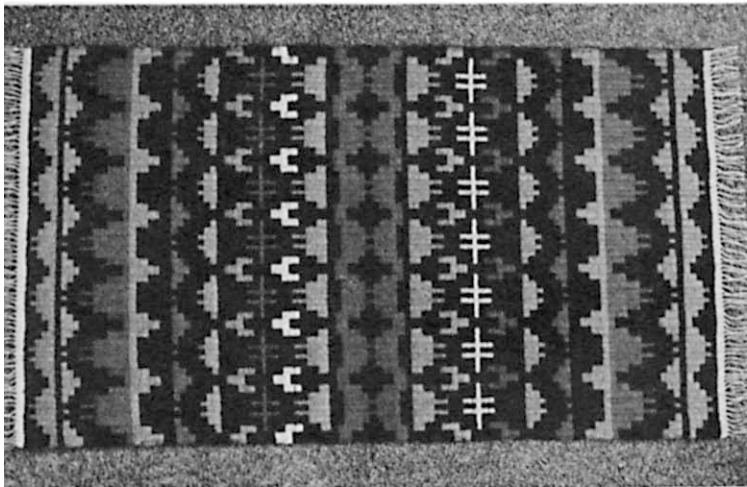

Plate 3

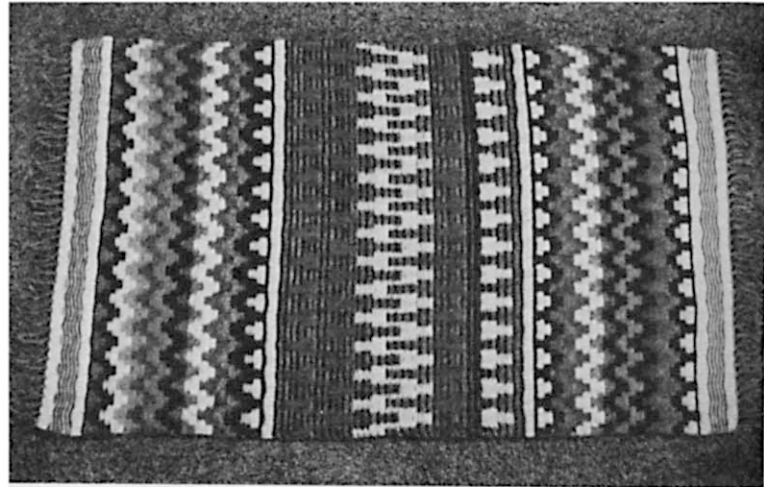

Plate 4

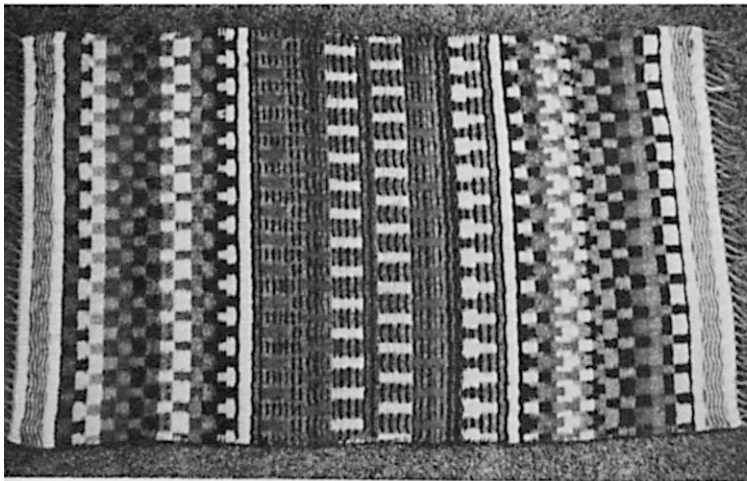

Plate 5

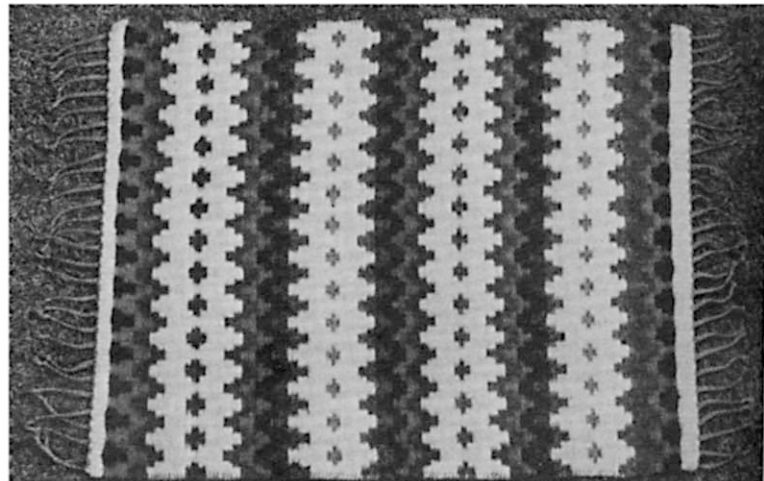

Plate 6

Plates 4 and 6 show rugs woven on a 4-harness point twill. Two warp ends are threaded on each harness to give larger and bolder patterns. See Fig. 4.

In this threading, only three colors out of the 4-shed sequence appear on the surface as vertical color columns. In the fourth shed the weft pick is completely hidden behind the other picks and appears only on the reverse side of the rug. In the same manner, in the second shed, the weft pick appears only on the front side of the rug. See Fig. 5.

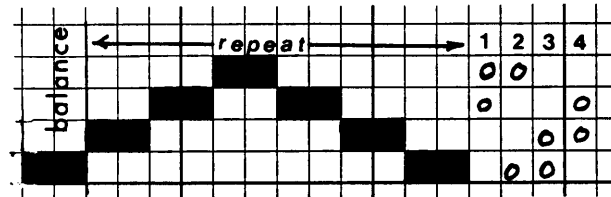

Fig. 4

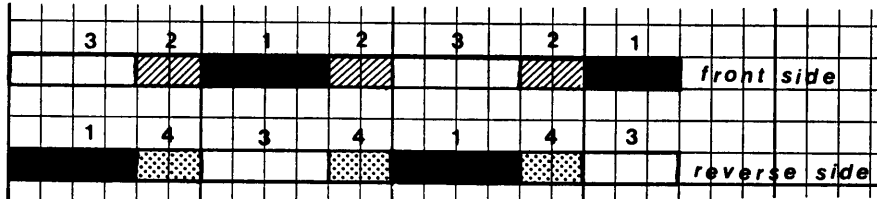

Fig. 5

By controlling the color of the fourth shed (treadle 4), many variations of patterns can be designed on the reverse side of the rug; this makes the rug completely reversible.

Plate 5 shows the reverse side of rug shown in Plate 4. The rug in Plate 6 was inspired from the design that appeared on the reverse side of the rug shown in Plate 5.

The rugs shown in Plates 4, 5, and 6 were woven on the draft shown in Fig. 4. There are 12 ends in each repeat.

WARP: 8/3 linen.

WEFT: Cretan homespun from Stavros Kouyoumoutzakis, heavy weight.

Single ply wool and cow hair blend from Gustaf Werner of Sweden.

SETT: Rug #4 and 5, 5 e.p.i. (20/10cm).

Rug #6, 6 e.p.i. (24/10cm).

THREADING: 14 repeats plus 2 warp ends to balance the pattern.

WIDTH IN THE REED: Rug #4 and #5, 34" (85cm). Rug #6, 28" (71cm).

Two warp ends are added on each side for floating selvages.

Fig. 6 shows how the color appears on the surface to create patterns.

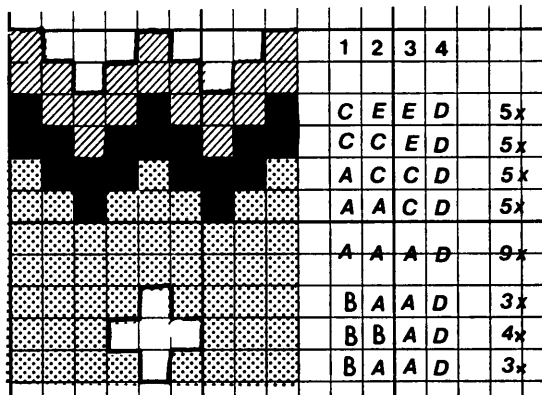

Fig. 6

The Weaver's Journal

SHOP OWNERS

To sell single issues of "The Weaver's Journal" write to:

"The Weaver's Journal"
2950 Pearl Street
Boulder, CO 80301

Rugs Based on Four Harness Twills

Twills offer a large array of design possibilities for rugs. Fig. 1 shows the different twill threadings used in the rugs that were woven for this article.

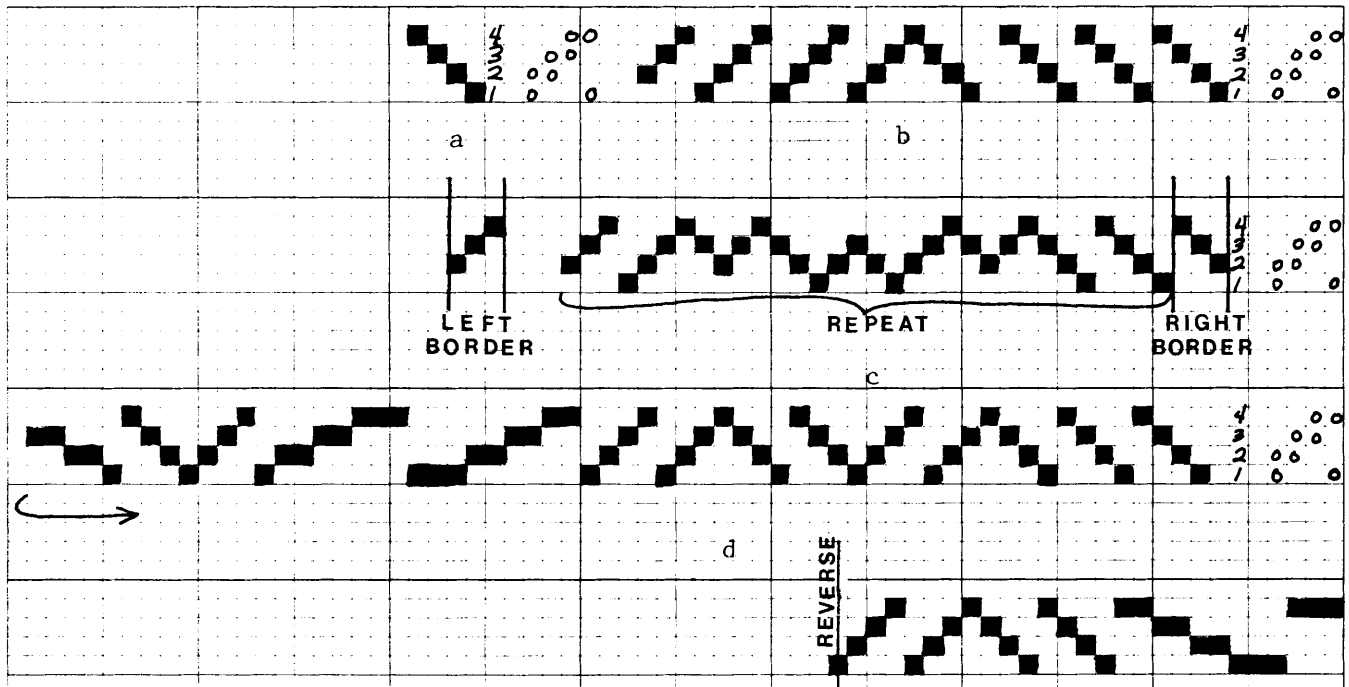

Fig. 1

1a is a straight draw, 1b is a point twill, 1c is an extended point twill and 1d is an undulating twill. All rugs are woven with the standard twill tie-up.

A floating selvedge was used for each project. The Damascus edge was chosen as weft protector and the fringe was then tied with overhand knots.

The plain twill threading is best if one wants to experiment with variations in color pick sequences. The samples illustrated in plates 1 through 4 are all woven on the same warp, threaded on a 4-harness straight draw, as in Fig. 1a.

WARP: 3/2 cotton.

WEFT: Cretan natural sheepswool from Stavros Kouyoumoutzakis. This a coarse single-ply relatively thick wool.

SETT: 5 e.p.i. (20/10cm) in a 10 dent (40/10cm) reed. The first and last two warp ends are sleyed in adjacent dents of the reed.

"Canadian readers of The Weaver's Journal will be interested to know that LILLSTINA Weaving Looms 28", 40" and 46" weaving widths, Table-loom 20" and 25" and a wide range of handweaving accessories including unusual items such as nap-raising Teazle Strikes are available exclusively from CREATIVE CRAFTS, 4 John Street, Weston, Toronto, Ont M9N 1J3. Free catalogues and price-lists on request".

Sample I - Plate 1

The treadling is 1-2, 2-3, 3-4, 4-1, which has been repeated and also reversed. The diagonal lines are obtained by weaving a pick in color A, then 2 picks in color B. This is the 2-color sequence ABB. A complete sequence in which all 4 sheds and all colors have been rotated will take 12 picks.

Sample II - Plate 2

The treadling is 1-2, 2-3, 3-4, 4-1, repeat. The pattern is derived from the basic 2-color sequence, AAAAAABAABBBBAAB. Some bands are in white and grey, some in black and grey and some bands involve all three colors in the sequence such as: Bl, Bl, Bl, Bl, Bl, Gr, Bl, Bl, Wh, Wh, Wh, Wh, Bl, Bl, Gr.

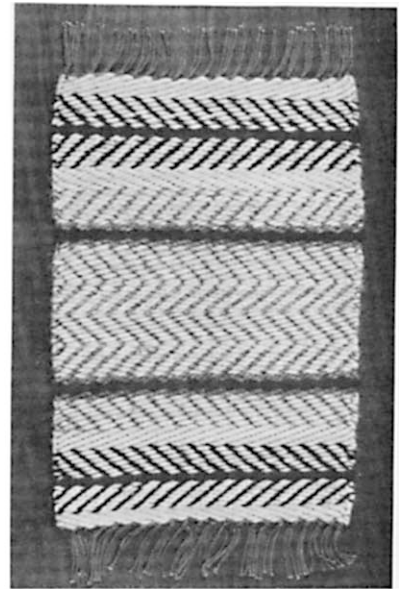

Plate 1

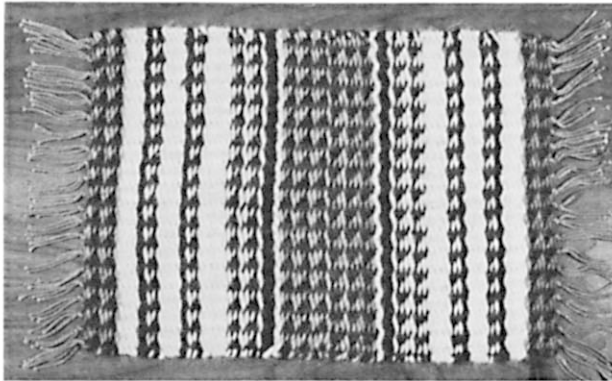

Plate 3

Sample III - Plate 3

The plain bands are treadled 1-2, 2-3, 4-1, 3-4. This broken twill treadling obscures the twill lines in the rug. The patterned bands are treadled 1-2, 2-3, 3-4, 4-1, in the color sequence ABBAABAAABBB. Some bands are grey and black, some are white and black.

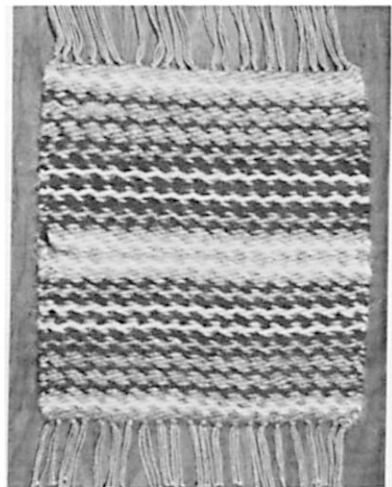

Plate 2

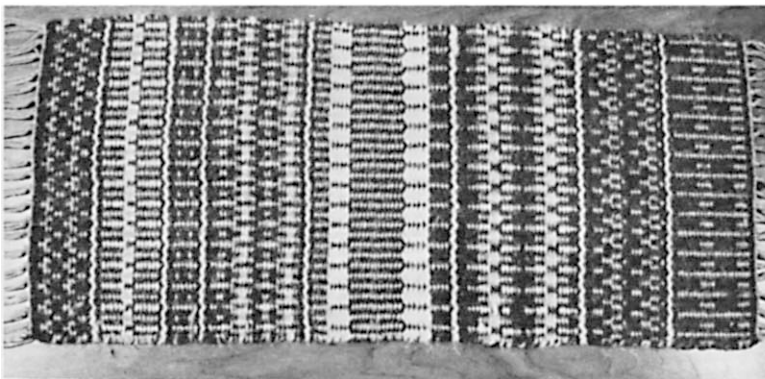

Plate 4

Sample IV - Plate 4

This is a sample of Swedish Krokbragd, which can be woven on a 3-harness point twill threading or a 4-harness straight draw.

Fig. 2 shows the draft for each set-up. The weft is harder to beat in than with 2/2 twill rugs and a sett of 4 e.p.i. (16/10cm) may be necessary with some weft yarns. The weave structure has the appearance of plain weave on the front side of the rug and has floats on the backside. The rug sample is woven in bands of the following color sequences:

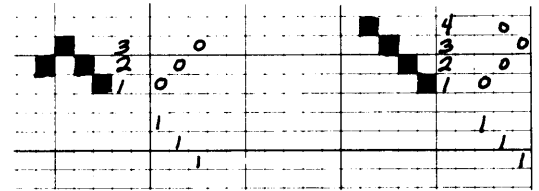

Fig. 2

1. AAB, AAB, BAA, BAA, ABA, ABA; repeat.
2. ABC 6x, CBA 6x; repeat.
3. AAB, ABB, AAB; repeat.
4. AAB, AAB, ABC, ABC, AAB, AAB, BAA, BAA, CBA, CBA, BAA, BAA; repeat.
5. ABB 5x, CCA 5x, ADD 5x.
6. AAA, AAB, AAB, AAB, ABC, ABC, ABC, BCA, BCA, BCA, ABC, ABC, ABC, AAB, AAB.
7. AAA, AAB, AAB, AAB, ABA, ABA, ABA, BAA, BAA, BAA, ABA.
8. AAB 8x, ABB 5x, AAB 8x, ABB 5x.

Sample V - Plate 5

This is also woven on the draft in 1a but the weft is a novelty acrylic. The color sequence is given below:

1-2	2-3	3-4	4-1		
A	A	A	A	3x	
A	A	A	B	3x	
A	A	B	B	3x	
A	B	B	B	3x	
B	B	B	C	3x	
B	B	C	C	3x	
B	C	C	C	3x	
C	C	C	D	3x	
C	C	D	D	3x	A Green
C	D	D	D	3x	B Grey
D	D	D	A	3x	C Dk. Grey
D	D	A	A	3x	D Brown
D	A	A	A	3x	

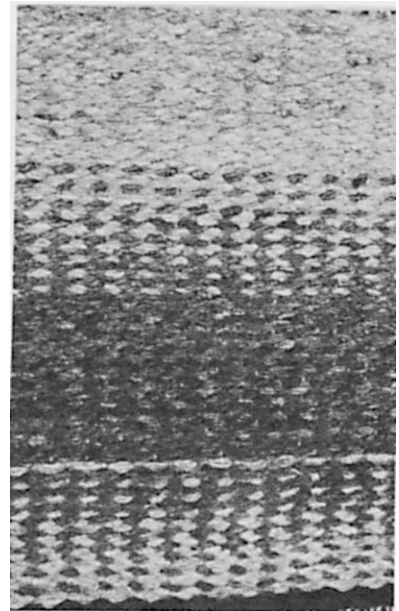

Plate 5

1977 CRAFT AND FOLK ART TOUR of JAPAN

Visit weavers, potters, papermakers, and other craftsmen.

See the folk arts and crafts of OLD JAPAN with Yoko Harrold and Mary Lou Maxson.

FOURTH ANNUAL TOUR - OCTOBER 13 to November 2

For folder, write to:

JAPAN CRAFT AND FOLK ART TOURS

P.O. Box 4116 Boulder, Colorado 80306



The rugs illustrated in Plates 6 through 10 are woven by the staff of "The Weaver's Journal".

Rug I, Plate 6, draft given in Fig. 1a.

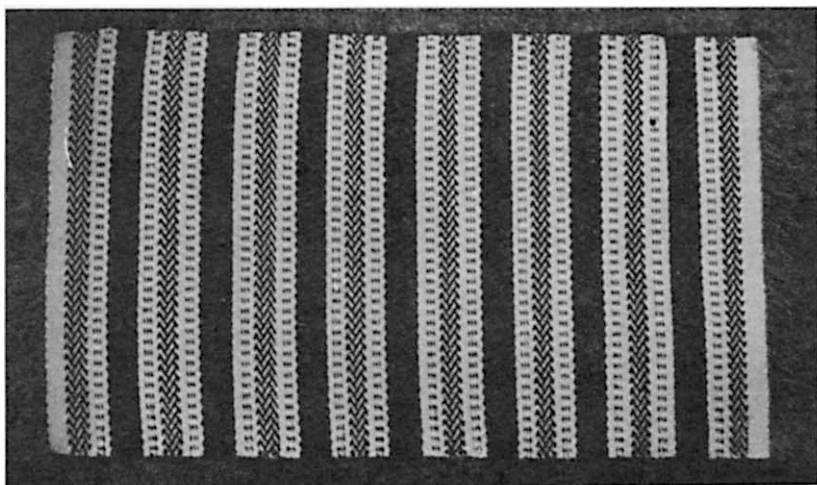

Plate 6
Twill Rug woven by
Iris Richards

WARP: 8/3 linen from Gustaf Werner, Inc., used twofold.
WEFT: Mule spun wool from Henry's Attic in white, gold and seal brown. (The yarns were dyed with Cushing dyes).
SETT: 5 e.p.i. (20/10cm)
WIDTH IN THE REED: 40" (100cm).
TREADLING: 1-2, 2-3, 3-4, 4-1; repeat.
Color sequence for the brown and white bands: ABABA.
Color sequence for the gold and brown bands: AABBAAB.
Color sequence for the gold and white bands: AAAB.

Rug II, Plate 7, draft given in Fig. 1a:

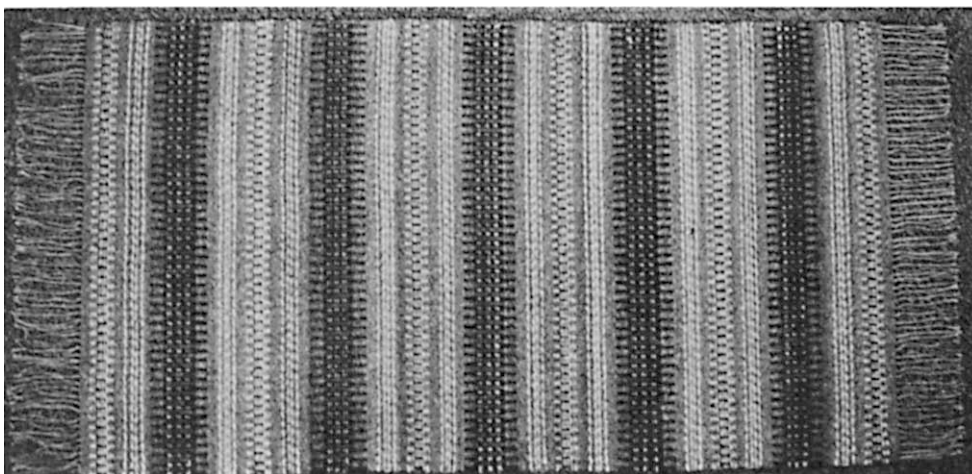

Plate 7
Twill Rug
woven by
Maxine Wendler

WARP: 8/3 linen from Gustaf Werner, Inc.
WEFT: Cretan natural sheeps wool from Stavros Kouyoumoutzakis in white, grey and dark.
SETT: 5 e.p.i. (20/10cm) in a 10 dent (40/10cm) reed. First and last two ends are in adjacent dents.
WIDTH IN THE REED: 40" (100cm).
LENGTH ON THE LOOM: 64" (163cm).
FINISHED SIZE AFTER DRY CLEANING: 35" x 62" (89 x 158cm) plus fringe.
TREADLING: 1-2, 2-3, 4-1, 3-4; which is called broken twill treadling.

The rug consists of plain bands and stripes and of bands with variations of the design shown in Fig. 3.

The color sequences for the different sections of Fig. 3 are:

Section 1	CCCC	Section 4	BBBC
Section 2	BCCC	Section 5	ABBC
Section 3	BBBB	Section 6	BAAA

Fig. 3

Rug III, Plate 8, draft given in Fig. 1a.

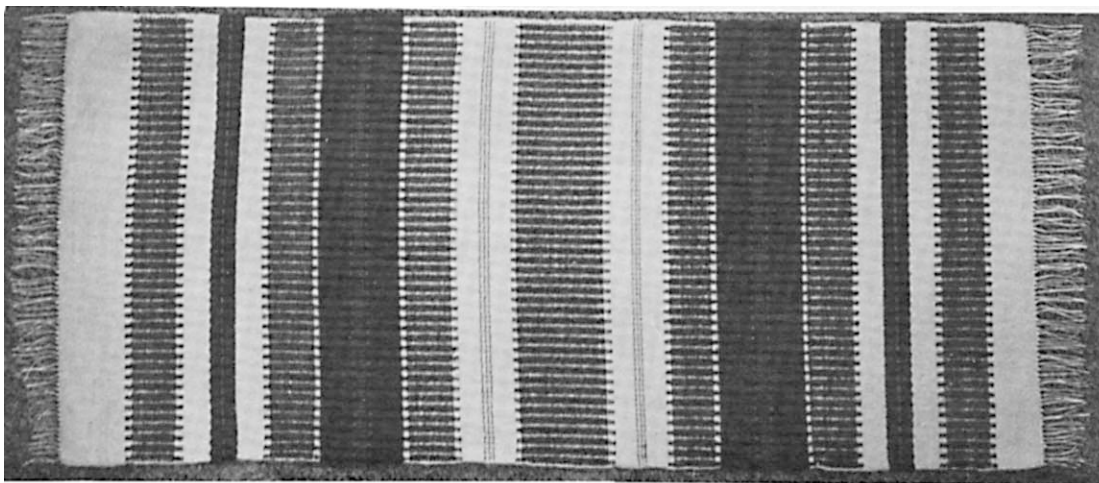

*Plate 8
Twill Rug
woven by
Willy Bottema*

WARP: 12/12 Fiskgarn from Gustaf Werner, Inc.

WEFT: Miscellaneous rug wools in white (A), medium brown (B), golden brown (C), dark brown (D), and rust brown (E).

SETT: 5 e.p.i. (20/10cm).

WIDTH IN THE REED: 36" (90cm).

TREADLING: 1-2, 2-3, 3-4, 4-1.

The rug consists of plain bands in colors A and E and bands with the following color sequences: AAAB, AB BB, ABBC, CCCD.

Rug IV, Plate 9, draft given in Fig. 1c.

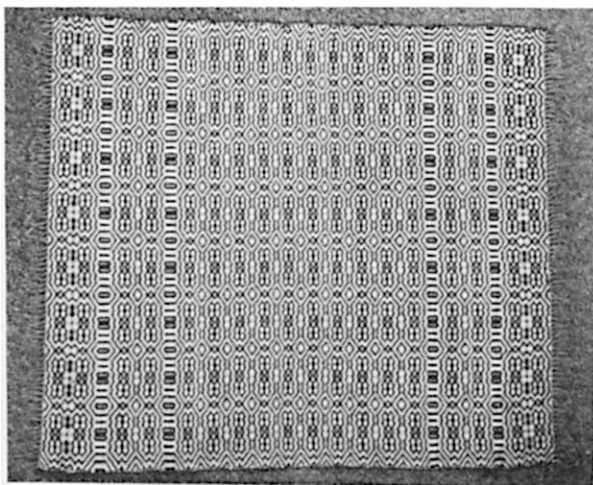

*Plate 9
Twill Rug woven by Clotilde Barrett*

WARP: 8/3 linen from Gustaf Werner, Inc.
 WEFT: 3ply rug wool from Henry's Attic in fawn and white.
 Cretan natural sheeps wool from Stavros Kouyoumoutzakis dark.
 SETT: 6 e.p.i. (25/10cm).
 WIDTH IN THE REED: 44" (105cm).
 TOTAL NUMBER OF WARP ENDS: 263, which gives 8 pattern repeats plus the borders.
 TREADLING: 1-2, 2-3, 3-4, 4-1; which is repeated and reversed.
 COLOR SEQUENCE: ABC.

Complete shed and color sequence:

1-2	2-3	3-4	4-1		4-1	3-4	2-3	1-2	
F	D	W	F			D	F	W	
D	W	F	D	Section I	D	F	W	D	Section IV
W	F	D	W		F	W	D	F	
4-1	3-4	2-3	1-2		1-2	2-3	3-4	4-1	
	D	F	W	Section II		D	W	F	Section V
D	F	W	D		D	W	F	D	
1-2	2-3	3-4	4-1		4-1	3-4	2-3	1-2	
	W	F	D	Section III		F	W	D	Section VI
W	F	D	W		F	W	D		

For the first and last band:

Sections I (2x), II, III, IV, V, VI, I, II, III, IV (2x).

For the middle bands:

Sections I (2x), II, III, IV, I, II, III, IV (2x).

Rug V, draft given in Fig. 1b has been described in *"The Weaver's Journal"* Vol. I/1, pp. 22-24.

Rug VI, Plate 10, draft given in Fig. 1d.

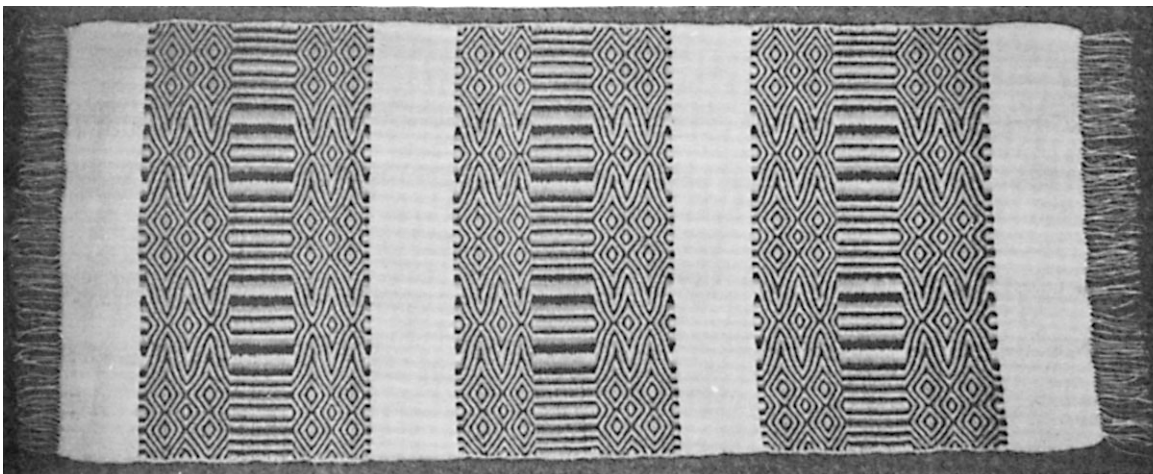

Plate 10
 Twill Rug
 woven by
 Willy Bottema

WARP: 12/12 Fiskgarn from Gustaf Werner, Inc.
 WEFT: 3 ply rug wool from Henry's Attic, white and fawn.
 Cretan natural spun from Stavros Kouyoumoutzakis in dark.
 SETT: 5 e.p.i. (20/10cm).

WIDTH IN THE REED: 36" (90cm).

TREADLING: 1-2, 2-3, 3-4, 4-1, which is repeated and reversed.

The rug consists of plain bands and of bands with the color sequence ABC:

1-2	2-3	3-4	4-1		4-1	3-4	2-3	1-2	
A	B	C	A		*C	B	A	C	
B	C	A	B	3x	B	A	C	B	3x
C	A	B	C		A	C	B	A	

* Omit 4-1, color C on the first repeat.

Book Reviews

by Clotilde Barrett

THE TRADITIONAL MOROCCAN LOOM by Carol Fillips McCreary. Tresh Publications, Santa Rosa, California, 1975, 71 pp. \$2.50.

The home-built vertical loom, suitable for weaving large tapestries and rugs, has recently become very popular with weavers. Often an artist adapts ethnic looms to his own weaving requirements; for him the Moroccan loom will be a new source for ingenious ideas. In this small book the reader will find a wealth of information on the Moroccan loom with complete instructions for building the loom, dressing it, and weaving. Each step is described in detail and is illustrated with clear drawings.

This book is well done and should be in the library of all who are interested in textiles.

* * *

ENCYCLOPEDIA OF HAND-WEAVING by Stanislaw A. Zielinski. Funk & Wagnalls, New York, 1975, 190 pp. \$4.95.

This concise encyclopedia was first published in 1959 and was sorely missed by many weavers when it went out of print. I am happy to see this book reappear on the market in affordable paperback form. It is a great reference book. One could almost call it a classic even if once in a while the information lacks accuracy: e.g. "Navajo Weaving: The only weave used is tabby, and since vertical lines are avoided, there are neither slits nor interlocking. Patterns are simple, geometrical. The material used has been cotton and after the arrival of Spanish colonists, wool as well." The author was misinformed and one must regret that this last edition has not been revised. Nevertheless, this encyclopedia contains an abundance of information that is useful to the textile craftsman and almost unavailable in other weaving texts. The names and words are in alphabetical order with cross references to related terms and synonyms. The information on each subject is concise but yet detailed enough to answer most of the reader's questions.

* * *

WEAVING - DESIGN AND EXPRESSION by Nancy Belfer. Davis Publications, Inc., Worcester, Massachusetts, 1975, 159 pp. \$12.95.

This book ought to be picked up by a person interested in fiber arts who has had little exposure to textiles or by the beginning weaver who is knowledgeable

of basic techniques but who is looking for new approaches to creative weaving. Many books published in recent years are geared toward that same audience, but, while most of these try to cover all textile techniques, the author limits this book to weaving, with a short chapter on rug hooking. The book starts out with some historical notes on Coptic and Peruvian textiles. The chapter on fibers, yarns, tools and equipment will be very helpful to beginning weavers. The weave structures discussed are very basic but lend themselves best to creative expression with simple tools. The author makes a good presentation of available looms, from a simple notched piece of cardboard to the horizontal treadle loom.

The scope of the book is extensive and therefore many topics are not handled with the depth that the subject requires. For instance, the chapter on texture and color in weaving is restricted to a few paragraphs and thus remains rather superficial. However, there are many techniques of surface embellishments and three-dimensional effects that should stir the imagination of any reader.

Greater care should have been taken to avoid inaccuracies in this book. For instance, the one bar loom used by the Chilikats is cited as an example of a weighted warp loom. The skin pouches which protect the free hanging warp were apparently mistaken for weights.

The book is abundantly illustrated with clear drawings, which should encourage anyone who loves fibers to start winding a warp and interlacing it with sensuous weft yarns. The photographic illustrations should have been restricted to the better works only.

* * *

CARD WEAVING by Ruth Katz. Van Nostrand Reinhold Co., New York 1977, 152 pp. \$12.95.

My very first reaction to the book is to wish that some chapters were longer, more encompassing, while others might be shorter, dwelling less on irrelevant details.

The history of card weaving is of great interest to many fiber craftsmen and this book offers valuable and well illustrated information. One only regrets that this chapter is so short and does not go much beyond other recent publications on the same subject.

Following this historical introduction, half of the book is devoted to very elementary card weaving interspersed with a great deal of "small talk" such as where to purchase a maxi-padded cloth hanger! The instruction is detailed and easy to follow but these slow and lengthy chapters may very well discourage a potential card weaver before he gets started.

Then, suddenly, in about the middle of the book, the author becomes very brief when the more complex manipulations of cards are described. In the chapter on fancy weaves and advanced techniques, various lesser-known card weaving techniques are explained far too briefly. No instructions are given for many of the beautiful patterns shown in the illustrations. This entire section of the book should have been more detailed and comprehensive.

The following chapters are elementary again, geared to the beginning card weaver. These teach finishing techniques as well as working out elementary patterns.

* * *

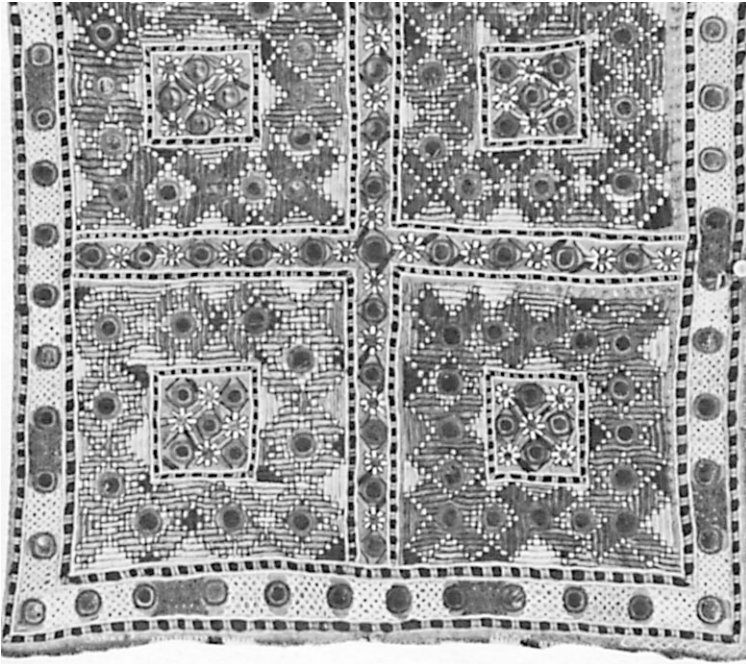

Plate 1
Embroidered Mirror Cloth, Rajasthan

Textile Arts of India

by Ronald M. Bernier

The female classical dancer in India garbed in mirror cloth (Plate 1) and the medieval sculptural image of a goddess, like the 12th century Parvati in the Denver Art Museum, are much alike in form and emotive content. They are both voluptuous and curvaceous, with the sinuous lines and breath-filled volumes of their ripe bodies emphasized and caressed by the encircling flow of graceful movement that is captured by ornament and textiles. Cloth and jewelry are mood-setting frames for the languid forms; they are as important as the figures themselves.

Calico, gingham, chintz, khaki--all are Indian terms now common in the West. The sensuality of brilliant color and dazzling intricacy of design for which the art of India is justly famous are nowhere more dramatically expressed than in the country's incredible variety of textiles. Patterns painted, printed, woven, embroidered, dyed, beaded, and mirror-sewn bring allover abstraction or narrative design to every kind of fabric. The materials are cotton, wool, satin, gold or silver tissue, velvet, chintz, brocade and silk--a palette of every hue created in multiple textures--and the fame of Indian textiles has spread to the Near East, Europe, Africa, and Southeast Asia, beginning in the third millenium B.C. The following comments, necessarily incomplete and very selective, are intended to provide an introduction to the highly complex subject of Indian textile arts.

SARIS OF GOLD

The Indian woman is an ideal fashion plate as she displays fabric arts, for she wears that most dramatic of cloth garments: the *sari*. This single cloth, generally five or six yards in length, is woven as one continuous composition with a "blouse piece" at one end and often a highly decorative wide border at the other. In most of India it is wrapped and gathered about the body at the waist, tucked into the band of an ankle-length petticoat, then draped across the front of the body over a tight-fitting short blouse (*cholie*) to be gathered at the left shoulder and finally allowed to flow long and free over the back. The cloth moves lightly behind a walking wearer--a flash of airy color--and the movement of retrieving the slipping garment just as it is about to expose the lady's bosom is both provocative and graceful.

Called India's "fabric of dreams", *kinkhab* brocade from Banaras (Varanasi) on the Ganges in North India is produced by the interweaving of colored silk with silver or gold thread. Legend has it that the mortal remains of Buddha were wrapped in this flamboyant material in the 5th century B.C. More prosaically, perhaps, its attraction was felt in this century by Queen Elizabeth II and Jacqueline Kennedy during their grand tours of India. The term *kinkhab* means literally "cloth of gold", with metallic wire having been used alone in earlier times for both warp and weft. Among types still being made are those in which gold or silver thread dominates with silk used only to outline and emphasize patterns. So heavy are these textiles, often marked by raised patterns having the appearance of metal repoussé, that they are not used for clothing but rather as hangings, curtains, and canopies. Lighter are *baftas* or *pot-thans* made of closely woven silks with mere highlights of gold or silver. Lightest of all are the brocades or silk muslins that use almost no metallic thread but which may have heavy borders sewn onto them. The remarkably fine fabrics are woven on a drawloom briefly described as follows: "...unlike the common loom in which the up-and-down motion is imparted by treadles pressed by the weaver's foot in rhythm, the special Naksha (pattern heddle) is worked from the top by a young boy seated on a crude bench situated over the weaver's head. The bar of wood held by the child is given a twist to pull up the cords attached to the warp, according to the pattern woven and which threads are to appear on the surface of the weft at any time. Sitting at the head of his loom, the weaver produces variety in the design by introducing silks of varied colours into the woof, together with the thread of gold or silver as his young apprentice watches-- and thus the vision grows in the sight of the young child seated aloft."

(Rustan J. Mehta, *Masterpieces of Indian Textiles*, p.10).

FOLK EMBROIDERY

If the silk brocade sari impresses the viewer with its unequalled sophistication, an opposite pole of design is presented by the folk-art directness of embroidery among the tribal peoples of Assam. In the Naga hills of that remote mountain state, especially with the Angami Nagas, black cotton is decorated with bold patterns of conventionalized animal and human forms in red, maroon, green, white, and yellow. The stitches are large here, as much as one-half inch long, with the silken embroideries of Shillong repre-

Plate 4
Folk Embroidery, Naga Hills, Assam.

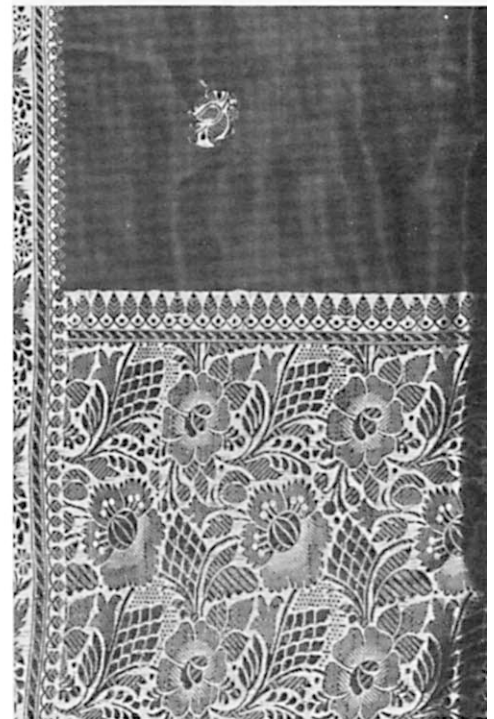

Plates 2 and 3
Silk and Gold woven Sari,
Banaras.

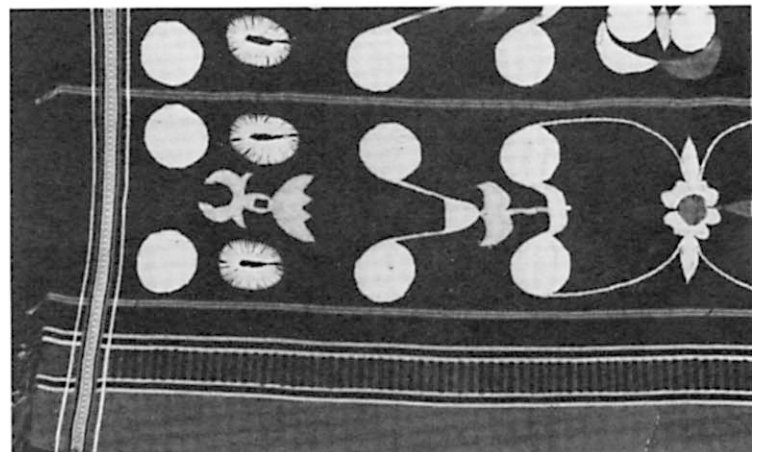

senting the finer skills of Assam. The ends of the woven cotton are tied into long, colorful fringes by the Naga Hills weavers, and individual sections of cloth may be tied together in the same flamboyant manner to make long panels. In total, the design is powerful in the contrast of brilliant hues and silhouette patterns on black field. And the weaving here is unusual for India in being an art exclusively of women. The Angami Nagas produce an entirely native textile art that is the equivalent of the indigenous, bold painting styles of medieval Gujarat and the native mountain school of Basohli painting.

PRINT, PAINT, BATIK, PLANGI, IKAT

Somewhere between the khinkhab fabric and Naga Hills embroidery in terms of intricacy of design and technique are the printed and dyed fabrics of India. These are the norm in the sub-continent. To handwoven cotton fabrics are added repeated patterns, abstract or representative, large in size or minute. The most basic technique is that employing wooden stamps carved in relief that are dipped in colored dye, then pressed onto the plain or colored cloth in regular rows. All of India utilizes this method, but its center is perhaps Jaipur. Multiple blocks may be used for elaborate results, and it is suggested that the process began in China on the basis of discoveries by Sri Aurel Stein at Tun Huang which date from the seventh century and the T'ang Dynasty (Mehta, p. 34).

The cotton cloth is washed, bleached, washed again and has been mordanted to fix the dye, traditionally with an emulsion of alum and sappan wood, applied by being brushed on or stamped. Dye-resist may also be printed on in this way. From a low position on the ground or from a low stool, the printer presses the blocks with the right hand onto felt pieces soaked with dyes and then onto the cloth. Normally the block is tapped with the left fist to darken and set the impression. The resultant designs in color may be elaborately narrative of religious story, especially in South India, but more often they present decorative designs that emphasize floral elements, the so-called Tree-of-Life, birds, and geometrical designs. Gum may be printed on to the cloth for the application of gold or silver leaf, a borrowing from Persia.

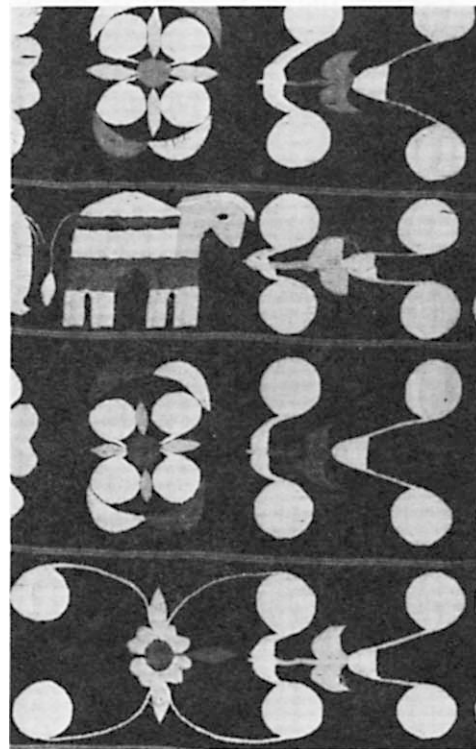

*Plate 5
Folk Embroidery
Naga Hills, Assam.*



*Plate 6
Wood Block Print on Cotton
Central India.*

Kalamkari cloth of Masulipatan began as painted calicoes but now present, as one of India's best known fabrics, a combination of painting and batik. Painting with mordants and dyes, or the application of resists is done with the simple tool called the *kalam*. For dyes which are mixed with a fixative of sappan wood and alum a piece of bamboo with nib end topped by a ball of compact hair as reservoir may be used. For the application of resist-wax before indigo dyeing an iron *kalam* with bamboo handle may be used with bulb wound with a layer of hair. Wax runs from reservoir over bulb to point. Either of the above may be replaced today by mere twigs, crushed or chewed to fiber at the end. Painted textiles are the rule for religious hangings in temples, but secular saris and other ordinary cloths are also treated so to the present day. Cloth painting is a source of extra income to many talented Indians of all classes.

The term bandanna, which in the West describes a large handkerchief of red or blue with white or yellow spots, is derived from the Indian term *bandhana* or *bandhani*, plangi (tie-dye work) as practiced in India since the seventh century. The technique thrives especially in Sind, Rajasthan, Gujrat, and Kathiawar. The technique involves the folding of cloth, usually very fine cotton muslin, to three or four folds thickness, wetting the cloth, and placing it on a block of wood marked with pins pounded in a regular design. Waxed thread is wound around the cloth where it is raised on the pins. The waxed ties resist the dye in the next step, dyeing, which may be repeated with various colors after re-tying. Extremely fine dots, stars, squares, and circles create the finished patterns.

More unusual to Western experience is the *ikat* dye technique wherein the warp and weft threads are tie-dyed *before* they are woven together. Precision of an extraordinary kind is required so that the finished woven design will be unified and exact. The puzzle must assemble perfectly. In India *patrola* fabrics are the best known of this type, being especially preferred for the silk wedding saris of Gujarat and Kathiawar. The technique may be fifteen hundred years old and it is followed today also in Indonesia (the term *ikat* is Indonesian) as one result of Indian trade contacts.

More important to the study of textiles than details of technique and geographical distribution is an understanding of the Indian aesthetic in general; the concern with expressive color and luxurious, succulent forms that speak of fertility and sensuality as gifts to life that beauty is goodness and abundance is reward to the faithful. Unbleached, unsewn garments are humble, holy, and pure, but the enjoyment of life demands *color*, whether in the flying powders of the spring Holi festival or the sequined wrap of the Hindu bride. Palms and soles of the feet are painted red for beauty, spots of white glimmer on the faces of brides and grooms, sacred images are smothered in rainbow petals and sprinkled with brilliant pigments along with rosewater. The air of grand shrines is perfumed and hazed with color as poets write visionary fantasies in technicolor and carpet-like pattern. And the gods have their own colors--red for Shiva the destroyer and blue for the seductive Krishna. This sensitivity to color and pattern is clearly expressed in the high development of India's textiles as one of the world's most fully developed traditions of this art.

The following words belong to the classic *Shakuntala*:

"A heavenly future waits for you.
Your life, shall sail, a fairy tale,
beneath a sky forever blue."

SHAWLS OF KASHMIR

Shed, at the coming of summer, is the fine fleece of the under-belly of the wild Asian mountain goat (*Capra hircus*). The wool is gathered from the brambles and shrubs where the animals rub it from their bodies and used to produce *pashmina*, the cloud-soft and lightweight wool that produces "ring shawls" fine enough to be drawn through a man's ring. The custom of wearing such shawls over the shoulders, followed by both men and women, possibly began in India. The making of the garments is most highly developed in the mountain regions of the northwest. Regional styles are many in the Pahari or hill regions, including Kulu, Kangra, and Chamba, but unquestionably the finest and best known shawls are those of Kashmir.

The *kanikar* (tili) shawl of Kashmir presents decorative patterns that are woven on the loom itself in a twill-tapestry technique that is very similar to that which produces western tapestry. The loom is of simple horizontal type with the design formed entirely by the weft threads as they are interwoven with the warp threads wherever color is needed. Seven specialists are normally active in the total procedure, with the Naqqash or pattern maker creating a design that is called out by a Tarah-guru or color-teacher who directs the weaving of color picks from the bottom upwards. The work is done by men and the positions are mostly hereditary. The shawls became so intricate about two hundred years ago that several looms began to be used to produce simple shawls that were assembled from several parts.

Rustan J. Mehta defines the parts of the embroidered shawl, masterwork of Kashmiri art, as including the *hashiya* or border that runs the full length of the shawl, the *phala* or embroidery at the two ends with *tanjir* or chain stitch embroidery above or below, the *kunj butta* or corner decoration (usually flower clusters), and the *mattan* which is that general part of the field that is ornamented with embroidery (Mehta, p. 18).

Embroidery is a living art in Kashmir, as sought after today as in the time of the Moghul emperors. After the woollen cloth has been placed on a wooden plank and rubbed very smooth with a piece of agate or carnelian, a drawing on paper is placed over the wool. The drawing is then outlined by pinpricks through which pulverized charcoal is pounced



Plate 7
*Namdah Pressed Wool Rug with
Embroidery, Kashmir.*

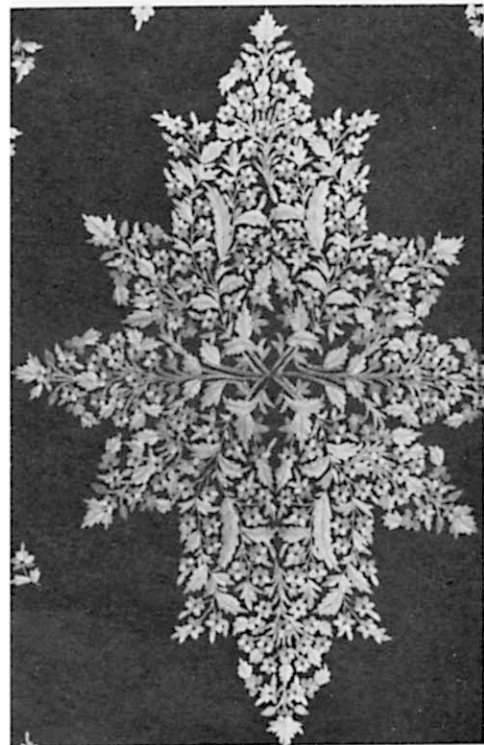

Plate 8
Embroidered Wool Shawl, Kashmir.

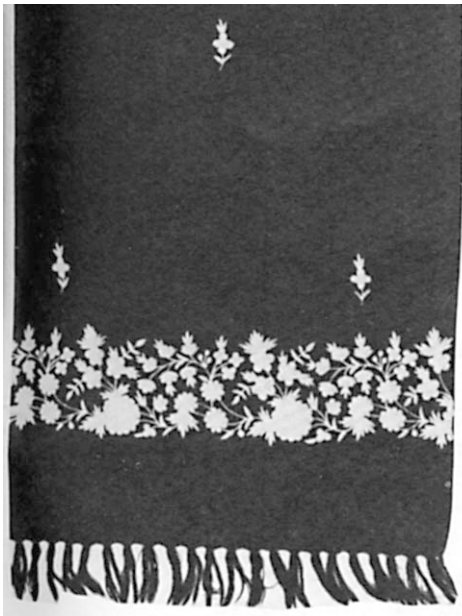

Plate 9
Embroidered Wool Shawl, Kashmir.

or stencilled. The embroidery stitches are of parallel darning type and the pashmina fabric is so finely textured that the finished surface design appears almost to have been woven on the loom. The warp thread is picked up by the embroiderer and the stitch is preferably not allowed to pass entirely through the shawl (Emperor Akbar is said to have begun the tradition of weaving shawls in pairs sewn back to back, *do-shala*, so that the undersides would never be seen).

The decorative designs of Kashmir shawls are almost always floral, reflecting the Islamic heritage of their makers, whereas the Hindu epic of the *Mahabharata* or Krishna devotional story are appropriate to the *rumal* embroidery of remote Chamba, complete with active scenes of gods and men. Such anthropomorphic imagery is strictly forbidden in Muslim Kashmir. And so floral, vegetal, and (more rarely) animal and bird patterns are found, with the most common design being that of the elegant leaf of the Chenar tree. Colors of the wool are limitless, with emphasis on various reds, greens, purples, black, and white, and the embroidery is of *pashmina* or other wool with some use of silk, gold, and silver. While men's shawls have little or no decoration, women's designs vary from the fairly restrained border patterns described above to an all-over explosion of color and fine line like a poetically flower-strewn sky.

PAINTED CHINTZ

Perhaps the most visionary of Indian textile designs is that of painted chintz, named for the Indian *chhint* (painted cotton) from the verb *chhintna* (to sprinkle or bespatter). While the art, as discussed by Veronica Murphy of London's Victoria and Albert Museum, is hardly purely native but "an amalgam of Persian, Indian, European, Chinese, and Chinoiserie elements", it nonetheless represents a major exchange between South Asia and Europe in the 17th and 19th centuries.

Design outlines were again transferred by a pouncing stencil method, but freehand copying was also practiced and the completion of highly colorful, usually intertwined flower and tree patterns always left room for individual invention. European pattern books were employed in the 18th century, often suggesting Dutch still-life painting, yet a harmonious synthesis is made of Eastern and Western elements.

The process of preparing chintz ends with bleaching, starching, beating, and "chanking" (being rubbed with shell to achieve surface sheen) and the application of gold or silver leaf as well. But all of this is preceded by the following preliminary steps:

1. Soaking the half-bleached cloth in a fatty astringent solution.
2. Beating it to smooth the surface for painting.
3. Applying the outlines of the design.
4. Drawing over these outlines with mordants (acidic solutions needed as fixing agents for certain colours).

5. Immersion in a red dye bath (in chay, the Indian madder) to deepen the black outlines and develop the red.
6. Waxing the whole cloth except the parts to be blue or green.
7. Immersion in an indigo bath for blue and its variants.
8. Reserving with wax the details which were to be left white in an area of red.
9. A second mordanting for fixing red tones (pink, red, violet).
10. A second red bath.
11. Application of yellow (tumeric-saffron) with a brush, to the parts intended to be yellow, over blue to make green, and over red to make orange.

(Veronica Murphy, *"Chintz - A Revolution in Taste"*, p. 40.

Through East India Company trade, this art was made known to the British Empire and the world as well as to English drawing rooms. And if the poetic philosophies of the Oriental realm were largely misunderstood during the early days of trade, the technical mastery of India, at least, was much appreciated.

THE STATE OF THE ART TODAY

All of the textile arts continue to be practiced today and hundreds of other traditions are to be found all over India. The country's museums, such as the crafts museum in the capital, give prominent placement to these accomplishments. Major exhibitions have been held abroad, including one at the Museum of Modern Art in New York. The luxuriant cocoon of cloth that envelopes the Maiden in the Guler school painting (illustrated in Plate 10) is still admired and desired in the streets of New Delhi. All over India the production of fine textiles continues, especially in the home, and a network of government-sponsored cottage industries trade outlets supports this production in even the most remote regions. The Cottage Industry Emporium is a viable feature of the market place in any sizeable town, and the quality of handworked fabric is much appreciated in the circles of fashion. Textile mills have not supplanted the trained hand and eye.

And so the living textiles of India continue as an unbroken lineage born in the ancient past, a heritage known to Babylon, the Moghuls, the Portuguese, Dutch, French, and British. With a caste system that encouraged specialization and the furtherance of hereditary skill, the Indian people took textiles to new and creative heights of elaboration and sophistication without losing their folk art heritage of direct, bold statement of form and color. Clearly, Indian textiles have a very special place in the history of world art.



Plate 10
*"The Huntress", Miniature Painting,
 Guler School. 19th c. (?)*

SELECTED SOURCES

- Irwin, John and Margaret Hall. *Indian Painted and Printed Fabrics*, Ahmedabad, 1971.
- Mehta, Rustan J. *Masterpieces of Indian Textiles: Hand Spun - Hand Woven - Traditional*, Bombay, 1970.
- Murphy, Veronica. "Chintz - A Revolution in Taste", *The Times of India Annual 1970*, Bombay, pp. 39-48.
- Museum of Modern Art. *Textiles and Ornaments of India - A Selection of Designs*, New York, 1956.

(Note: Dr. Ronald Bernier is Associate Professor of Art History at the University of Colorado in Boulder. He will lead his third annual art history study program in India during December and January).

Weaver's Market

HARD-TO-FIND EQUIPMENT. Yardage counters to accurately measure yarn, electric bobbin and spool winders with smooth operation, hand winders that hold spools, metal temples from 8" to 65", spool and cone stands, and the unique COLUMBINE spinning wheel. Free catalog. Columbine Machine Shop, 1835 South Acoma Street, Denver, Colorado 80223.

VIRGIN MERINO FLEECE \$13 per 10 pounds delivered. Fine natural color mohair yarn \$6 pound. Wool cards \$9 pair delivered. Gorgeous pure silk scarves yard square \$4. Strands of coral, turquoise, abalone, amber, all semi precious stones. Bead cord. Leathers. Seashells. Harris Tweed Sportjackets. Catalogue. Freedport Box 394, Alburquerque, New Mexico 87103.

SUMMER AND WINTER - TECHNIQUES AND VARIATIONS by Annis W. Jefferson. Booklet of 28 pages giving instruction for four to eight-harness methods. Threadings and treadlings in multi-harness which are not usually found in weaving books. \$3.00 postpaid. Order from: Annis W. Jefferson, 3716 Westcliff Road, South, Fort Worth, Texas 76109.

List of Advertisers

Bradshaw Manufacturing Co. back cover	Kouyoumoutzakis, Stavros p.2
Broadway Yarn Co. back cover	Ramus, Katherine p.2
Greentree Ranch Wools p.16	Weavers' Loft p.2
Japan: Craft & Folk Art Tour p.25	The Weaver's Shop back cover
The Jute Box back cover	

In contacting any of these advertisers, please mention that you saw their ad in "*The Weaver's Journal*".

BRADSHAW MANUFACTURING COMPANY.
 P. O. Box 425
 West Columbia, S. C. 29169

TELEPHONE (803) 794-1151

LOOM REEDS All reeds are made to customers order.

For the past 45 years our reeds has been in use by hand weavers in most every city and village throughout this country by people weaving all kinds of fine cloth.

Colleges, Loom Makers, Hand Weaving Supply Stores write for our price list on quantity orders.

HOW TO ORDER YOUR REED. . .

1st. Dents Per Inch, 2nd. Overall Length, 3rd. Inches High Outside.

MINIMUM PRICE PER REED \$9.00

From 4 dents per inch up to 25 dents.

4 INCHES HIGH OUTSIDE 33½¢ PER RUNNING INCH
 4¼ INCHES HIGH OUTSIDE 34½¢ PER RUNNING INCH
 4½ INCHES HIGH OUTSIDE 35½¢ PER RUNNING INCH
 4¾ INCHES HIGH OUTSIDE 36½¢ PER RUNNING INCH
 5 INCHES HIGH OUTSIDE 37½¢ PER RUNNING INCH
 5¼ INCHES HIGH OUTSIDE 38½¢ PER RUNNING INCH
 5½ INCHES HIGH OUTSIDE 40½¢ PER RUNNING INCH
 6 INCHES HIGH OUTSIDE 41½¢ OER RUNNING INCH

Earthy Versatile Yarns

Handweaving, Craft, Macrame

SUPERCORD 16 Warm and Vibrant Tones & Textures, Man Made Fibers, 4 Ply, 7 mm, 105 yds/lb.

EARTHSPUN 14 Earthy Natural Colors & Textures with the easy care and Benefit of Polyester, 3 Ply, 580 yds/lb.

MOONGLOW 16 Warm and Vibrant Tones & Textures with the easy care and Benefit of Man Made Fibers, 2 2 Ply, 420 yds/lb.

SEND \$1.00 FOR COLOR CARD
 AND NAME OF YOUR NEAREST DEALER

DEALER INQUIRIES INVITED

BROADWAY YARN CO.

PO Box 1467 919/775-3922
Sanford NC 27330

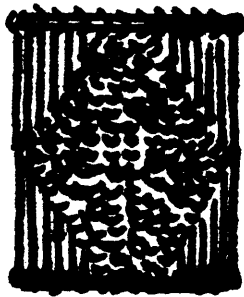

*The
Jute
Box*

• BATHIK • BASKETRY

• SPINNING • WEAVING • MACRAME

is moving to
 DURANGO, COLORADO

Address communications
 to: P.O. Box 1533
 Estes Park, CO 80517

summer hours:
Monday — 10 —
Saturday 5:30

• BEADS • LOOMS • BOOKS •

we've got it all

Imported & Domestic Yarns

Fine Looms & Accessories

Spinning Supplies

Special Summer Workshops

Books & Novelties

Quick Mail Order Service

The Weaver's Shop

39 COURTLAND STREET • ROCKFORD, MI 49341