

MEGGY JR RGB

- LED MATRIX GAME DEVELOPMENT KIT -

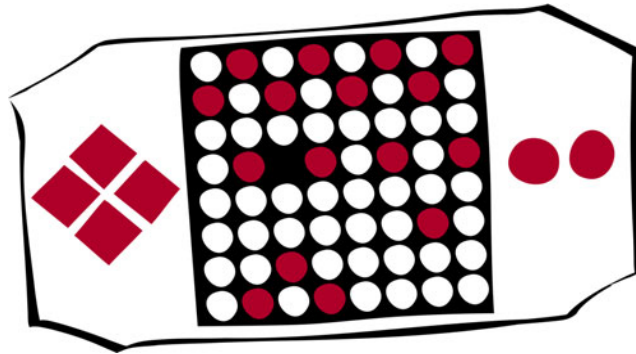

AN OPEN-SOURCE HARDWARE+SOFTWARE PROJECT DESIGNED BY

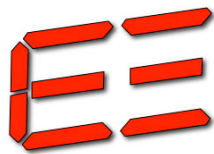

Evil Mad Scientist Laboratories

Making the World a Better Place, One Evil Mad Scientist at a Time

SUPPORT: [HTTP://WWW.EVILMADSCIENTIST.COM/FORUM/](http://www.evilmadscientist.com/forum/)
DOCUMENTATION: [HTTP://WIKI.EVILMADSCIENCE.COM/MEGGYJRRGB](http://wiki.evilmadscience.com/meggyjrrgb)



DISTRIBUTED BY
EVIL MAD SCIENCE LLC
[HTTP://EVILMADSCIENCE.COM/](http://evilmadscience.com/)

KIT VERSION 1.3
MANUAL V. 1.3A

Meet Meggy Junior!

Meggy Jr RGB is a handheld platform for developing your own pixel-scale video games. Meggy Jr has an 8x8 LED matrix display, six comfy buttons, a noise making device, and even 8 extra LEDs for whatever you like. Meggy Jr can run on batteries or external power. Meggy Jr is fast, programmable, open source and hackable.

Meggy Jr is here to play.

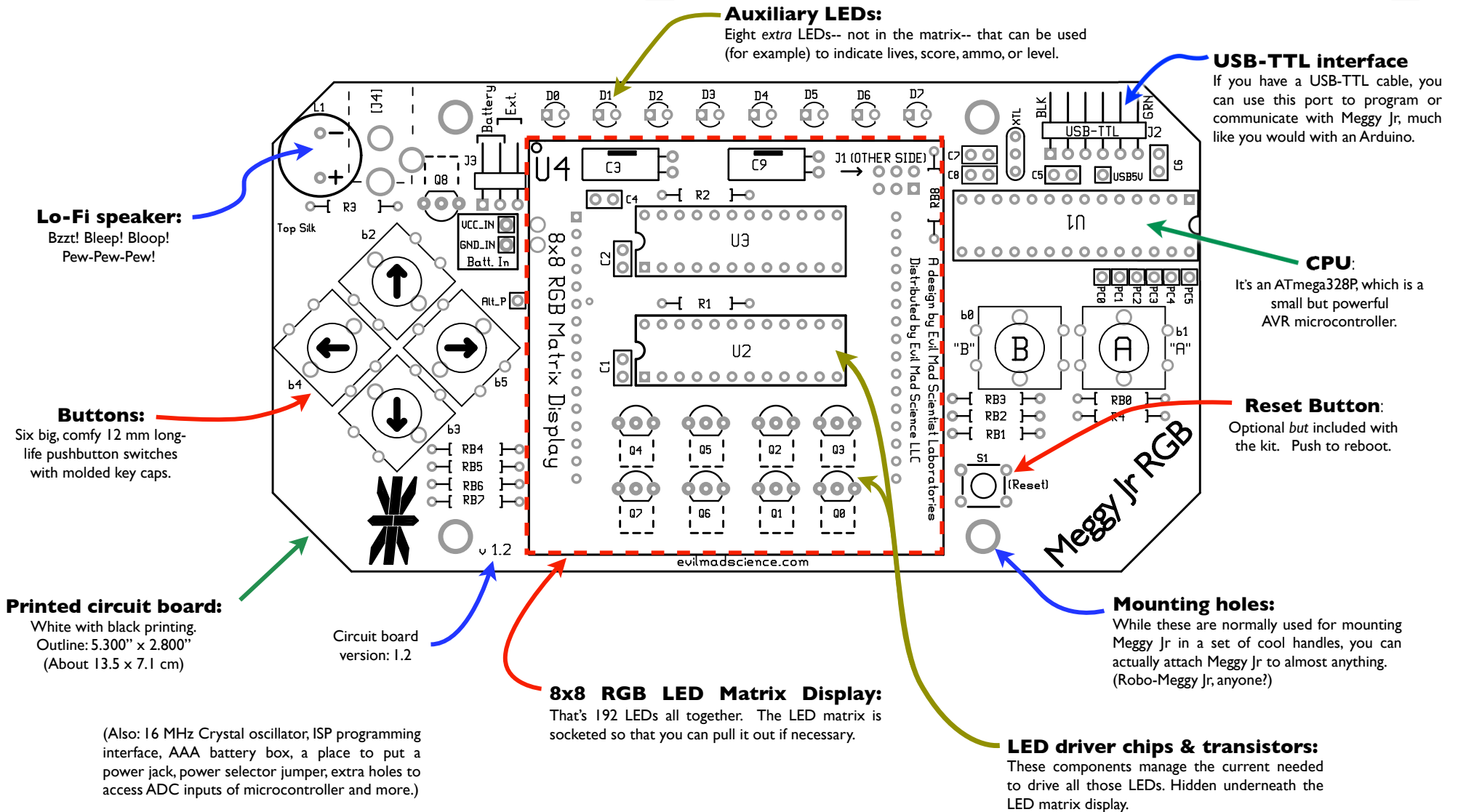

STEP 1: TOOL CHECKLIST

Essential tools: Needed to build the kit:

1. Soldering iron + solder



A basic soldering iron meant for electronics, with a reasonably fine point tip. We recommend one of this design-- a "pencil shape" soldering iron (not gun!) with a base that holds the iron and a wet sponge. A tip in good condition (a "tinned" tip) should get shiny when hot-- able to melt and wet to solder.

While you don't need an *expensive* one, the iron *can* make a big difference in the time needed to build the kit. (Seriously. If you use one that is old and busted, or a \$10 radio shack iron, or that thing from the dollar store, please expect to spend at least twice as long soldering!)

Our recommendation for a low-cost iron: model WLC100 by Weller, about \$40.

You'll also need some solder. Thin rosin-core solder (roughly .020 - .040" in diameter) is the most common and best choice for this application. Either standard (lead-bearing) or newer "lead free" solder types will both work just fine.



2. Angle flush cutters

For clipping loose wire ends close to the circuit board.
e.g., Sears Craftsman

3. Small fine-point plier set

For various nimble-fingered tasks.

e.g., Sears Craftsman. The Sears Craftsman #45671 mini-plier set includes both the clippers and pliers shown here.



4. AAA batteries (3)

(Alkaline recommended.)



Optional but recommended:

1. Resistor lead forming tool

Allows fast, neat bending of resistor leads.

This one is Speedy Bend 801, Mouser part #5166-801 (~\$8).

Also now available at Evil Mad Science



2. Wire strippers

There's one place near the end of the build where it's convenient (but optional) to shorten and strip two wires. This model is our favorite: Ideal T-Stripper #45-121 (the 14-24 gauge size).

And for Programming...

Reprogramming Meggy Jr is not required, but if you wish to do so, you'll need some things:

1. USB-TTL Cable



FTDI model TTL-232R or equivalent. A "smart" converter cable with a USB interface chip inside. One end hooks up to your USB port, the other to Meggy Jr. This allows you to program Meggy Jr through the Arduino development environment (<http://arduino.cc/>).

Alternately, Meggy Jr can be programmed through an AVR ISP programmer, like the USBtinyISP.

2. Computer, Internet access, USB port....

All of the software that you'll need is available online for free. You'll need a reasonably recent vintage computer (Mac, Windows, or Linux) and internet access.

Get started here: <http://www.evilmadscientist.com/go/meggyjr>

STEP 2: BILL OF MATERIALS

Line	Designation	Value	Type	QTY
1	Circuit board	Meggy Jr RGB, version 1.2		1
2	R1, R2	1 k	Resistor, 1/4 W	2
3	R3	100 ohm	Resistor, 1/4 W	1
4	R4	10 k	Resistor, 1/6 W	1
5	RB0 - RB8	620 ohm	Resistor, 1/4 W	9
6	Q0-Q8	2STX2220 (or equivalent)	PNP Transistor	10
7	J2	6-pin right-angle single-row header		1
8	J3	3-pin right-angle single-row header		1
9	L1	Magnetic buzzer/speaker	CEM-1203	1
10	U2,U3	STP16DP05B1R LED driver chips, or one of several equivalents		2
11	U1	ATmega328P-PU Microcontroller (pre-programmed in kits)		1
12	C7,C8	18 pF	Capacitor, ceramic	2
13	XTL	16 MHz	oscillator crystal	1
14	C3,C9	470 μF, 6.3 V	Cap., electrolytic	2
15	C1,C2,C4,C5,C6	0.1 μF	Capacitor, ceramic	5
16	D0-D7	3mm LEDs, yellow diffused		8
17	J1	6-pin DIL header		1
18	U4 (sockets)	8-pin SIP socket		4
19	U4	BL-M23B881RGB	8x8 RGB LED matrix	1
20	S1	Tactile Button Switch (reset)		1
21	b0 - b5	Tactile Button Switches	B3F-5050	6
22	Battery Box	3 x AAA cell with wire leads and switch		1
23	J3 (jumper)	Header jumper fits onto J3 after soldering		1
24	b0,b1	KeyCap, Round		2
25	b2,b3,b4,b5	KeyCap, Square		4
26	Rubber feet	1/16" thick by 1/4" diameter, hard urethane		4
27	Nylon Screw	3/4" x 4-40		4
28	Nylon acorn nut	4-40		4
29	Velcro Strip	~1"x2", w/ extra strength adhesive		1

This table lists the kit contents, roughly in the order of assembly. It is *not* (repeat: *not*) a set of build instructions! There are a few places where the operations and their order is important for (possibly) subtle reasons. Please follow along as we go through the steps, even if you are an expert.



For the sake of clarity, kit contents are sorted into a few different bags of parts.

Most of the parts are labeled by their line item number that appears on the from the bill of materials (←).

(While it *can* create some interesting mystery, we do not actually suggest that you dump all the parts out into a big pile. Just take them out of their bags as needed.)

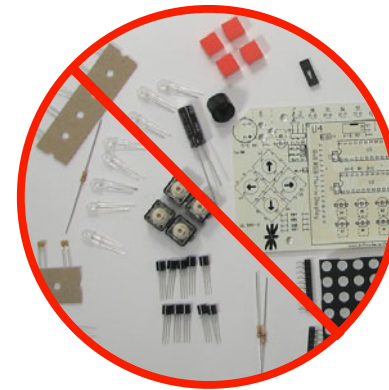

The first part on our list is #1, the Meggy Jr RGB printed circuit board:

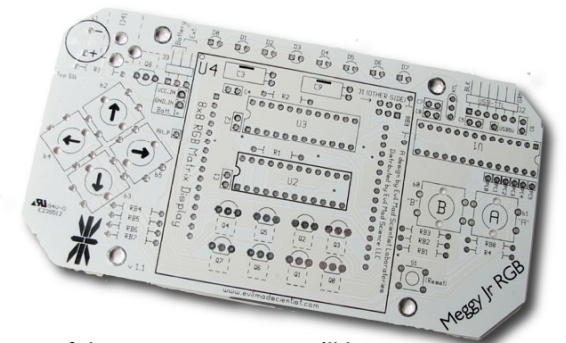

In most of the remaining steps, we'll be adding components to this circuit board.

STEP 3: ADDING FIRST COMPONENTS... (AND HOW TO DO IT!)

Part #2 is a 1 kilo-ohm resistor
(Color code: Brown-Black-Red-Gold)

Add two of these resistors to the circuit board,
in locations **R1** and **R2**.

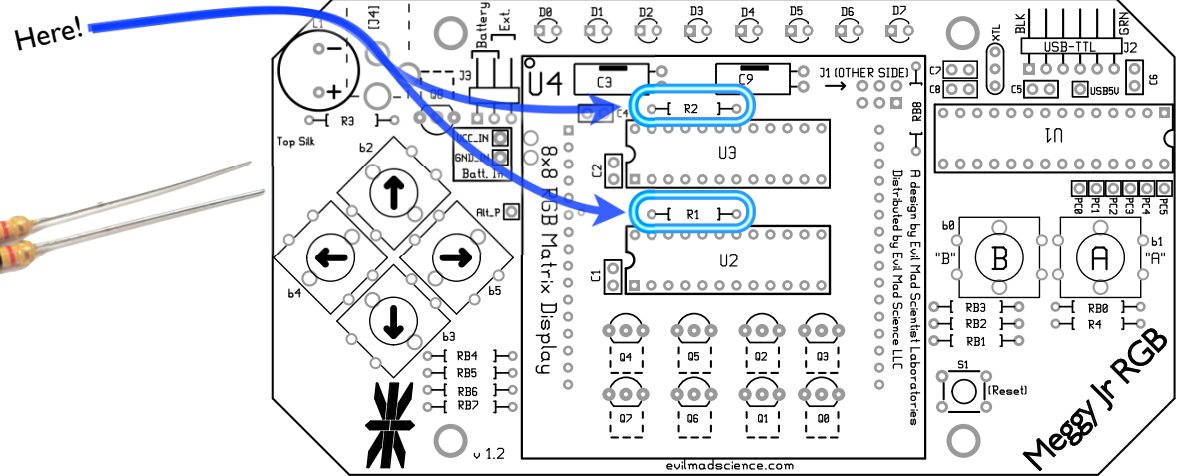

➔ Implied procedure for adding electronic components:

1. Bend the leads of components as needed.
(Resistors need to be bent, most others parts do not.
Optionally use lead forming tool shown in Step 1.)
2. Insert each component into the circuit board, from the top, at its given location. Push it flush to the board.
(Resistors are *unpolarized*; they can go in *either way*.)
3. On the back side, *gently* bend the leads out at 45° to hold components in place while you solder.
4. One at a time, from the back side, solder the leads of the component to the circuit board.

- Your tip should be shiny (tinned). If not, melt some fresh solder against it and wipe clean on a wet sponge.
- Place the solder against the joint that you wish to connect.
- Touch the iron to the solder and joint for about one second. Count it out: "one thousand one."
- The solder should melt to the joint and leave a shiny wet-looking joint. If not, let it cool and try again.

5. Clip off extra leads on back side, flush to the board.
(But not so flush that you're clipping the board itself.)

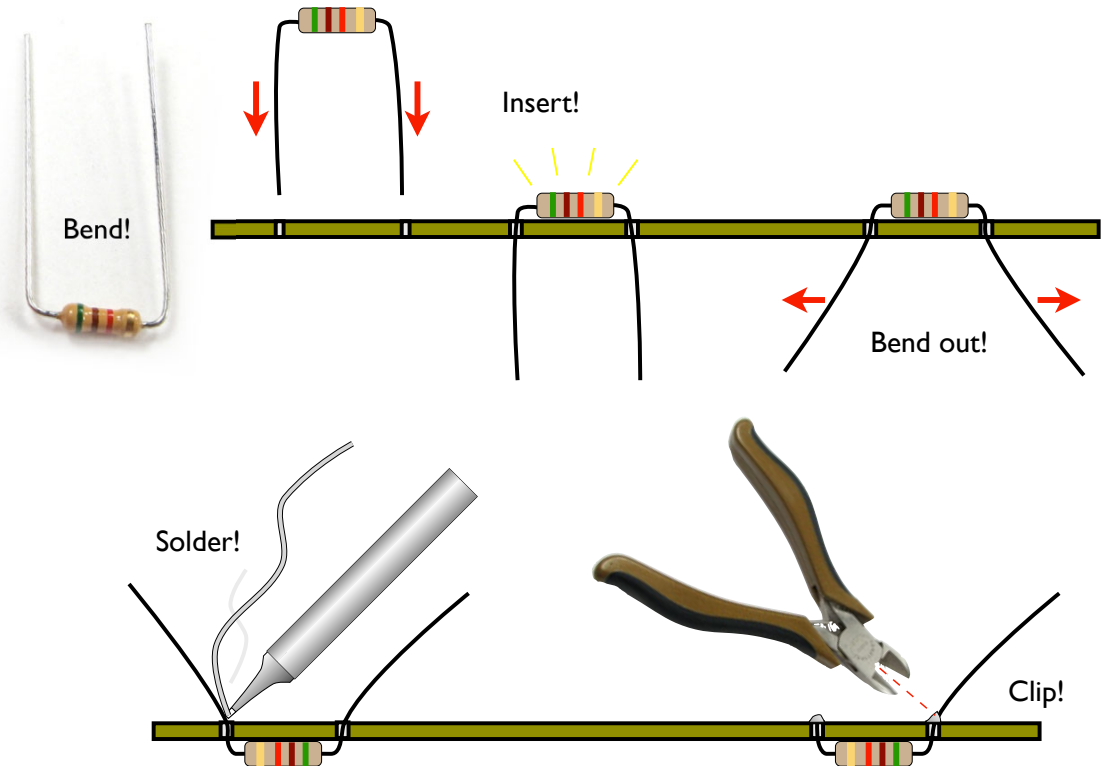

STEP 4: THE REST OF THE RESISTORS, AND TRANSISTOR PREP

Part #3 is a 100 ohm resistor
(Color code: Brown-Black-Brown-Gold)

Add one resistor to the circuit board, in location **R3**.

Part #4 is a 10 kilo-ohm resistor
(Color code: Brown-Black-Orange-Gold)

Also: it's the one smaller-size resistor!

Add one resistor to the circuit board, in location **R4**.

Part #5 is a 620 ohm resistor
(Color code: Blue-Red-Brown-Gold)

Add 9 resistors to the circuit board,
in locations **RB0** through **RB8**.

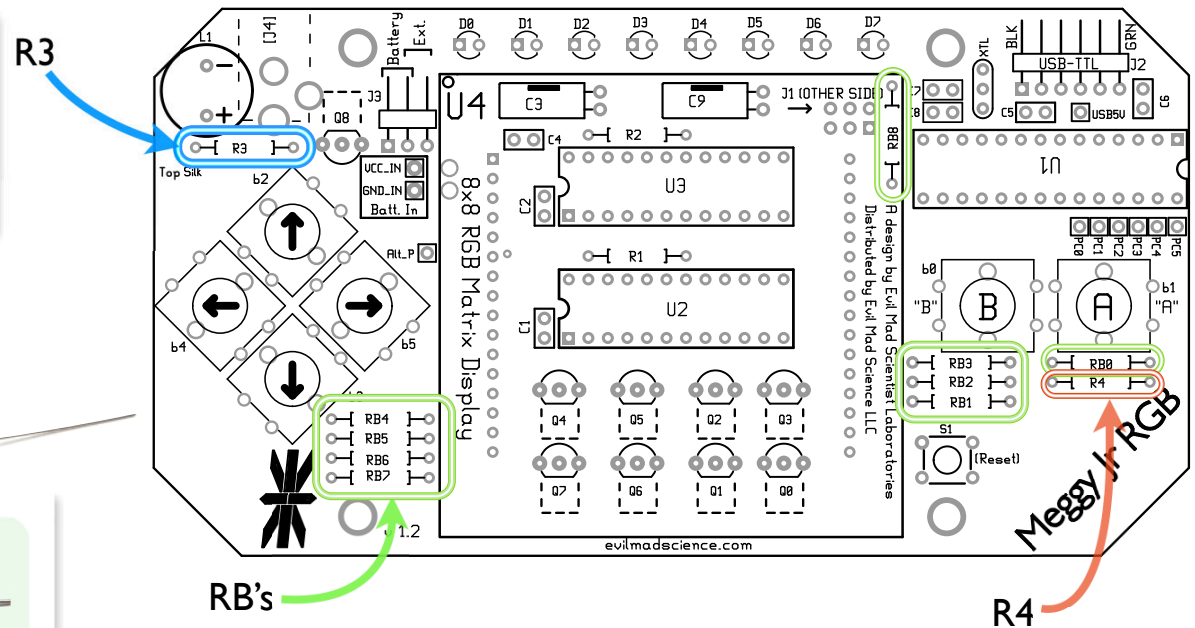

Part #6 is a transistor

You'll need nine, in locations **Q0** through **Q8**.
They need a little prep before soldering.
(Note: the kit includes one extra transistor.)

1. Orient a transistor with the flat side (the side with the writing) facing you. Grip it, very close to the top, with your fine point pliers as shown.

(Sturdy tweezers can also be used for this.)

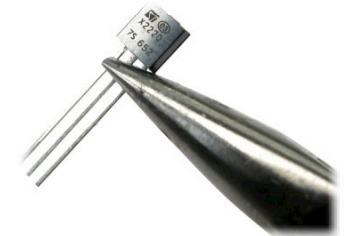

2. Bend the leads up towards you by 90°, so that they stick out straight. Then, spread the leads out slightly so that they aren't quite so close together.

(Gripping them with the pliers while doing this lets you make a tight bend with only minimal stress on the device.)

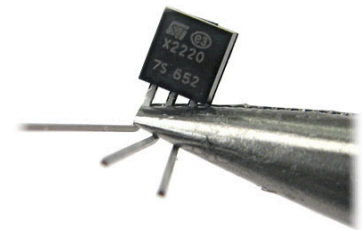

(Transistors!)
→

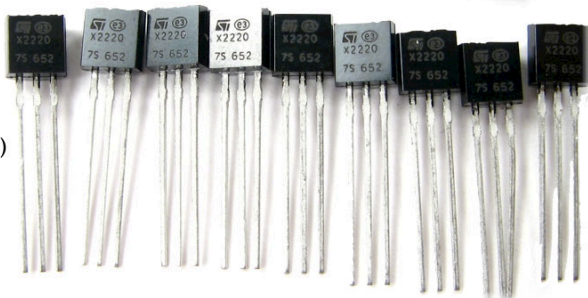

STEP 5: ADD TRANSISTORS AND PREP RIGHT-ANGLE HEADERS

Now add the transistors to the board!

In locations **Q0** through **Q8**, insert the transistors with the flat side down, all the way flush to the board. The orientation is important: The flat side should be (roughly) over the dotted-line square that contains the component name. Solder in place all three pins of each transistor and trim their leads.

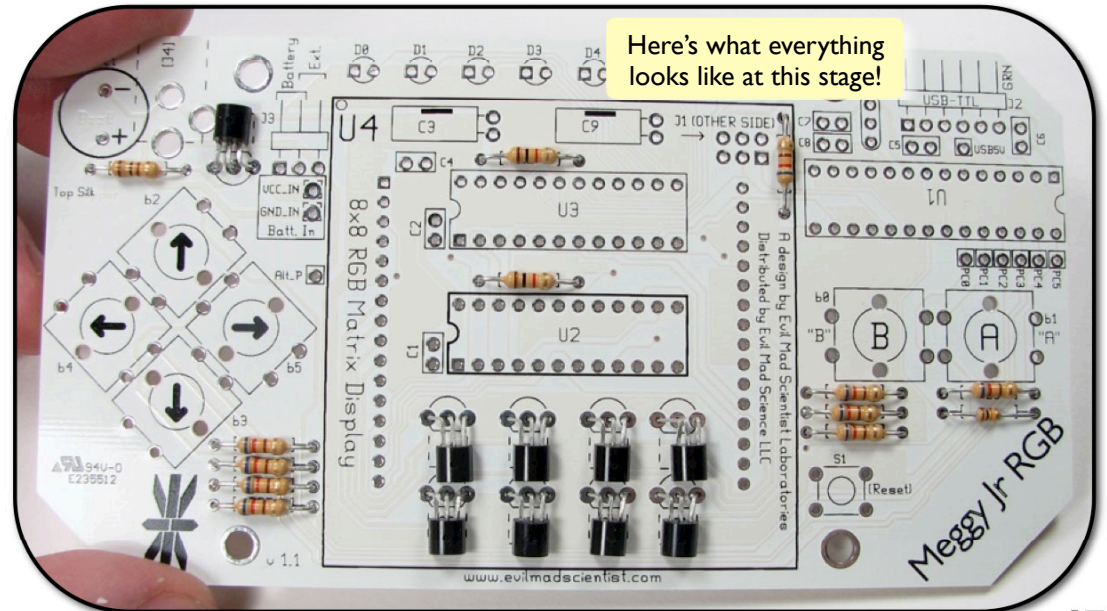
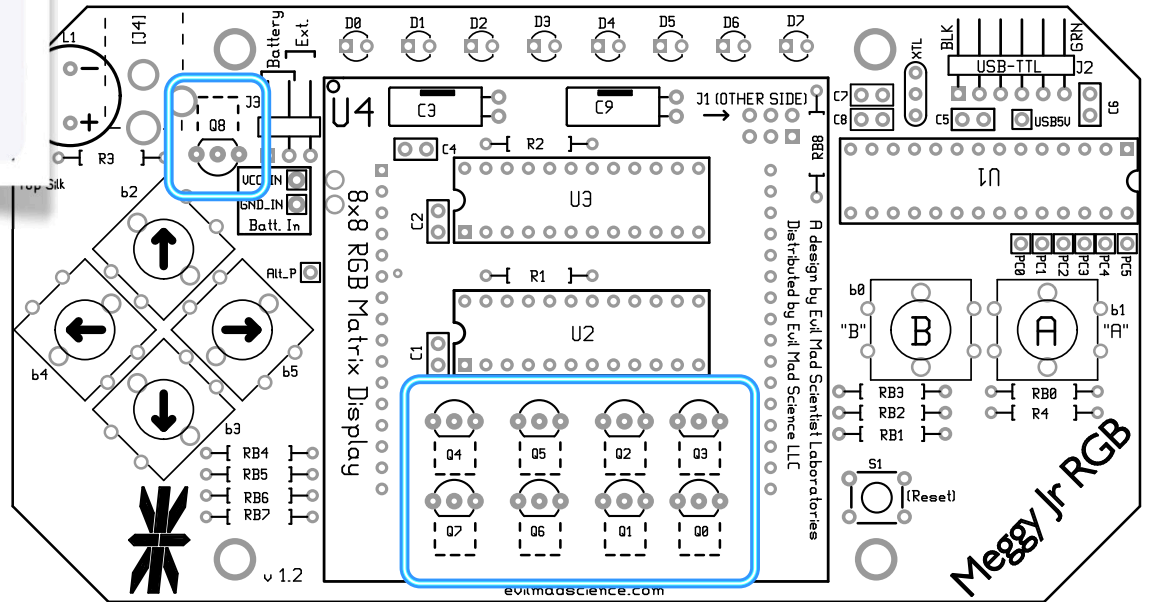
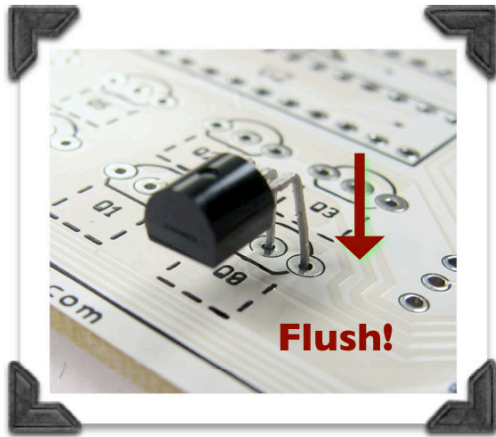

STEP 6: ADD RIGHT-ANGLE HEADERS AND SPEAKER

Add right-angle headers #7 & #8

Add the 6-pin header in location **J2**, and the 3-pin header in location **J3**. The pins fit loosely in the holes, and *should not be bent*. It may be helpful to tack these parts in place with a piece of tape (touching the plastic part only) while you solder the first pin of each.

Check after soldering the first pin to make sure that the header pins are level to the board.

(Note: The pins on the bottom side are already short and do not need to be trimmed shorter.)

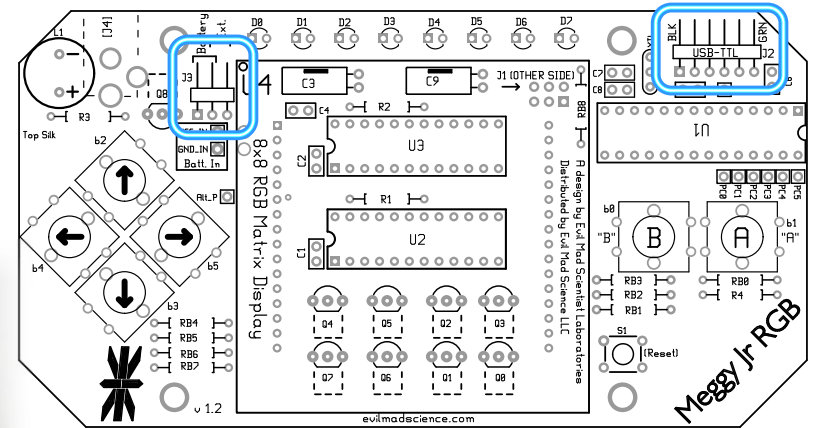
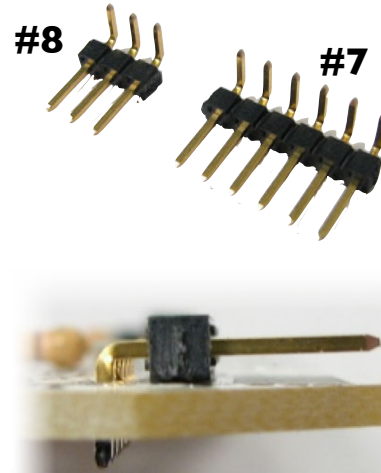

Part #9 is a magnetic speaker/buzzer.

Add this component to location **L1** in the upper left corner of the circuit board.

The speaker has a marking on the top (“+”) to indicate its orientation. There are also corresponding marks on the bottom side for + and -.

Insert the speaker into the board with the “+” pin into the matching “+” labeled hole on the circuit board. Press it flush to the board and solder it in place.

(+/- markings!)

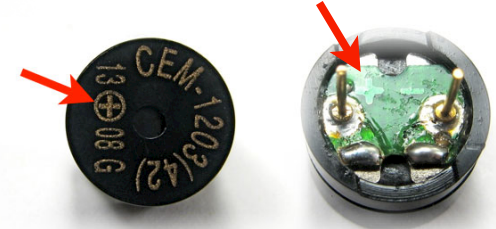

Part #10 is an LED driver chip.

(Type STP16DP05B1R, or compatible)

There are two of these chips, which go in locations **U2**, **U3**. Your kit may use a different brand of driver chip, but there will only be two chips with the right number of legs to fit into locations U2 and U3.

First, locate these chips. Then, figure out which way is which on the chips.

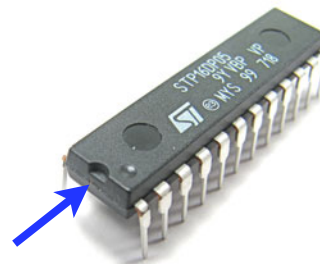

The most important feature to notice on the chips is the “half-moon” indentation at one end of the chip. This is the polarity marker. (Other markings on the chips may vary.)

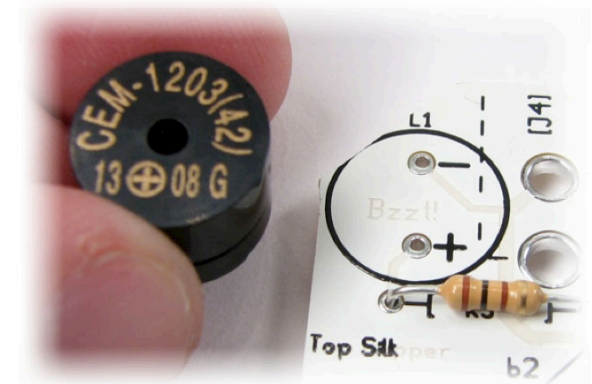

STEP 7: ADD THE CHIPS

Now add the LED driver chips, **U2**, **U3**.

Orientation-- *very important*-- Half-moon end of chip matches that of the drawing on the circuit board

The chips should easily slip into the board. If necessary, bend the leads of the chip to straight up and down before inserting the chip. Do not bend them by hand; bend all pins on one side at a time by pushing them against a hard flat surface.

From end of chip:

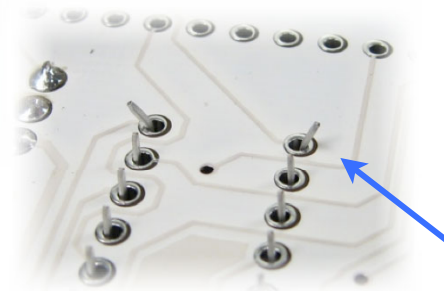
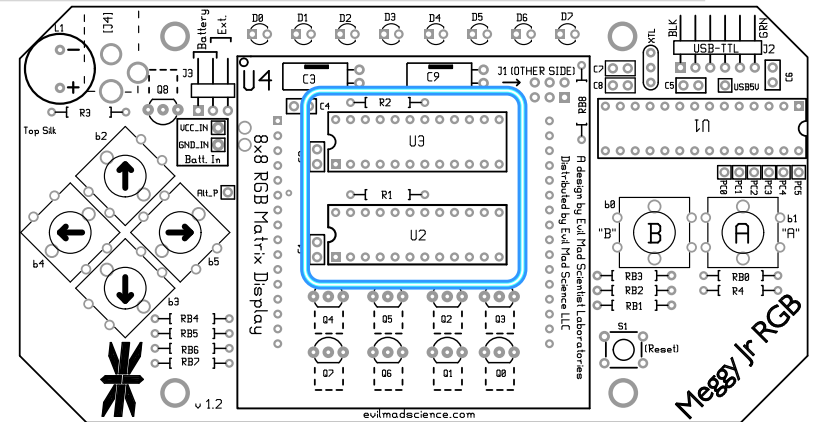
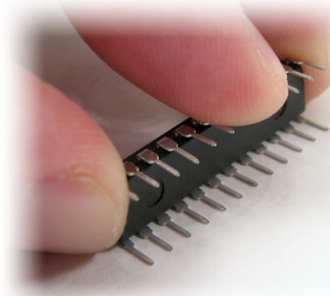

Press the chips flush onto the circuit board and solder them in place. You will be soldering directly to the pins of the chips, so try to keep your soldering time to about one second per pin.

(See also soldering tips in Step 3.)

To keep the chips in place while you solder, slightly bend out the corner pins on the back side of the circuit board.

Part #11 is the microcontroller.

Add the pre-programmed ATmega328P microcontroller in location **U1**. Again, pay close attention to the orientation of the device on the board, matching the half-moon end of the chip to the half-moon shape on the printed circuit board.

In particular, note that this chip is *upside down* with respect to the other two chips-- the label "U1" is written upside down to emphasize that point.

As with the last chips, press this one flush onto the board and solder it into place.

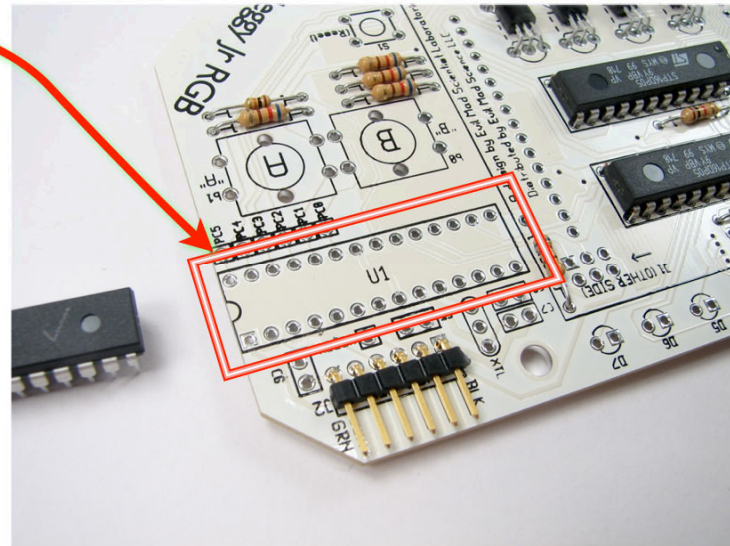

STEP 8: CRYSTALS & CAPS

Part #12 is an 18 pF ceramic capacitor

Add two capacitors at locations **C7** and **C8**.
(Like resistors, you can put these in either way.)

Note: The labels on these tiny capacitors are *invisibly small*-- they are the two little caps that are bagged and/or taped together, marked with a black stripe.

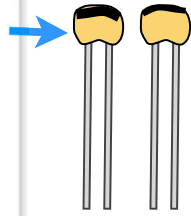

Upper right corner of circuit board:

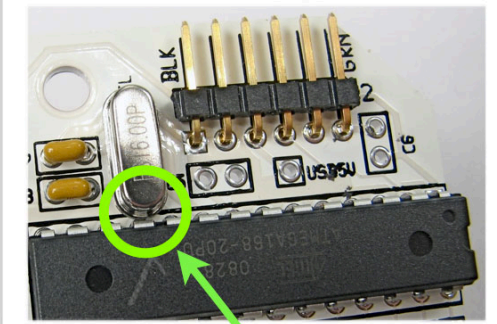
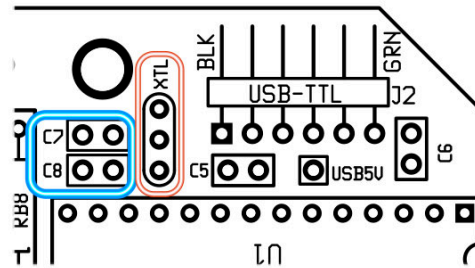

Part #13 is a 16 MHz crystal oscillator

A shiny steel can. Install this component in location **XTL** on the circuit board, flush to the board as usual. The two pins go in the outer two holes of location XTL; you can ignore the middle hole. (Orientation: Either way.)

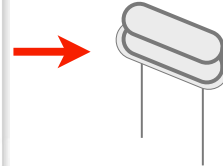

Note: The side of the crystal oscillator may (or may not) rub up against one pin of the microcontroller (U1). This is not a concern in either case.



Part #14 is a 470 μ F capacitor

After a little prep, two of these components will be installed in locations **C3** and **C9**.

Orientation matters: the *negative* side of each capacitor is marked with a broad white stripe.



1. Orient one of the capacitors with the negative side (the side with the broad stripe) facing you, and the leads on the left side.



2. Grip it, near the top of the leads, with your fine point pliers.

3. Bend the leads down 90°, so that they stick straight down.

(Gripping them with the pliers while bending lets you make a tight bend with only minimal stress on the device.)

4. Repeat this procedure for the other capacitor.

STEP 9: THE CAPACITORS STRIKE BACK

Add the properly bent capacitors in location **C3** and **C9**.

The capacitors are larger than the outline of the drawing on the circuit board but will still fit in place. Be sure that the negative side of the capacitor goes to the side marked “-” on the circuit board.

Push the capacitors flush to the circuit board and solder them in place.

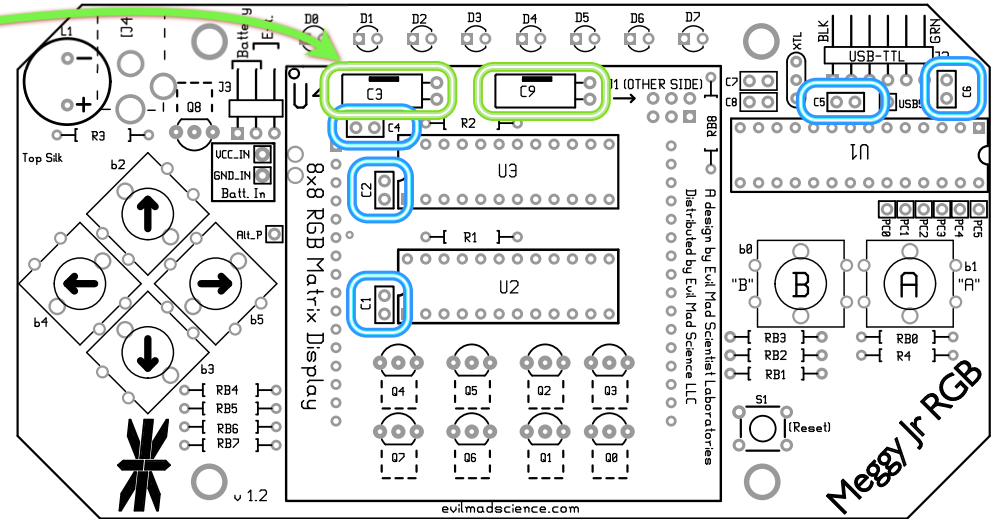
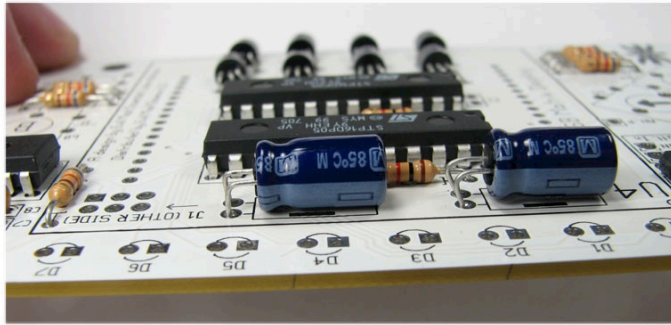

Part #15 is a 0.1 μF ceramic capacitor

Add five of these capacitors, in locations **C1**, **C2**, **C4**, **C5** and **C6**. (Orientation: Either way.)

Again, the labels are tiny. If your eyes are very good, you *might* be able to make out the legend “104” on these. But no need. :)

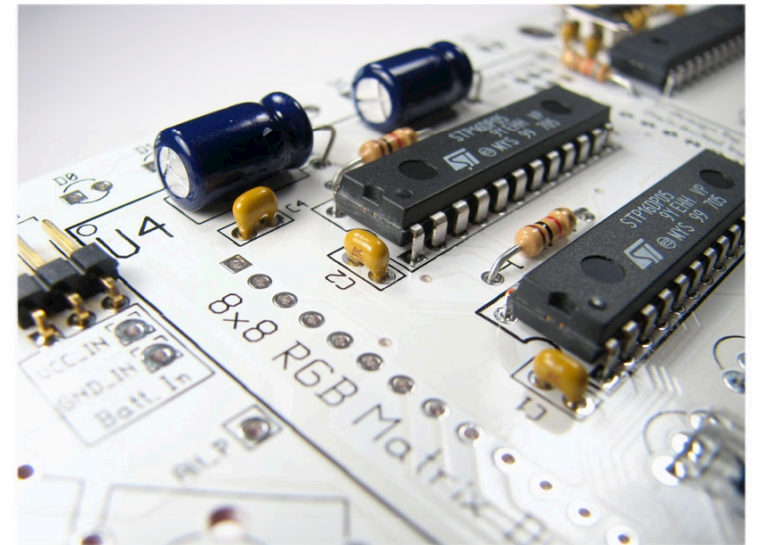
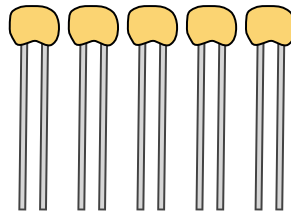

STEP 10: LITTLE LEADS & OPTIONAL ISP CONNECTOR

Part #16 is a tiny 3mm diffused yellow LED

We're adding 8 of these LEDs to the board, in locations **D0** through **D7**.

The orientation matters. Each LED has a *flat facet* on the plastic top on one side. That side also has a *short lead*. This side of the LED goes into the *round hole*.

The other side has a *long lead* and goes to the *square hole*.

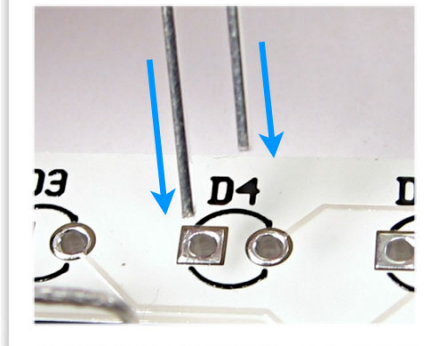

Like so: Long lead (first!) into the square hole.

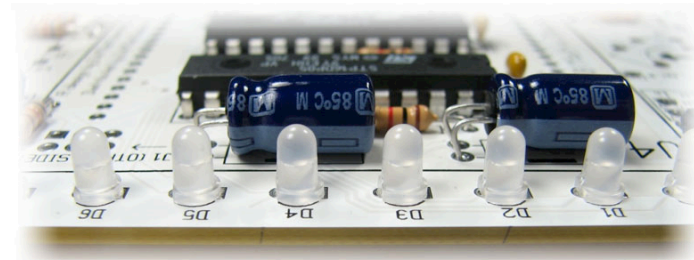
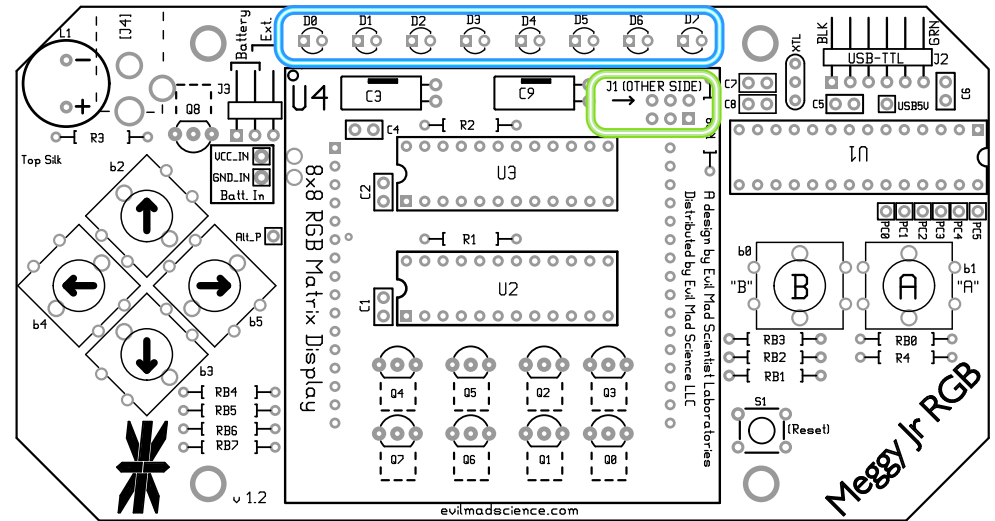

Then push the LEDs flush to the board and solder them in place.

Part #17 is a 6-pin dual inline header

>>An *OPTIONAL PART* that most users *SHOULD NOT INSTALL*.

(It's an auxiliary programming port for use with AVR ISP programmers. *Do not* add this to your circuit board *unless* you already have *and plan to* use an ISP programmer. It is not needed for using Meggy Jr or for programming through a USB-TTL cable.)

If you're *really sure* that you need it, add it on the *back side* of the circuit board, underneath marked location **J1**.



Marking on the top side

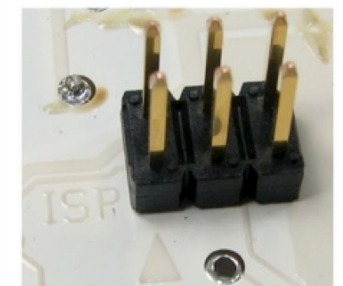

Installed on bottom side (Pin 1 is marked.)

STEP 11: SOCKETING THE LED MATRIX DISPLAY

Parts #18 & #19: LED display and its sockets

The 8x8 LED matrix display sits in a set of socket strips on the circuit board at location U4.

It has *lots* of pins, so it can (potentially) be difficult to insert into a socket. To make it much easier, we'll instead *add the sockets to the display* and do so in small segments.



#18: 8-pin "SIP" socket strips
(4 pieces)



#19: 8x8 RGB
LED Matrix Display

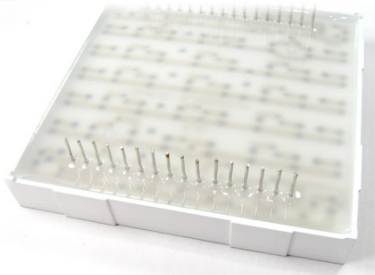

1. Start with the LED matrix display upside down. To avoid scratching the black paint on the front, set it on a clean soft surface like a piece of paper. (If these instructions are printed out, this page will do nicely!)

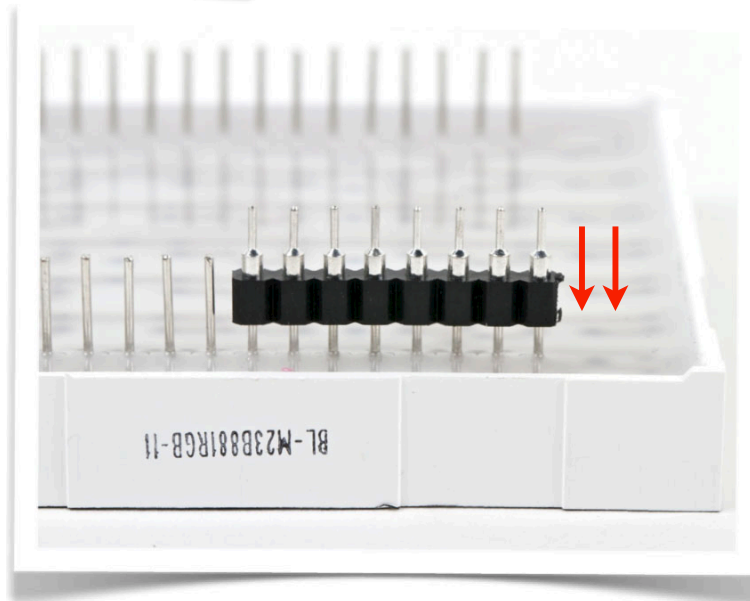

2. With (a bit of wiggle and) firm even pressure, slide one of the four socket strips onto the LED display pins as shown. The 8-pin socket strip goes over 8 pins of the display, (one half of the 16 pins on one side).

Important: The socket strip needs to go as far down onto the pins as shown-- it should *not* sit near the top of the pins.

If the LED display pins are initially bent a bit away from vertical, you may need to *gently* adjust them to help the socket strip fit on neatly.

3. Add the other three socket strips to the LED display the same way.

This completes the socket assembly; next, we'll add it to the board!

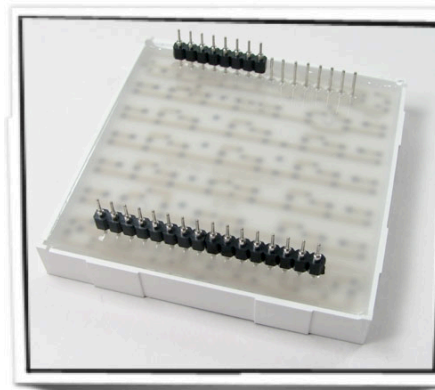

STEP 12: ADD THE SOCKETED LED MATRIX DISPLAY AND THE BUTTON SWITCHES

Add the socketed display in location **U4**.

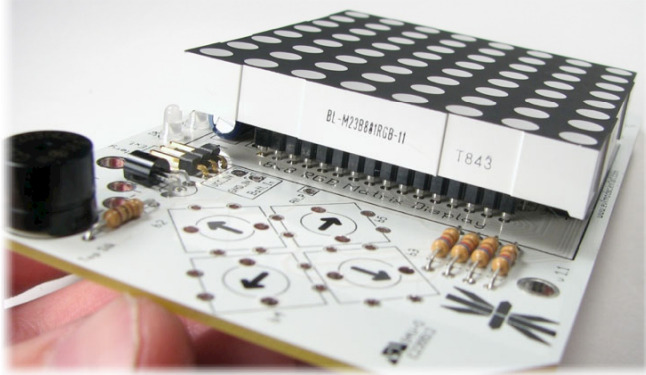

U4, Oriented with label **HERE**:

Set the socketed display into its position (U4), with the labeled edge on the left side as shown.

Position the display flat on its sockets; you may need to push C3 and C9 flush to the board for this.

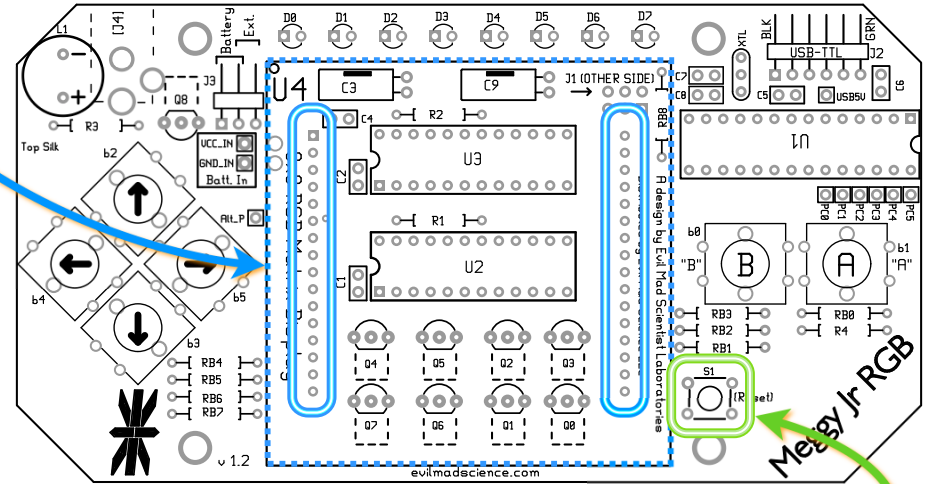

Turn it up side down onto a flat surface. Holding the circuit board *LEVEL*-- judging by how far the different pins stick through-- first solder one of the corner pins, to tack the display in place. Verify from the top side that the LED display is level before proceeding to solder the rest of the pins.

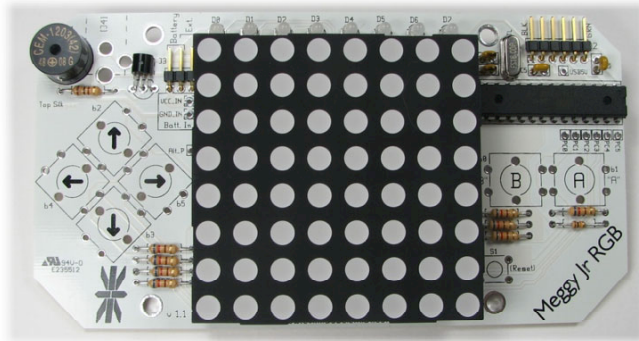

(Almost there!!!)

After the socket pins are soldered in place, the LED display can-- if necessary-- be removed (with a careful and firm rocking motion) and put back in place.

Part #20 is a small tactile button switch.



This is an *OPTIONAL PART* that is not required (but might be nice).

If installed, the Meggy Jr RGB will be reset (i.e., rebooted) when you push this button. If you want it, *snap* it into location **S1** (Reset), and solder all four pins from the back side.

Part #21 is a large tactile button switch.

Six of these *snap* into locations **b0** through **b5**: the gameplay button locations. Each has six pins: four metal pins and two plastic pins that help keep it in place.

Be careful! When this snaps into the board, those metal pins can poke you, so don't put your fingers right where it will snap through. Solder the four metal pins, but not the two plastic ones. You don't need to *fill* the holes with solder; a simple connection is good enough.

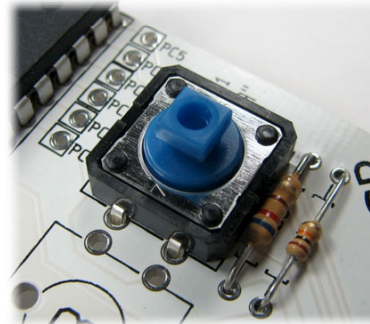

STEP 13: WIRE THE BATTERY BOX

Part #22 is a 3 x AAA battery box w/ switch

The wires from the battery box go to the holes that are (on the top of the board) labeled VCC_IN (red wire) and GND_IN (black wire).

They first pass through the board *from the back side*, through a pair of “strain relief” holes, then back down, and are then soldered on the back side, in the normal way.

The wires supplied are longer than necessary, given the position that the battery box sits in (see step 16). But, if you happen to have a pair of wire strippers handy, you can cut the wires a bit shorter before attaching them-- do not cut them shorter than 4 inches (10 cm).

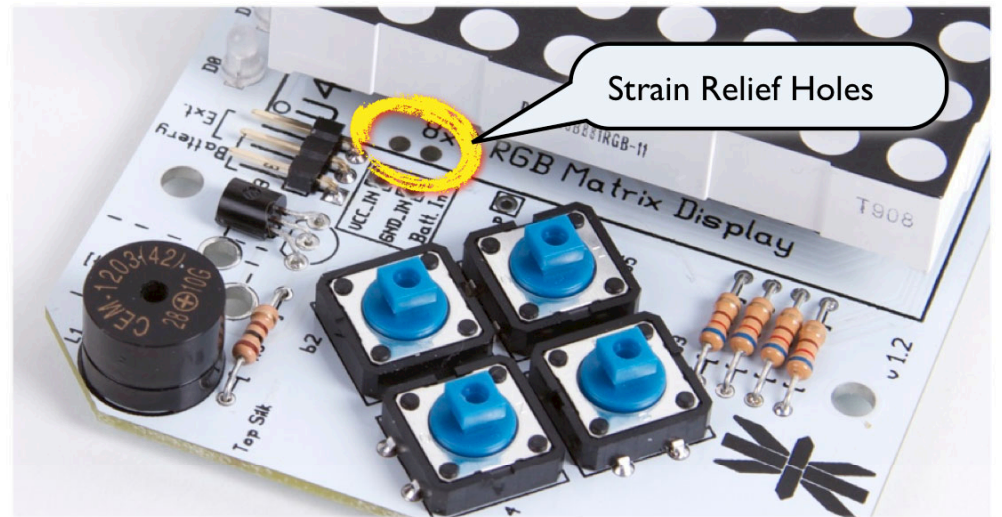

Pull wires up through strain relief holes first

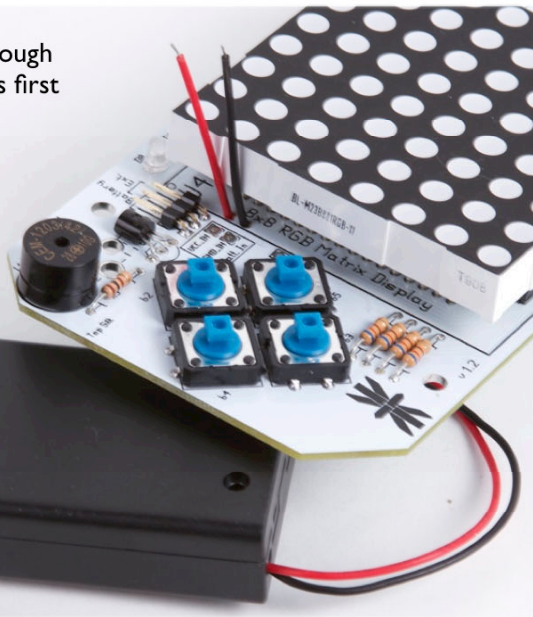

After pulling wires up, loop them back down, into VCC_IN (red wire) and GND_IN (black wire).

Solder the two wires in place, and pull any slack back down through the strain relief holes.

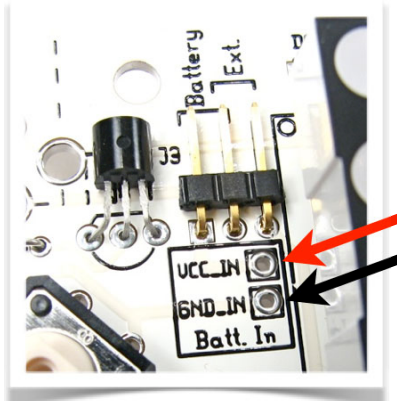
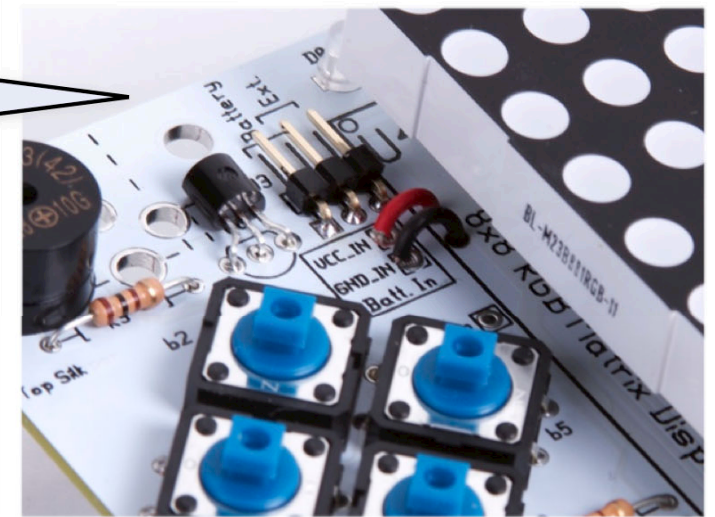

Pro tip: If your battery box is held together with a small screw, remove that screw and throw it away.

STEP 14: POWER SOURCE JUMPER, BUTTON CAPS & RUBBER FEET

Part #23 is a small header jumper

Connect the jumper over the left two pins of J3 when running Meggy Jr off of batteries, or over the two right pins to draw power from an external source like an ac adapter.

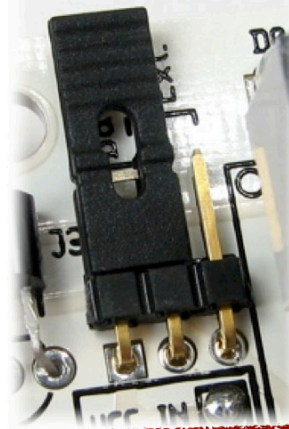

Note: J4 is a location to install a power jack on the reverse side of the board. Your ac adapter should output for 4.5 - 5V dc, regulated, center-positive, with at least 600 mA capacity.



Parts #24 & 25 are molded button key caps

These six button caps *snap* onto the large tactile button switches, in the locations shown.

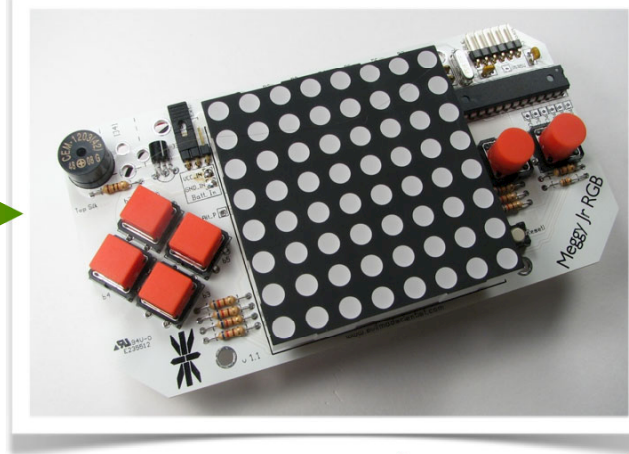

Meggy Jr RGB is designed to be mounted and used inside a handle set (case) that protects the circuit board from your fingers, and protects your fingers from the circuit board. Parts #26-28 are mounting hardware for attaching these handles.

Templates to make your own handle sets are available in the Meggy Jr RGB documentation.



Part #26 is a hard urethane rubber foot

Install these four clear rubber bumpers to the bottom of the circuit board, on flat parts of the board close to the four screw hole locations. (Suggested locations are shown in circles.) These help to keep the plastron in the correct place and reduce its total flexing.

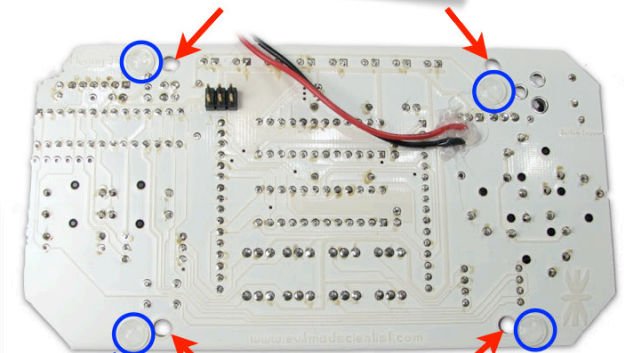

Screw hole locations (arrows)

STEP 15: PUTTING MEGGY JR IN THE HANDLE SET

Parts #27 & 28 are nylon screws and acorn nuts

These parts are used to attach the upper and lower shell of a handle set. Use no tools with these! Hand tighten, only as much as needed, by turning the acorn nut. Over-tightening could easily crack the plastic of the handle set.

Mounting the handle set

The top shell of the handle set (the *carapace*) fits neatly over the LED display, with cutouts for the speaker, buttons, and screw holes. Drop the four nylon screws through the screw holes to help index the lower shell.

The lower shell (the *plastron*) fits on the bottom side with cutouts for the battery box, the battery box wires, as well as the optional ISP connector and power jack. Use the nylon screws from the top side to help guide the lower shell into place, and secure it in place -- gently-- with the nylon acorn nuts.

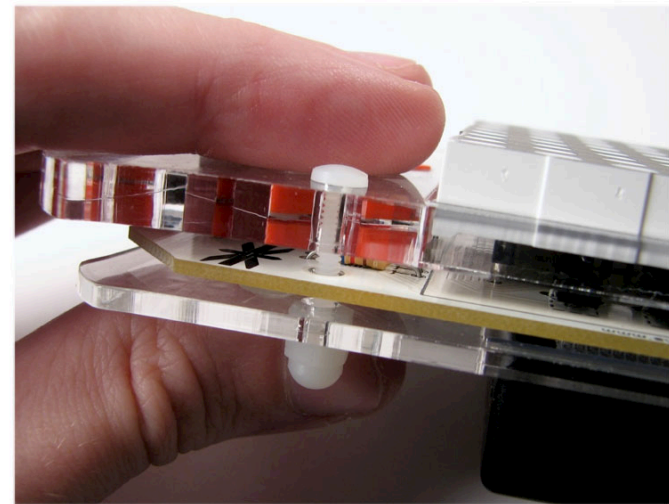
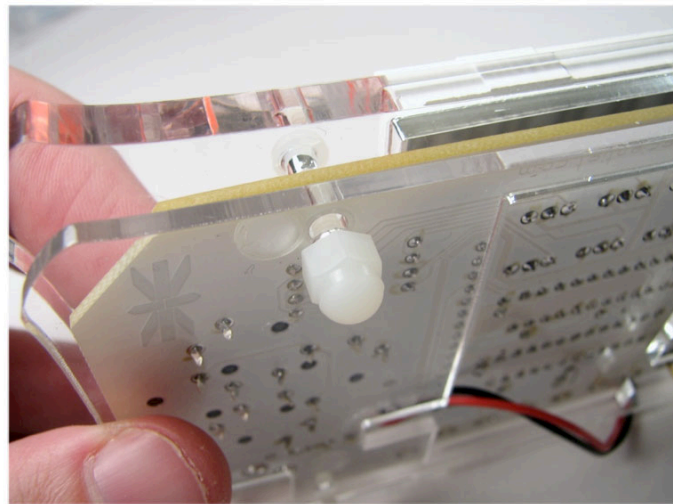
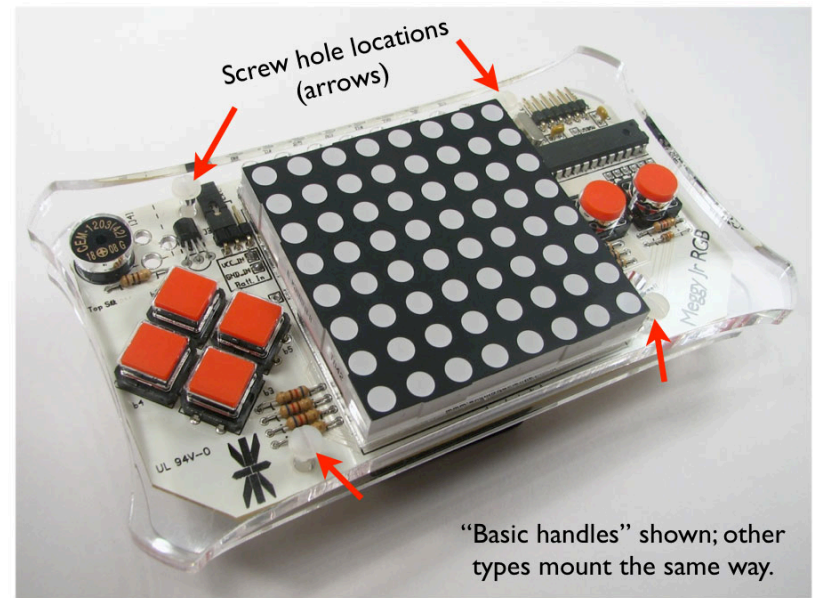

Part #29, the *last part*, is an adhesive Velcro strip

A strip of velcro with high-strength adhesive is provided to attach the battery box to the back side of the Meggy Jr circuit board.

Before adding the Velcro...

- (1) Test your Meggy Jr to make sure that it's working correctly,
- (2) Trim very short the leads of components that stick up where the velcro will go, and
- (3) Figure out exactly where you'll be routing the battery box wires.

If you have not shortened the leads from the battery box, you can route them under the velcro as shown to take up some of the slack and provide strain relief.

When you are ready, attach the hook side of the velcro to the battery box-- the side *without* the switch-- and the loop side to the circuit board.

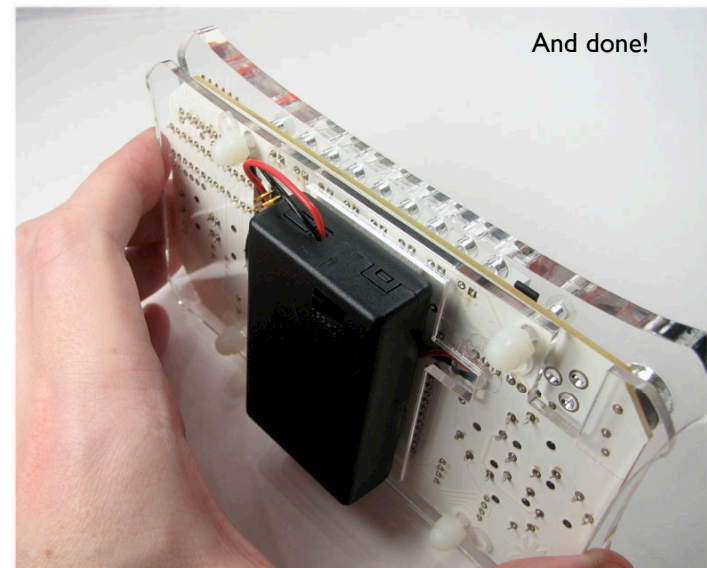
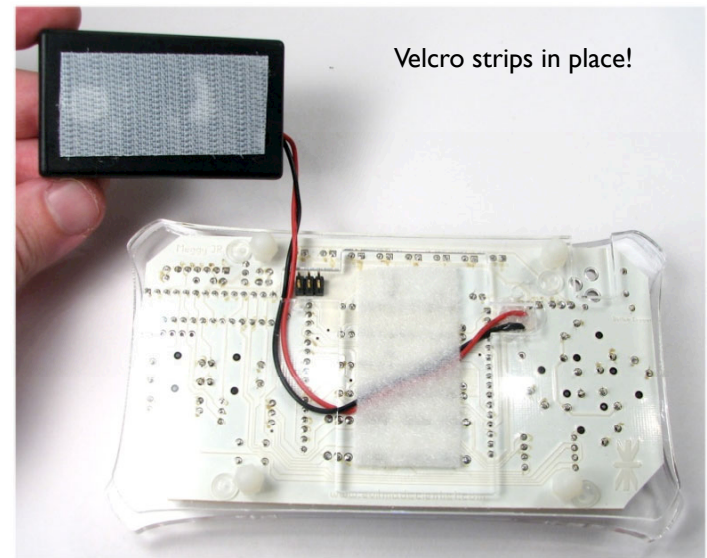

Programming Meggy Jr RGB

Meggy Jr RGB can be programmed through the Arduino development environment (available at <http://arduino.cc/>), for which we recommend using the USB-TTL cable from Step 1.

This cable connects to J2 as shown at right, with the green-wire end to the side marked “GRN” on the circuit board and the black-wire end to the side marked “BLK” on the circuit board. You must power on Meggy Jr from battery or an external dc power adapter while programming through the USB-TTL cable; that cable does not provide power to Meggy.

An Arduino environment library with example code is available. Or, if you want to start from scratch, you can start by looking at the circuit diagram and go from there. The ATmega328P microcontroller can also be programmed through a standard AVR ISP programmer and the AVR-GCC toolchain, if that’s your preferred environment.

To get started, see our guide to programming Meggy Jr:
<http://www.evilmadscientist.com/go/meggyjrlib>

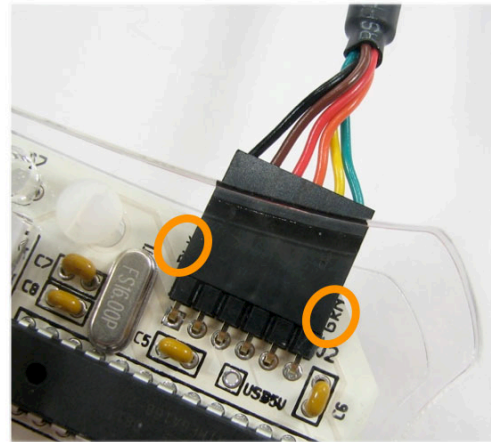

Just want to play existing games? Sure!

1. Read pages 1-3 of the programming guide, to learn how to send programs to Meggy Jr RGB.
2. Find new games and download them! Check out the Meggy Jr RGB project links available from our documentation wiki:
<http://wiki.evilmadscience.com/MeggyJrRGB>

Need help?

If you encounter difficulty with Meggy Jr RGB in hardware, software, or elsewhere, odds are that somebody knows how to help you out. Your first stop should be the Evil Mad Scientist Laboratories forums:
<http://www.evilmadscientist.com/forum/>

There’s also a “developer” mailing list, at
<http://groups.google.com/group/meggydev>

Additional documentation and resource links are posted on our wiki, at:
<http://wiki.evilmadscience.com/MeggyJrRGB>

An open-source project

The hardware and software designs used in this project have been released under an open-source license. For more information, please see: <http://www.evilmadscientist.com/go/meggyjr>

Example firmware and contributed programs are available for download. Your own code contributions, handle designs, and games are welcome too-- we’d love to see what you can do with it!
 Productive hacking is strongly encouraged. :)

Got pictures?

If you have interesting pictures or video of things built using this kit or the hardware or software designs, we’d love to see them in the Evil Mad Science Auxiliary:
<http://www.flickr.com/groups/evilmadscience/>